

The advertisement features a minimalist, modern aesthetic. The background is a light blue and white gradient with soft, curved shadows. In the foreground, a large, white, curved object, possibly a bathtub or a large bowl, is partially visible. To its right, a smaller, white, curved object is shown. In the lower right corner, a small, red, bowl-shaped object is prominently displayed. The text 'victoria + albert' is centered in the upper half, with a registered trademark symbol. Below it, the text 'volcanic limestone baths' is centered.

victoria + albert®

volcanic limestone baths

A DISTINCTIVE MEMBER OF THE HOUSE OF ROHL



HOUSE OF ROHL

L'HISTOIRE QUE RACONTE L'ARTISANAT

Victoria + Albert est membre de House of Rohl, une collection de marques artisanales reconnues pour leur art et leur héritage.

La famille Rohl a passé sa vie à chercher des histoires de dévouement, de passion et d'artisanat. Ils ont rassemblé diverses marques, exceptionnelles dans leur catégorie, qui se complètent les unes des autres, des esprits indépendants, mais des valeurs communes, la conviction que la qualité commence avec le matériau, que le design est dans le détail et que l'artisanat est primordial.

Les belles histoires sont celles qui rendent la vie exceptionnelle.

Chez House of Rohl, nous découvrons un artisanat traditionnel, révélant des histoires uniques : Histoires de lieux et de provenance, des histoires d'ingéniosité et d'invention, des histoires sur la recherche incessante de la perfection.

Bienvenue chez House of Rohl®

DAS HANDWERK ERZÄHLT DIE GESCHICHTE

Victoria + Albert ist Teil von House of Rohl, einer Kollektion handwerklicher Marken, anerkannt für ihr Design und ihre Geschichte.

Die Familie Rohl suchte ein Leben lang nach Geschichten, geprägt von Engagement, Leidenschaft und Handwerklichkeit. Es entstand eine Kollektion verschiedener Marken, alle außergewöhnlich in ihrem Wesen, die sich ergänzen. Unabhängige Seelen, aber gemeinsame Werte. Der Glaube, dass Qualität mit dem Material beginnt, Design im Detail liegt und die Handwerkskunst an erster Stelle steht.

Besondere Geschichten machen das Leben außergewöhnlich. Im House of Rohl entdecken wir alterwürdige Handwerke und enthüllen verborgene Geschichten. Geschichten der Orte und der Herkunft. Geschichten von Einfallsreichtum und Inspiration. Geschichten nach einem unermüdlichen Streben nach Perfektion.

Willkommen im House of Rohl®

LA STORIA DELL'ARTIGIANATO CI RACCONTA

Victoria + Albert è membro di House of Rohl, una collezione di marchi dell'artigianato riconosciuti per la loro qualità e tradizione.

La famiglia Rohl ha dedicato un'intera vita alla ricerca di storie di dedizione, passione e artigianato. Loro hanno raccolto insieme diversi marchi, eccezionali nella loro categoria, che si complimentano fra di loro. Spiriti indipendenti, ma valori condivisi. La convinzione che la qualità incominci dal materiale, il design e nei dettagli e l'artigianato fondamentale.

Le storie distintive sono ciò che rende la vita eccezionale. Alla House of Rohl, scopriamo storie di radici e tradizioni. Storie di creatività e innovazione. Storie di una continua ricerca della perfezione.

Benvenuti nella House of Rohl®

HET VERHAAL CRAFT VERTELT

Victoria + Albert is onderdeel van The House of Rohl, een collectie van ambachtelijke merken met een erkende reputatie voor hun kunstzinnigheid en traditie.

De familie Rohl zoekt al jaren naar verhalen van toewijding, passie en vakmanschap. Ze hebben diverse merken bijeengebracht, uitzonderlijk in hun categorie, die elkaar aanvullen. Onafhankelijke handelsmerken, maar met gemeenschappelijke waarden. Een overtuiging dat kwaliteit begint bij het materiaal, design dat in het detail zit en waar vakmanschap het allerbelangrijkste is.

Onderscheidende verhalen zijn wat het leven uitzonderlijk maakt. In the House of Rohl ontdekken we eeuwenoude ambachten en en tonen we verhalen die anders zijn dan alle andere. Verhalen over locatie en herkomst. Verhalen over vindingrijkheid en creativiteit. Verhalen van een niet te stuiten streven naar perfectie.

Welkom bij the House of Rohl®

PERRIN & ROWE | RIOBEL
SHAWS | VICTORIA + ALBERT

Explore the collection at houseofrohl.uk

Contents

Introduction

A lifetime of luxury bathing.....	4
What is QUARRYCAST™ ?.....	6
What are the benefits of QUARRYCAST™?.....	8
Colour collaboration with Wallpaper*.....	10
Petite luxury.....	12
Refined designs.....	14

Baths

Baths with void space.....	18
Amalfi.....	20
Amiata collection.....	24
Barcelona collection.....	30
Cabrits.....	40
Cheshire.....	44
Drayton.....	48
Edge.....	52
Eldon.....	56
Elwick.....	60
Hampshire.....	64
ionian.....	68
ios.....	72
Marlborough.....	76

Monaco.....	80
Mozzano collection.....	84
Napoli.....	90
Pembroke.....	94
Pescadero.....	98
Radford.....	102
Ravello.....	106
Richmond.....	110
Roxburgh.....	114
Shropshire.....	118
Taizu.....	122
Terrassa.....	126
Toulouse collection.....	130
Trivento.....	136
Vetralla collection.....	140
Warndon.....	146
Wessex.....	150
Worcester.....	154
York.....	158

Built-in Baths

Kaldera collection.....	164
-------------------------	-----

Basins

Amalfi 55.....	172
Amiata 60.....	174
Barcelona 48.....	176
Barcelona 55.....	178
Barcelona 64.....	180
Cabrits 55.....	182
Drayton 40.....	184
Edge 45.....	186
ios 54.....	188
ios 80.....	190
Maru 42.....	192
Napoli 57.....	194
Radford 51.....	196
Ravello 60.....	198

Recessed Basins

Kaali collection.....	202
Kaldera collection.....	210
Lario 100 Solo.....	214
Mandello 114 Solo.....	216
Pembroke 52.....	218
Rossendale collection.....	216

Washstands & Mirrors

Candella collection.....	228
Metallo collection.....	232
Anatolia collection.....	240

Waste Kits

Basin Wastes.....	246
Basin Bottle Traps.....	248
Bath Wastes.....	250

Accessories

Tombolo.....	260
Backrests.....	263
Headrests.....	264
Handles.....	265
World showcase.....	266
A world of colour.....	278
Special orders.....	280
QUARRYCAST™ finishes.....	282
Next steps.....	284
Terms & conditions.....	286
House of Rohl.....	288



- FR Sans trou de trop-plein.
- DE Ohne Überlauf.
- IT Senza foro per troppo pieno.
- NL Zonder overloopgat.



- FR Avec trou de trop-plein.
- DE Mit Überlauf.
- IT Con foro per troppo pieno.
- NL Met overloopgat.

A lifetime of luxury bathing

Victoria + Albert baths est né d'une passion pour les baignoires de luxe.

La vision était simple : devenir une référence en matière de style, d'innovation et de performance dans le domaine de la salle de bains. Aujourd'hui, 25 ans après la création de Victoria + Albert, nos baignoires et nos lavabos primés se trouvent dans certaines des maisons et des hôtels les plus prisés du monde.

Le luxe est dans les détails. De la qualité de l'artisanat et des matériaux utilisés, à l'assistance des professionnels qui composent notre service clientèle. Nous livrons dans le monde entier, chaque commande est expédiée rapidement depuis nos centres de distribution internationaux. Avec la tranquillité d'esprit d'une garantie domestique de 25 ans*, choisir Victoria + Albert est un investissement pour la vie.

Victoria + Albert Wannen sind das Ergebnis einer Leidenschaft für luxuriöses Baden.

Die Vision war ebenso einfach wie kompromisslos: die Standards für Stil, Innovation und Leistung bei Badezimmerprodukten vorzugeben. Heute, 25 Jahre nach der Gründung von Victoria + Albert findet man unsere preisgekrönten Wannen und Waschbecken in einigen der begehrtesten Häusern und Hotels der Welt.

Luxus steckt im Detail. Das beginnt bei der hochwertigen Handwerkskunst und den verwendeten Materialien und endet bei den hilfsbereiten Experten in unseren Kundendienst-Teams. Wir liefern weltweit und versenden jede Bestellung schnellstmöglich von unseren internationalen Vertriebszentren aus. Dank einer 25-Jahre währenden Garantie bei privater Nutzung ist die Entscheidung für Victoria + Albert eine Entscheidung fürs Leben.

Le vasche da bagno Victoria + Albert nascono da una passione per i bagni di alto livello.

L'idea era chiara: definire lo standard di innovazione, stile e performance nei prodotti da bagno. Oggi, 25 anni dopo la fondazione di Victoria + Albert, le nostre vasche da bagno e i nostri lavabi, vincitori di numerosi premi, si trovano in alcune delle case e degli hotel più belli del mondo.

Il lusso sta nei dettagli. Dalla manodopera qualificata, ai materiali che compongono i nostri prodotti, fino al costante supporto post vendita per tutti i nostri clienti. Eseguiamo consegne in tutto il mondo, ogni ordine viene rapidamente elaborato ed evaso dai nostri centri di distribuzione. Grazie alla garanzia di 25 anni sui nostri prodotti, scegliere Victoria + Albert significa fare un investimento per la vita.

Victoria + Albert Baths is begonnen uit een passie voor luxe baden.

De visie was simpel: de norm stellen voor stijl, innovatie en prestaties in sanitair. Vandaag, 25 jaar nadat Victoria + Albert werd opgericht, zijn onze baden en wastafels te vinden in 's werelds meest luxueuze huizen en hotels.

De luxe zit hem in het oog voor detail. Van de kwaliteit van het vakmanschap en de materialen die in elk van onze producten verwerkt zijn, tot de ondersteuning door de experts in ons klantenserviceteam. Wij leveren over de hele wereld; elke bestelling wordt snel verzonden vanuit onze internationale distributiecentra. Met de gemoedsrust van een 25-jaar garantie* is uw keuze voor Victoria + Albert een investering voor het leven.



Molly Elizabeth Design and Sean Litchfield photography

* Garantie limitée seulement aux produits en QUARRYCAST™ blancs; excluant la finition de peinture extérieure, les robinetteries, les kits de vidages et la finition des pieds. Cela n'affecte pas les droits des consommateurs établis.

* Die Garantie bezieht sich nur auf weiße QUARRYCAST™ Produkte; ausgenommen sind Farbfinishes, Armaturen, Ab- und Überlaufgarnituren und Beschichtungen von Füßen. Der gesetzliche Anspruch bleibt davon unberührt.

* Garanzia limitata ai soli prodotti QUARRYCAST™ bianchi; escluse vernici, rubinetteria, kit di scarico & placcatura dei piedi. Ciò non pregiudica i diritti legali.

* Garantie beperkt tot witte QUARRYCAST™ producten; exclusief kleuropties, kraanwerk, afvoeren en metaalafwerking van poten. Dit heeft geen invloed op uw wettelijke rechten.

What is QUARRYCAST™?

Qu'est-ce que le QUARRYCAST™?

Le QUARRYCAST™, notre matériau exclusif, est constitué d'un mélange unique de Volcanic Limestone™ et de résines ultra-performantes.

Volcanic Limestone™ est le nom donné par Victoria + Albert à sa pierre blanche très spéciale, parfaite pour concevoir des baignoires et des vasques. Sa création résulte de l'action des forces élémentaires associées au magma liquide sur la pierre à chaux douce et crayeuse qui l'entoure. L'immense chaleur et la pression du magma transforment la pierre environnante en un nouveau matériau composé de fibres incroyablement résistantes.

Nous mélangeons la Volcanic Limestone™ réduite en poudre à des résines de haute qualité afin de lier ces fibres en une matrice complexe en 3D. Le résultat fini est appelé QUARRYCAST™ – un composite de premier ordre qui offre une solidité, une durabilité et une élégance incomparable.

Was ist QUARRYCAST™?

Unser eigens entwickeltes Material besteht aus einer einzigartigen Mischung aus Volcanic Limestone™ und hochwertigen Harzen.

Volcanic Limestone™ ist Victoria + Alberts Bezeichnung für das spezielle weiße Gestein, das sich perfekt für die Herstellung von Wannen und Becken eignet. Es entstand dadurch, dass Urgewalten im Zusammenspiel mit flüssigem Magma auf das umliegende, weiche Kreidekalkgestein einwirkten. Die immense Hitze und der Druck des Magmas verwandelten das Gestein in ein neues Material, das unglaublich harte, innenliegende Verstrebungen besitzt.

Wir mischen den gemahlten Volcanic Limestone™ mit hochwertigen Harzen, um diese Verstrebungen in einem komplexen 3D Muster zu binden. Das fertige Produkt nennen wir QUARRYCAST™ - ein erstklassiges

Stein-Verbundmaterial von unübertroffener Stabilität, Langlebigkeit und Schönheit.

Cos'è QUARRYCAST™?

Il nostro materiale QUARRYCAST™ appositamente sviluppato, è costituito da una miscela unica di pietra calcarea Volcanic Limestone™ e resine ad alte prestazioni.

Volcanic Limestone™ è il nome che Victoria + Albert utilizza per la speciale pietra bianca che è perfetta per la creazione di vasche e lavabi. Si forma quando le forze elementali associate al magma liquido agiscono sul limpido calcare calcareo. L'immenso calore e la pressione del magma trasformano la roccia vicina in un nuovo materiale costituito da fili incredibilmente duri.

Mescoliamo la roccia Volcanic Limestone™ macinata con resine di alta qualità per legare questi fili in una matrice 3D complessa. Il risultato finale è QUARRYCAST™ - un composito di pietra di livello mondiale che offre resistenza, durata e bellezza senza rivali.

Wat is QUARRYCAST™?

Ons speciaal ontwikkelde QUARRYCAST™-materiaal is gemaakt van een unieke mix van Volcanic Limestone™ en hoogwaardige harsen.

Volcanic Limestone™ is Victoria + Albert's naam voor de zeer speciale witte steen die perfect is voor het maken van baden en wasbakken. Het wordt gevormd wanneer de elementaire krachten geassocieerd met vloeibaar magma werken op het omringende zachte, kalkachtige kalksteen. De immense hitte en druk van het magma transformeert de naburige steen in een nieuw materiaal dat bestaat uit ongelooflijk harde strengen.

We mengen gemalen Volcanic Limestone™ met hoogwaardige harsen om deze strengen te binden tot een complexe 3D-matrix. Het resultaat is QUARRYCAST™ - een composiet van wereldklasse, dat een ongeëvenaarde sterkte, duurzaamheid en schoonheid biedt.

What are the benefits of QUARRYCAST™?



- **Facile d'entretien.** La surface blanche naturellement brillante s'entretient avec un simple chiffon.
- **Einfach zu reinigen:** Die natürlich glänzende Oberfläche lässt sich leicht abwischen.
- **Facile da pulire:** la superficie naturalmente lucida è facile da pulire.
- **Eenvoudig schoon te maken:** het van nature glanzende oppervlak is gemakkelijk schoon te vegen.



- **Chaud:** chaud au toucher avec des propriétés d'isolation performantes permettant de garder l'eau du bain chaude plus longtemps.
- **Warm:** angenehm zur Haut mit stark isolierenden Eigenschaften. Ihr Badewasser bleibt länger warm.
- **Caldo:** caldo al tatto con elevate proprietà isolanti, per mantenere più a lungo l'acqua del bagno più calda.
- **Warm:** het voelt warm aan en bezit hoge warmte isolerende eigenschappen, waardoor uw badwater langer warm blijft.



- **Résistant aux éraflures et aux tâches:** la surface naturellement blanche et brillante est incroyablement résistante aux teintures capillaires et aux huiles de bain.
- **Unempfindlich und Flecken abweisend:** die natürlich weiß glänzende Oberfläche ist unglaublich strapazierfähig und resistent gegen Haarfärbemittel und Badeöle.
- **Resistente ai graffi e alle macchie:** la superficie lucida, naturalmente bianca, è incredibilmente durevole e resistente alle tinte e agli oli da bagno.
- **Kras- en vlekbestendig:** het van nature witte, glanzende oppervlak is ongelooflijk duurzaam en bestand tegen haarkleurmiddelen en badoliën.



- **Robuste:** QUARRYCAST™ est entièrement solide - deux fois plus robuste que l'acrylique sans risque de craquelure ni de flexion.
- **Stabil:** QUARRYCAST™ ist ein massiver Werkstoff - mehr als doppelt so hart wie Acryl, kein Knarren oder Verbiegen.
- **Forte:** QUARRYCAST™ è solido fino in fondo - più del doppio rispetto all'acrilico senza scricchiolii o flessioni.
- **Sterk:** QUARRYCAST™ is helemaal solide - meer dan twee keer zo hard als acryl. Bovendien kraakt of buigt het niet.



- **Léger:** étonnamment léger, le poids moyen de nos baignoires est de 72kg.
- **Leichtgewicht:** unsere überraschend leichten Wannen wiegen im Durchschnitt nur 72kg.
- **Leggero:** sorprendentemente leggero, il peso medio delle nostre vasche è di soli 72kg.
- **Lichtgewicht:** verrassend lichtgewicht, het gemiddelde gewicht van onze baden is slechts 72kg.



- **Garanti:** garantie résidentielle de 25 ans, garantie commerciale de 8 ans*.
- **Garantie:** 25 Jahre garantie bei privater Nutzung, 8 Jahre garantie bei gewerblicher Nutzung*.
- **Garanzia:** residenziali 25 anni di garanzia, commerciale 8 anni di garanzia*.
- **Garantie:** 25 Jaar consumentengarantie, 8 jaar commerciële garantie*.



- **Résistant aux UV:** Les baignoires et lavabos peuvent être installés en extérieur, sans compromettre la force des matériaux ou leur couleur.
- **UV-beständig:** Badewannen und Waschbecken können im Freien installiert werden, ohne dass die Materialstärke oder Farbe beeinträchtigt wird.
- **Stabile agli UV:** Vasche e lavabi possono essere installati all'esterno senza compromettere la resistenza del materiale o del colore.
- **UV-stabiel:** Baden en wastafels kunnen buiten worden geïnstalleerd zonder afbreuk te doen aan de sterkte of de kleur van het materiaal.

* Garantie limitée seulement aux produits en QUARRYCAST™ blancs; excluant la finition de peinture extérieure, les robinetteries, les kits de vidages et la finition des pieds. Cela n'affecte pas les droits des consommateurs établis.

* Die Garantie erstreckt sich nur auf weiße QUARRYCAST™ Produkte, ausgenommen sind Farbfinishes, Armaturen, Abflusätze und Beschichtungen von Füßen. Ihr gesetzlicher Anspruch bleibt davon unberührt.

* Garanzia limitata ai soli prodotti QUARRYCAST™ bianchi; escluse vernici, rubinetteria, kit di scarico & placcatura dei piedi. Ciò non pregiudica i diritti legali.

* Garantie beperkt tot witte QUARRYCAST™ producten; exclusief kleuropties, kraanwerk, afvoeren en metaalafwerking van poten. Dit heeft geen invloed op uw wettelijke rechten.

Modern Movements In Colour: Architecturally Inspired Palettes

Colour collaboration
with **Wallpaper***

Les Mouvements Modernes En Couleur : Des Palettes Inspirées Par L'architecture

Les styles architecturaux du 20e siècle ont inspiré la nouvelle collection de palettes de couleurs de Wallpaper* et Victoria + Albert. Inspirée par les palettes de tons des minimalistes belges, les éclaboussures de couleurs primaires du modernisme brésilien et les chromatismes éclatants du postmodernisme américain, la rédactrice en chef Sarah Douglas a adapté et réinventé les nuances et les teintes pour l'environnement contemporain de la salle de bains. Votre périple de découverte de l'architecture moderne de la salle de bains (« bathitecture ») commence ici. Visitez notre site web pour voir l'ensemble de la gamme et visualiser votre design : www.vandabaths.com

Moderne Bewegungen in Farbe: Architektonisch Inspirierte Farbpaletten

Architekturstile des 20. Jahrhunderts inspirierten die neue Farbpaletten-Kollektion von Wallpaper* und Victoria + Albert. Chefredakteurin Sarah Douglas orientierte sich an den Farbpaletten der belgischen Minimalisten, den spritzigen Primärfarben des brasilianischen Modernismus und den knallbunten Farben der amerikanischen Postmoderne, um Schattierungen und Farbtöne für das zeitgenössische Badezimmer zu adaptieren und neu zu interpretieren. Hier beginnt Ihre Reise in die moderne „Bad-Architektur“. Besuchen sie für das gesamte Angebot und die Visualisierung ihrer Designs unsere Website: www.vandabaths.com

Movimenti Moderni A Colori: Palette Di Ispirazione Architettonica

Gli stili architettonici del 20° secolo hanno ispirato la nuova collezione di palette cromatiche di Wallpaper* e Victoria + Albert. La caporedattrice Sarah Douglas ha studiato le gamme tonali impiegate dai minimalisti belgi, gli spruzzi di colori primari del modernismo brasiliano e i cromatismi del postmodernismo americano, adattando e reimmaginando ombre e tinte per l'ambiente bagno contemporaneo. Il vostro viaggio nell'architettura moderna del bagno inizia qui. Per dare un'occhiata all'intera gamma e visualizzare il design più idoneo ti invitiamo a visitare il nostro sito: www.vandabaths.com

Moderne Bewegingen In Kleur: Architectonisch Geïnspireerde Paletten

Architectuurstijlen uit de 20e eeuw vormden de inspiratie voor de nieuwe collectie kleurenpaletten van Wallpaper* en Victoria + Albert. Hoofdredactrice Sarah Douglas keek naar de tonen gebruikt door de Belgische minimalisten, de spatten van primaire kleuren in het Braziliaanse modernisme en de kleurrijke chromatiek in het Amerikaanse postmodernisme. Vervolgens paste ze de kleur en tinten aan voor een nieuwe invulling van de hedendaagse badkameromgeving. Uw reis naar moderne 'badarchitectuur' begint hier. Bezoek onze website om het hele assortiment te bekijken en uw ontwerp te visualiseren: www.vandabaths.com



Belgian Minimalism



Brazilian Modernism



American Postmodernism

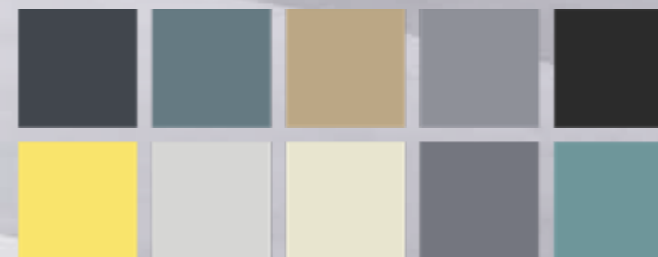

Petite Luxury



Chestnut Residence. Photography by *Bruce Damonte.

Le petit luxe

Les baignoires de luxe ne doivent pas être réservées aux personnes disposant de grandes salles de bains. La beauté et l'élégance d'une baignoire en îlot peuvent mettre en valeur une pièce plus petite, en libérant davantage le sol et en créant une plus grande sensation d'espace. La nouvelle gamme de baignoires de 1500 mm de Victoria + Albert apporte le luxe aux salles de bains les plus compactes. Une alternative élégante à la baignoire encastrée traditionnelle.

Luxus im Kleinen

Luxuriöses Baden sollte nicht nur Inhabern großer Badezimmer vorbehalten sein. Die Schönheit und der Luxus einer freistehenden Badewanne kann auch kleinere Räume aufwerten, indem sie mehr vom Boden freigibt und den Raum optisch vergrößert. Die neuen 1500 mm-Wannen von Victoria + Albert bringen Luxus in die kompaktesten Badezimmer. Eine stilvolle Alternative zu einer konventionellen Einbauwanne.

Il lusso nelle piccole dimensioni

Le vasche da bagno di alto livello non sono destinate solo a bagni di grandi dimensioni. Una vasca da bagno centro stanza, può valorizzare anche un ambiente ridotto, creando un senso di maggiore spazio e arricchendo l'atmosfera. La nuova gamma di vasche da bagno Victoria + Albert da 1500 mm porta il lusso anche nei bagni di piccole dimensioni. Un'alternativa di classe alle solite vasche da incasso.

Luxe in het klein

Genieten van een luxe badervaring is niet langer alleen voor mensen met een grote badkamer. De schoonheid en luxe van een vrijstaand bad kunnen ook de kleinere badkamer verfraaien, door meer van de vloer te laten zien en een groter gevoel van ruimte te creëren. Victoria + Albert heeft een nieuwe serie 1500 mm-baden, die zelfs de meest compacte badkamers luxe brengt. Een stijlvol alternatief voor een conventioneel inbouwbad.

Baignoire / Wanne / Vasca / Bad:

Barcelona 1500, Amiata 1500, Toulouse 1500, Vetralla 1500, ios, Edge, Shropshire, Wessex

Refined designs

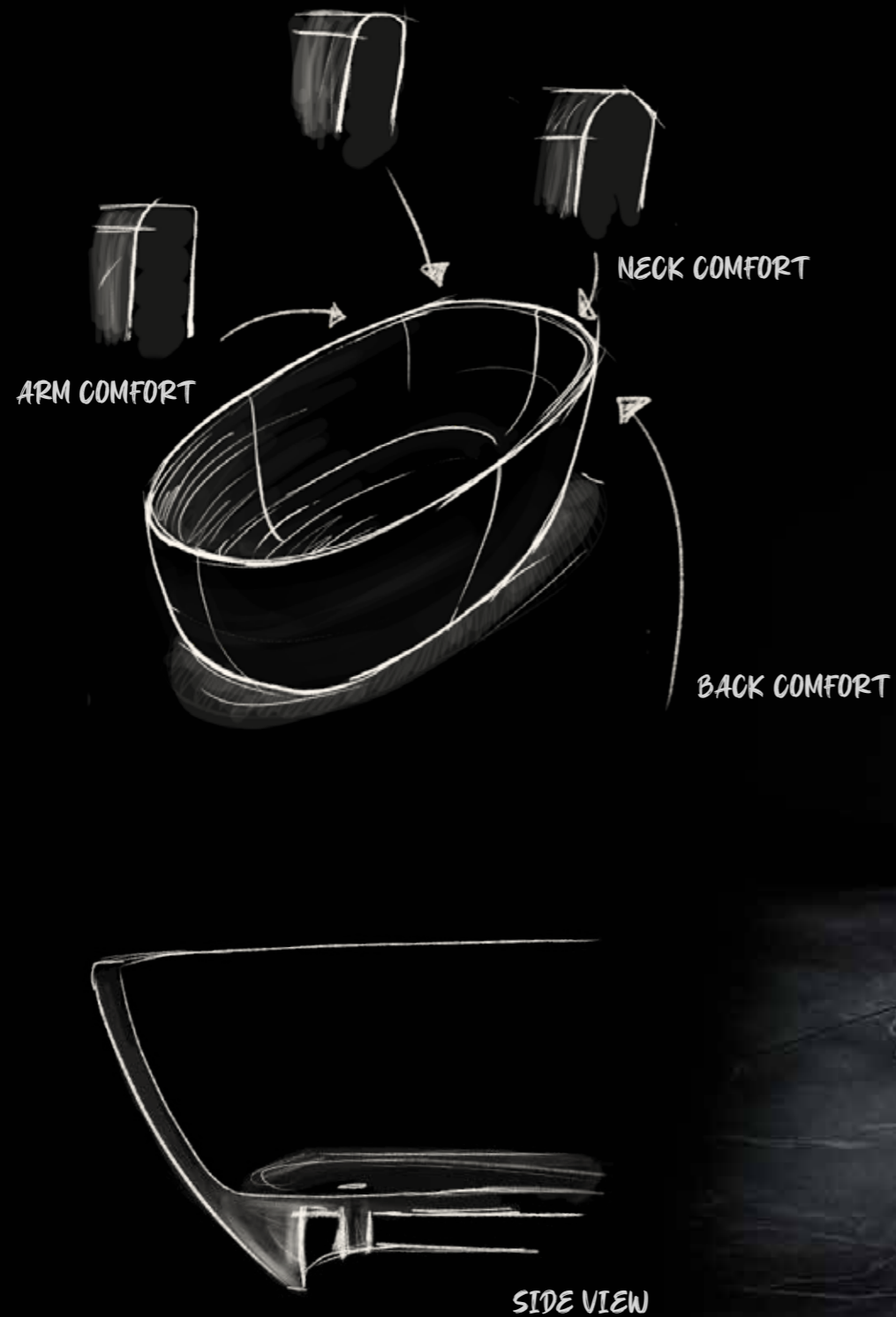

Des designs raffinés

L'équipe de design de Victoria + Albert est réputée pour repousser les limites des conceptions nouvelles et existantes ; elle cherche constamment à améliorer ce que beaucoup considèrent comme la perfection en matière de design.

Leur mission "d'affiner et d'améliorer" est à l'avant-plan de tout ce qu'ils font, de la recherche d'angles plus doux à l'amélioration de l'ergonomie, ils créent des éléments qui non seulement sont beaux mais enrichissent l'expérience du bain.

Explorez nos collections Barcelona et Toulouse pour découvrir ces designs.

Raffinierte Designs

Unser Victoria + Albert Designteam ist bekannt dafür, die Grenzen bei neuen und bestehenden Designs ständig neu auszuloten. Sie versuchen stets, die in den Augen vieler Betrachter perfekten Designs weiter zu verbessern.

Im Vordergrund ihrer Arbeit steht die Mission "Verfeinern und Verbessern". Von der Erkundung weicherer Linien bis zu ergonomischen Verbesserungen kreieren sie Merkmale, die nicht nur schön aussehen, sondern auch das Baderlebnis bereichern.

Entdecken Sie unsere Designs und werfen Sie einen Blick auf unsere Kollektionen Barcelona und Toulouse.

Design raffinato

Il Design Team Victoria + Albert si contraddistingue per il desiderio di spingersi oltre, tra linee classiche e moderne, cercando di migliorarsi in ogni prodotto.

La loro missione è "perfezionare e migliorare": questo è il motto che li guida in tutto ciò che fanno. La ricerca di forme morbide ed ergonomiche creano particolari non solo gradevoli, ma in grado di arricchire la wellness experience.

Esplori le nostre collezioni Barcelona e Toulouse per scoprirne i design.

Verfijnde designs

Het designteam van Victoria + Albert staat bekend om hun grensverleggende benadering van nieuwe en bestaande ontwerpen, en hun voortdurende streven om wat velen zien als perfect design verder te verbeteren.

Bij alles wat ze doen, van zachtere hoeken verkennen tot de ergonomie verbeteren, staat hun missie voorop: verfijnen en verbeteren. Ze stellen alles in het werk om sanitair te creëren dat er niet alleen geweldig uitziet maar ook de badervaring verrijkt.

Bekijk onze collecties Barcelona en Toulouse om de designs te ontdekken.



Une gamme primée de baignoires en îlot qui convient à tous les styles et à toutes les tailles de salles de bains. De petites baignoires à la silhouette rectiligne à celles offrant des volumes plus généreux, il existe une forme et un style adaptés à chacun. Notre matériau QUARRYCAST™ est unique et constitue l'un des leaders du marché depuis plus de 25 ans. Découvrez notre gamme de couleurs RAL en finition brillante ou mate.

Eine preisgekrönte Reihe freistehender Wannen, die in Badezimmer unterschiedlichster Stilrichtungen und Größen passen. Von kompakteren Modellen bis hin zu großzügig bemessenen Rolltop Wannen finden Sie hier Formen und Designs für jeden Anspruch. Unser einmaliges QUARRYCAST™ Verbundmaterial ist Marktführer seit über 25 Jahren. Entdecken Sie unser Angebot an RAL Farben - in glänzender und matter Oberfläche.

La gamma di vasche da bagno centro stanza si adatta ai bagni di tutti gli stili e dimensioni. Da profonde vasche ad immersione compatta a spaziose vasche rolltop, esiste una forma e uno stile adatto per ogni bagno. Il nostro materiale unico QUARRYCAST™ è leader del mercato da oltre 25 anni. Esplori la nostra gamma di colori RAL con finiture lucide e opache.

Een bekrond assortiment aan vrijstaande baden voor badkamers in alle stijlen en afmetingen. We hebben een vorm en stijl voor elke behoefte, van compacte moderne tot ruime klassieke ligbaden. Ons unieke QUARRYCAST™-composiet is al meer dan 25 jaar een marktleider. Ontdek ons spectrum van RAL-kleuren in glanzende of matte afwerkingen.



QUARRYCAST™ Blanc.
QUARRYCAST™ Weiß.
QUARRYCAST™ Bianco.
QUARRYCAST™ Wit.



QUARRYCAST™ Blanc Mat.
QUARRYCAST™ Standard Matt.
QUARRYCAST™ Standard Opaco.
QUARRYCAST™ Standaard Mat.



Personalise.
Personaliser.
Personalifizieren.
Aanpassen.

Pieds / Füße / Piedi / Poten



Chrome Poli.
Chrom Poliert.
Cromo Lucidato.
Chroom Glanzend.



Laiton Poli.
Messing Poliert.
Ottone Lucidato.
Messing Glanzend.



Nickel Poli.
Nickel Poliert.
Nickel Lucidato.
Nickel Glanzend.



Nickel Brossé.
Nickel Gebürstet.
Nickel Spazzolato.
Nickel Geborsteld.



Métal Blanc.
Metall Weiß.
Metallo Bianco.
Wit Metalen.



QUARRYCAST™ Blanc.
QUARRYCAST™ Weiß.
QUARRYCAST™ Bianco.
QUARRYCAST™ Wit.



Vetralla 1500 1493 x 739 Page 142	Edge 1498 x 799 Page 52	Barcelona 1500 1500 x 724 Page 32	Taizu 1500 x 1500 Page 122	ios 1511 x 802 Page 72	Toulouse 1500 1519 x 744 Page 132	Amiata 1500 1519 x 726 Page 26
--	--------------------------------------	--	---	-------------------------------------	--	---

Double-ended	✓	✓	✓	✓	✓	✓
Feet						
Standard Matt	✓		✓	✓	✓	✓



Wessex 1525 x 761 Page 150	Shropshire 1537 x 762 Page 118	Amalfi 1632 x 794 Page 20	Mozzano 1645 x 741 Page 84	Amiata 1650 1645 x 800 Page 28	Trivento 1650 x 707 Page 136	Vetralla 1650 1650 x 727 Page 144
---	---	--	---	---	---	--

Double-ended				✓	✓	✓
Feet	✓	✓				
Standard Matt			✓	✓		✓



Richmond 1675 x 745 Page 110	Mozzano 2 1685 x 759 Page 88	Drayton 1685 x 842 Page 48	Pescadero 1695 x 798 Page 98	Barcelona 1700 1700 x 808 Page 34	ionian 1701 x 793 Page 68	Terrassa 1702 x 793 Page 126
---	---	---	---	--	--	---

Double-ended	✓		✓	✓	✓	✓
Feet	✓		✓			
Standard Matt		✓		✓	✓	



Warndon 1702 x 801 Page 146	Roxburgh 1704 x 809 Page 114	Hampshire 1705 x 776 Page 64	York 1741 x 795 Page 158	Cabrits 1743 x 748 Page 40	Ravello 1743 x 753 Page 106
--	---	---	---------------------------------------	---	--

Double-ended	✓			✓		✓
Feet		✓	✓			
Standard Matt						

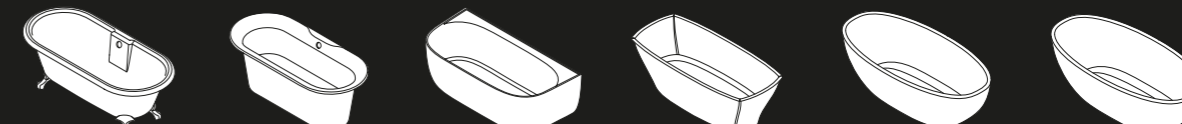

Cheshire 1744 x 798 Page 44	Monaco 1744 x 806 Page 80	Eldon 1749 x 850 Page 56	Pembroke 1765 x 798 Page 94	Barcelona Classic 1785 x 854 Page 38	Barcelona 1800 1800 x 866 Page 36
--	--	---------------------------------------	--	---	--

Double-ended	✓	✓	✓	✓	✓
Feet	✓				
Standard Matt				✓	✓



Worcester 1797 x 780 Page 154	Toulouse 1800 1811 x 808 Page 134	Napoli 1900 x 845 Page 90	Marlborough 1901 x 870 Page 76	Elwick 1902 x 910 Page 60	Radford 1902 x 910 Page 102
--	--	--	---	--	--

Double-ended	✓	✓	✓	✓	✓
Feet					
Standard Matt		✓	✓		✓

Double-ended / Double assise / Doppelseitig / Doppia seduta / Dubbelzijdig.
Feet / Pieds / Füßen / Piedi / Poten.
Standard Matt / Blanc Mat / Standard Opaco / Standaard Mat.



Baths with void spaces

Vide sanitaire

Pour faciliter l'installation de la tuyauterie d'évacuation et créer une esthétique homogène, un certain nombre de nos baignoires en îlot sont conçues avec un vide sanitaire. L'espace supplémentaire sous la baignoire réduit la nécessité de casser le sol. Conçu pour fonctionner avec nos vidages intelligents, Kit 36 et Kit 40, le vide sanitaire est disponible sur une large gamme de baignoires de notre collection.

Hohlräume

Um die Abfluss-Installation zu erleichtern und eine nahtlose Ästhetik zu ermöglichen, sind einige unserer freistehenden Badewannen mit einem Hohlraum ausgestattet. Der zusätzliche Raum unter der eigentlichen Wanne verringert die Notwendigkeit, solide Böden aufbrechen zu müssen. Die mit unseren Kit 36 und Kit 40 Intellidrains kompatiblen Hohlräume sind für zahlreiche unserer Badewannen quer durch das Sortiment erhältlich.

Spazi vuoti

Per facilitare l'installazione di tubi di scarico e creare un'estetica senza interruzioni, molte delle nostre vasche centro stanza sono state progettate con un vano tecnico nella parte inferiore. Lo spazio sotto la vasca riduce l'intervento sul pavimento sottostante. Ideato per funzionare insieme ai nostri kit 36 e 40 Intellidrain, lo spazio vuoto è disponibile in molte delle vasche da bagno presenti sul nostro catalogo.

Dubbele bodems

Om de installatie van afvoerleidingen te vergemakkelijken en een naadloze esthetiek te creëren, zijn een aantal van onze vrijstaande baden ontworpen met een dubbele bodem. De extra ruimte onder de badkuip vermindert de noodzaak om vloeren open te breken. De lege ruimte is ontworpen om gebruikt te worden in combinatie met onze Kit 36 en Kit 40 Intellidrains, en is beschikbaar voor een groot aantal baden in ons portfolio.

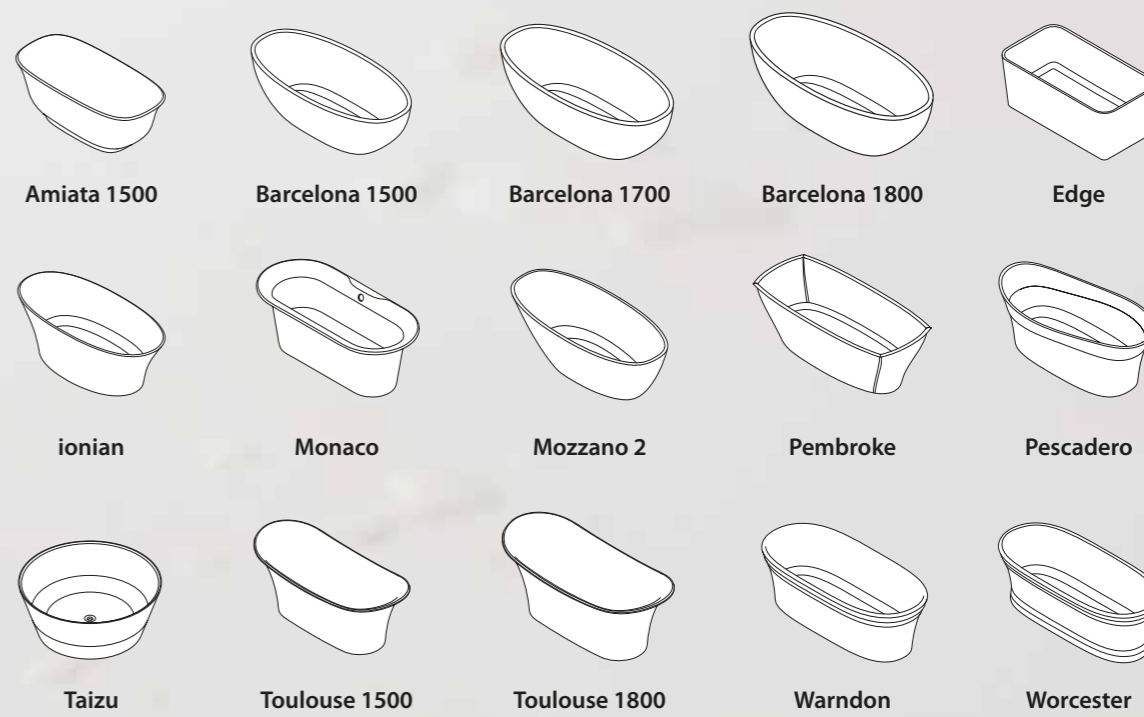
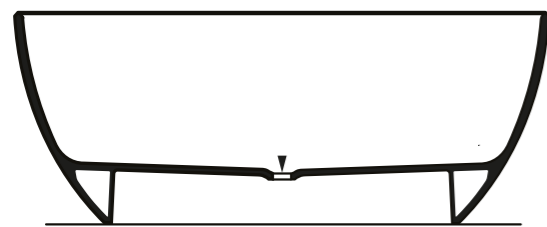

Ses courbes adoucies tombent élégamment sur le sol sans être encombrées par de la tuyauterie. Son dossier allongé vous permet de vous relaxer à tête reposée, ce qui est absolument essentiel lors de longues ablutions. Accompagnée par la vasque Amalfi 55 (page 172). Découvrez notre gamme de couleurs RAL en finition mate ou brillante.

Weich konturierte Seite bis zum Boden, Rohre des Ablaufes ordentlich versteckt und eine erweiterte Rückenlehne welche eine volle Unterstützung des Kopfes bietet; wesentlich für das lange luxuriöse Baden. Mit dem Amalfi 55 Waschbecken zu ergänzen (seite 172). Schauen Sie sich das Spektrum der verfügbaren RAL-Farben in glänzender und matter Oberfläche an.

Progettata con linee semplici, che allo stesso tempo rendono invisibile il sistema di scarico; un comodo schienale fornisce un estensivo supporto per la nuca, essenziale per godere una lunga e lussuosa vasca. Complementato dal lavabo Amalfi 55 (pagina 172). Esplori la nostra gamma di colori RAL con finiture lucide e opache.

Zacht ronde zijden, een netjes afgewerkte overloop en een langere rugleuning bieden volledige ondersteuning van het hoofd; van essentieel belang voor diegene die van lang luxueus baden houdt. Aangevuld met de Amalfi 55 wasbak (pg 172). Ontdek ons spectrum van RAL-kleuren in glanzende of matte afwerkingen.

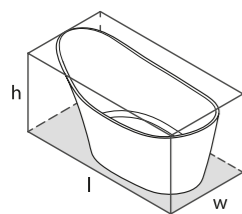

l = 1632mm/64¼"
w = 794mm/31¼"
h = 859mm/33¾"

- AML-N-SW-NO
 - Ⓜ AMLM-N-SM-NO
 - PAINT-BATH
- 70kg



Collections connexes / Entsprechendes Zubehör / Collezioni correlate / Gerelateerde collecties



Amalfi 55
Page 172



○ AML-N-SW-NO   AMLM-N-SM-NO 

  Massachusetts Code
cUPC listing by IAPMO

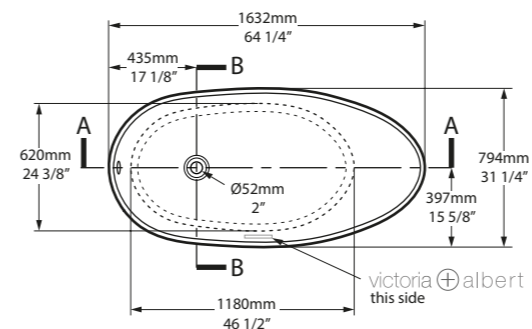

Top View

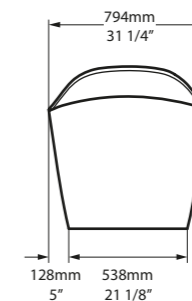

Front View

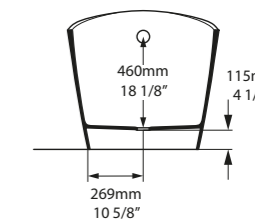

Section BB

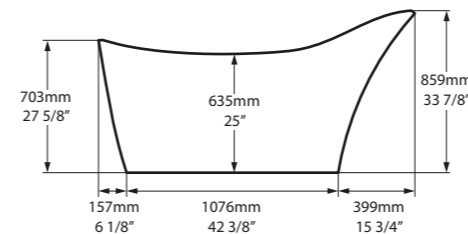

Side View

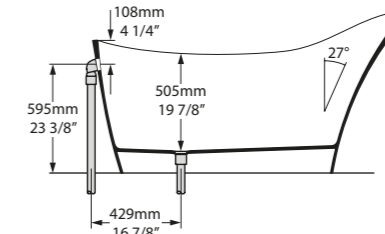

Section AA

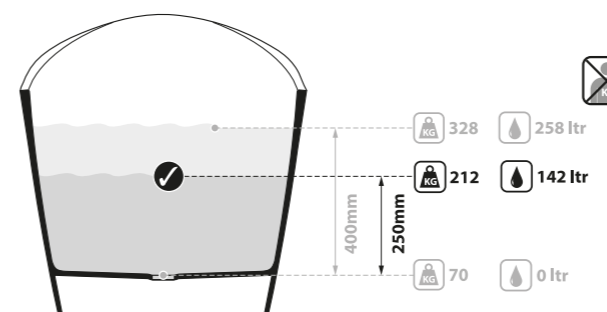

Manhattan, New York, USA

Photography by: Marili Forastieri

Design by: Tara Benet Design



SW QUARRYCAST™ Blanc.
QUARRYCAST™ Weiß.
QUARRYCAST™ Bianco.
QUARRYCAST™ Wit.

SM QUARRYCAST™ Blanc Mat.
QUARRYCAST™ Standard Matt.
QUARRYCAST™ Standard Opaco.
QUARRYCAST™ Standaard Mat.

 rich in
Volcanic
Limestone



Personalise.
Personaliser.
Personalifizieren.
Aanpassen.



reddot award 2015
winner

MENEGHELLO PAOLELLI ASSOCIATI

La collection primée Amiata a été conçue par Meneghello Paoletti Associati. Cette collection, aux courbes organiques et aux proportions élégantes, offre un style et une ergonomie classiques. Amiata s'intègre parfaitement aux espaces traditionnels et modernes. L'Amiata est désormais disponible en deux tailles, offrant ainsi des solutions design pour les salles de bains compactes. En complément du lavabo Amiata 60 (page 174). Découvrez notre gamme de couleurs RAL en finition mate ou brillante.

Die preisgekrönte Amiata Kollektion wurde von Meneghello Paoletti Associati entworfen. Mit ihren organischen Kurven und eleganten Proportionen bietet diese Kollektion klassischen Stil und Ergonomie. Die Amiata fügt sich sowohl in traditionelle als auch in moderne Räume ein. Das Modell ist jetzt in zwei Größen erhältlich und bietet auch eine Design-Lösung für kompakte Badezimmer. Dazu passt das Waschbecken Amiata 60 (Seite 174). Schauen Sie sich das Spektrum der verfügbaren RAL-Farben in glänzender und matter Oberfläche an.

La collezione Amiata è stata progettata da Meneghello Paoletti Associati. Questa collezione, con curve morbide e proporzioni eleganti offre uno stile classico, ma ergonomico al tempo stesso. Amiata si sposa perfettamente sia con gli spazi tradizionali sia a moderni. Amiata è ora disponibile in due misure, offrendo soluzioni di design per bagni di dimensioni ridotte. la serie si completa con il lavabo Amiata 60 (pagina 174). Esplori la nostra gamma di colori RAL con finiture lucide e opache.

De bekroonde Amiata-collectie is ontworpen door Meneghello Paoletti Associati. Deze collectie, met haar organische rondingen en elegante proporties, biedt een klassieke stijl en ergonomie. Amiata werkt perfect in zowel traditionele als moderne ruimtes. De Amiata is nu verkrijgbaar in twee maten, wat ontwerp oplossingen biedt voor compacte badkamers. Aangevuld met de Amiata 60 wastafel (pag. 174). Ontdek ons spectrum van RAL-kleuren in glanzende of matte afwerkingen.

Amiata collection 

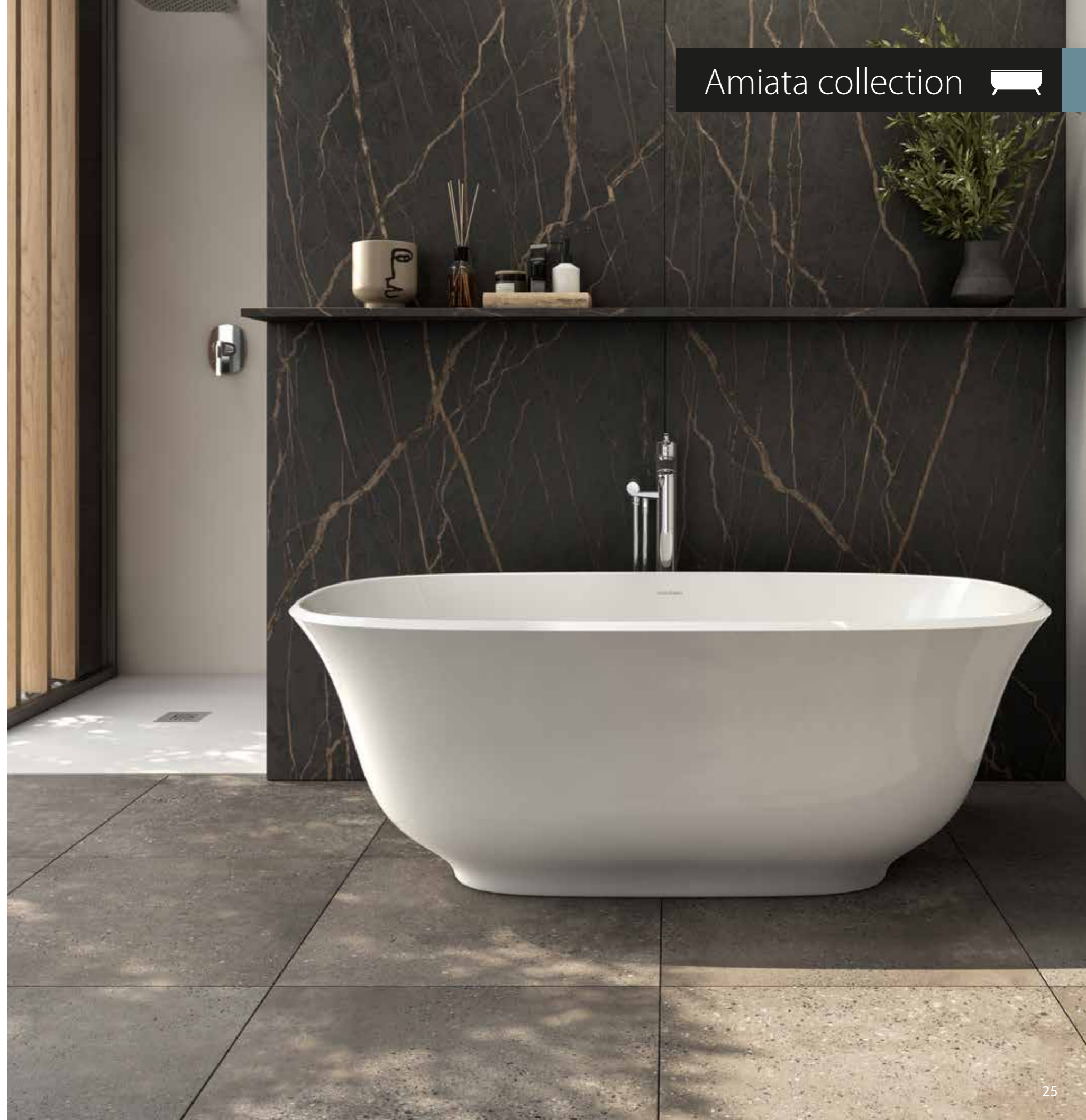



Amiata 1500

○ AMT1-N-SW-NO  ○ AMT1M-N-SM-NO 



Massachusetts Code: Pending
cUPC listing by IAPMO: Pending

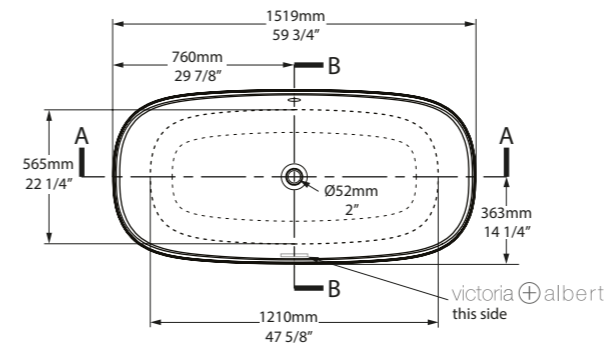

Top View

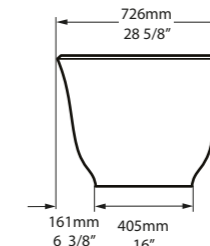

Front View

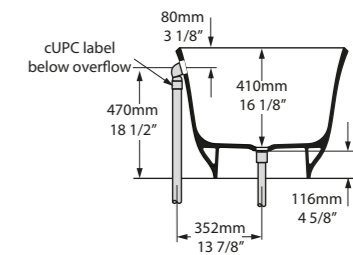

Section BB

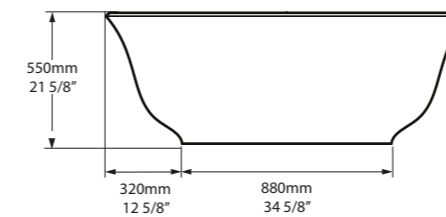

Side View

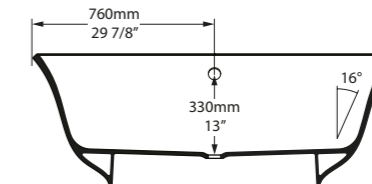

Section AA

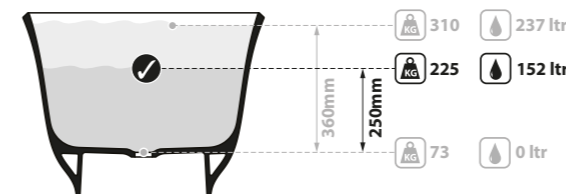

L'Amiata 1500 reprend le design iconique de l'Amiata 1650, mais dans un format plus compact. Elle offre aussi un vide sanitaire dans sa partie inférieure pour les tuyaux d'évacuation. Découvrez notre gamme de couleurs RAL en finition mate ou brillante.

De Amiata 1500 volgt hetzelfde iconische ontwerp als de Amiata 1650, maar in een compacter formaat. Voorzien van een dubbele bodem voor afvoerleidingen. Ontdek ons spectrum van RAL-kleuren in glanzende of matte afwerkingen.

Als Neuzugang im Programm bietet die Amiata 1500 dasselbe ikonische Design wie die Amiata 1650 auf einer kompakteren Stellfläche. Ein Hohlraum unterhalb der Wanne verbirgt die Abflussinstallation. Schauen Sie sich das Spektrum der verfügbaren RAL-Farben in glänzender und matter Oberfläche an.

La Amiata 1500 segue lo stesso iconico design dell'Amiata 1650, ma con un'anima più compatta. La vasca vanta inoltre un vano tecnico nella parte inferiore per i tubi di scarico. Esplori la nostra gamma di colori RAL con finiture lucide e opache.

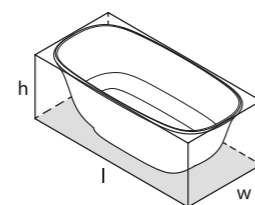

l = 1519mm/59 3/4"
w = 726mm/28 5/8"
h = 550mm/21 5/8"

○ AMT1-N-SW-NO
○ AMT1M-N-SM-NO
PAINT-BATH
73kg



QUARRYCAST™ Blanc.
QUARRYCAST™ Weiß.
QUARRYCAST™ Bianco.
QUARRYCAST™ Wit.



QUARRYCAST™ Blanc Mat.
QUARRYCAST™ Standard Matt.
QUARRYCAST™ Standard Opaco.
QUARRYCAST™ Standaard Mat.



Personalise.
Personaliser.
Personalifizieren.
Aanpassen.



○ AMT-N-SW-NO  ○ AMTM-N-SM-NO 

  Massachusetts Code
cUPC listing by IAPMO
Registered Design

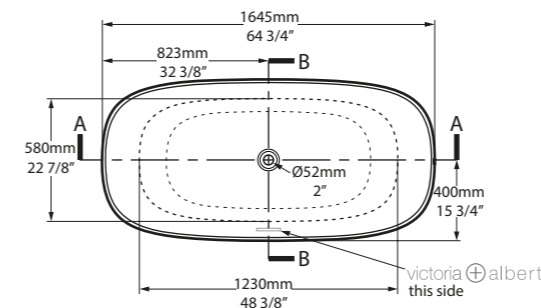

Top View

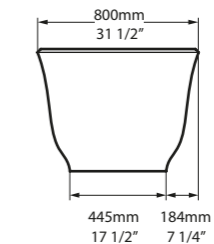

Front View

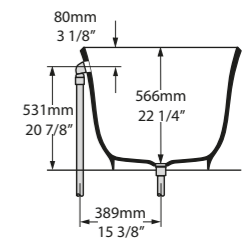

Section BB

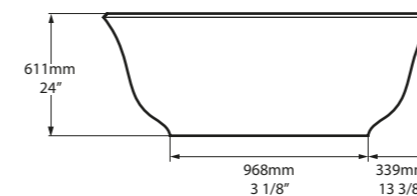

Side View

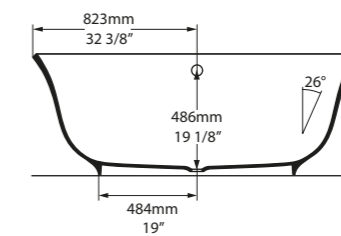

Section AA

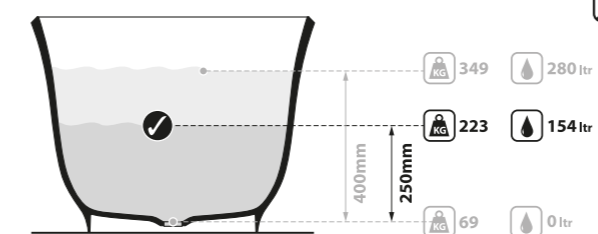

Le modèle primé Amiata 1650 crée un design élégant dans les salles de bains modernes ou traditionnelles. Elle est complétée par la vasque Amiata 60 (page 174). Découvrez notre gamme de couleurs RAL en finition mate ou brillante.

Die preisgekrönte Amiata 1650 ist ein elegantes Design-Statement in modernen und traditionellen Badezimmern. Dazu passt das Waschbecken Amiata 60 (Seite 174). Schauen Sie sich das Spektrum der verfügbaren RAL-Farben in glänzender und matter Oberfläche an.

La pluripremiata Amiata 1650 regala un tocco di design in tutti i vostri bagni, sia classici che moderni. Si completa con il lavabo Amiata 60 (pagina 174). Esplori la nostra gamma di colori RAL con finiture lucide e opache.

De bekroonde Amiata 1650 creëert een elegant designstatement in moderne of traditionele badkamers. Aangevuld met de Amiata 60 wastafel (pag. 174). Ontdek ons spectrum van RAL-kleuren in glanzende of matte afwerkingen.

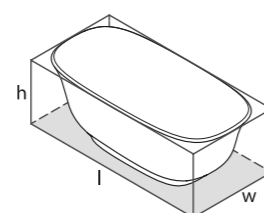

l = 1645mm/64 3/4"
w = 800mm/31 1/2"
h = 611mm/24"

○ AMT-N-SW-NO
○ AMTM-N-SM-NO
PAINT-BATH
69kg

SW QUARRYCAST™ Blanc.
QUARRYCAST™ Weiß.
QUARRYCAST™ Bianco.
QUARRYCAST™ Wit.

SM QUARRYCAST™ Blanc Mat.
QUARRYCAST™ Standard Mat.
QUARRYCAST™ Standard Opaco.
QUARRYCAST™ Standaard Mat.

 rich in
Volcanic
Limestone

  Personalise.
Personaliser.
Personalisieren.
Aanpassen.

Une icône du design réinventée.

Victoria + Albert a le plaisir de vous présenter une collection Barcelona réinventée, avec une meilleure ergonomie et un rebord intelligemment chanfreiné pour plus de confort au niveau des bras et du cou. Grâce à une taille adaptable et une gamme coordonnée de lavabos, la collection Barcelona est désormais accessible aux salles de bains modernes de toute taille.

Ein überarbeitetes Kult-Design.

Victoria + Albert präsentieren eine überarbeitete Barcelona Kollektion mit verbesserter Ergonomie und intelligent abgeschrägtem Rand für zusätzlichen Nacken- und Armkomfort. Dank modularer Größen und einem abgestimmten Waschbecken-Sortiment lässt sich die Barcelona Kollektion jetzt an moderne Badezimmer aller Größen anpassen.

Un'icona di design reinventata.

Victoria + Albert è lieta di presentare la collezione Barcelona riprogettata, ora con ergonomia migliorata e bordi sapientemente smussati che garantiscono la comodità di collo e braccia. Dimensioni modulari e una gamma coordinata di lavabi rende la collezione Barcelona ideale per i bagni moderni di tutte le dimensioni.

Een designicoon herleeft.

Victoria + Albert introduceert met genoeg een vernieuwde Barcelona-collectie, nu met verbeterde ergonomie en een intelligent afgeronde badrand om comfort te bieden voor nek en armen. Modulaire maatvoeringen en een bijpassend assortiment wastafels maken de Barcelona-collectie nu toegankelijk voor moderne badkamers van elke afmeting.

Collections connexes / Entsprechendes Zubehör / Collezioni correlate / Gerelateerde collecties

Barcelona 1500



○ BA1-N-SW-NO  ○ BA1M-N-SM-NO 

  Massachusetts Code: Pending
cUPC listing by IAPMO: Pending

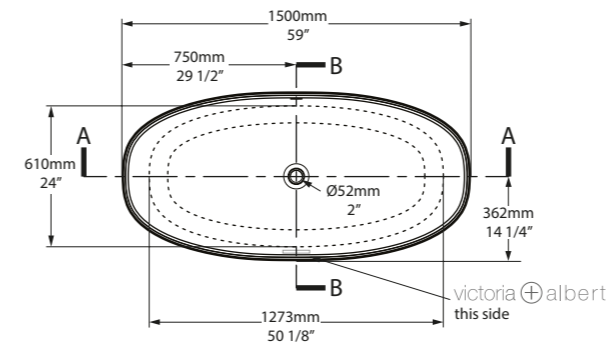

Top View

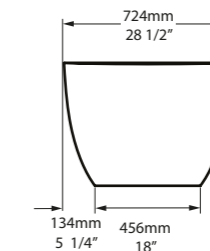

Front View

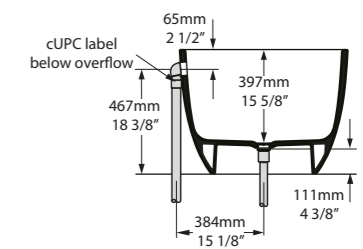

Section BB

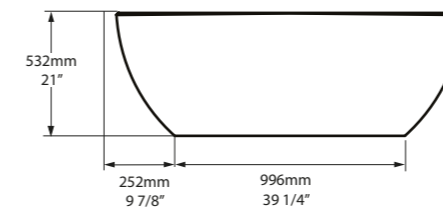

Side View

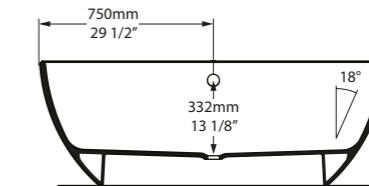

Section AA

La Barcelona 1500 est l'incarnation du design moderne adapté aux petites salles de bains. Son design épuré, en forme de galet, offre un rebord chanfreiné pour plus de confort au niveau des bras et du cou, ainsi qu'un vide sanitaire sous la baignoire pour les tuyaux d'évacuation. Découvrez notre gamme de couleurs RAL en finition mate ou brillante.

Neu im Programm ist die Barcelona 1500, ein modernes Design-Statement für das kleinere Badezimmer. Das sanft geschwungene, kieselförmige Design bietet mit abgeschrägten Rändern zusätzlichen Nacken- und Armkomfort und ist mit einem Hohlraum für die Unterbringung der Abflussinstallation ausgestattet. Schauen Sie sich das Spektrum der verfügbaren RAL-Farben in glänzender und matter Oberfläche an.

La Barcelona 1500 vanta un design moderno ideale per i bagni di piccole dimensioni. È levigata, dalla forma a ciottolo con il bordo smussato che garantisce comodità di collo e braccia, e un vano

tecnico nella parte inferiore per i tubi di scarico. Esplori la nostra gamma di colori RAL con finiture lucide e opache.

De Barcelona 1500 is een modern designstatement voor de kleinere badkamer. Het gladde, kiezelvormige design heeft een afgeronde badrand voor comfort in de nek en armen, en een dubbele bodem voor afvoerleidingen. Ontdek ons spectrum van RAL-kleuren in glanzende of matte afwerkingen.

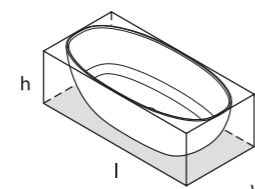

l = 1500mm/59"
w = 724mm/28 1/2"
h = 532mm/21"

○ BA1-N-SW-NO
○ BA1M-N-SM-NO
PAINT-BATH
80kg

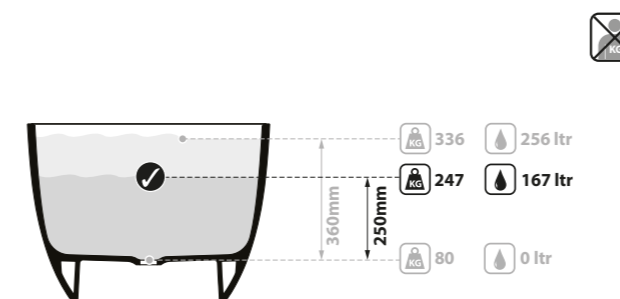

SW QUARRYCAST™ Blanc.
QUARRYCAST™ Weiß.
QUARRYCAST™ Bianco.
QUARRYCAST™ Wit.

SM QUARRYCAST™ Blanc Mat.
QUARRYCAST™ Standard Matt.
QUARRYCAST™ Standard Opaco.
QUARRYCAST™ Standaard Mat.

 rich in
Volcanic
Limestone



Personalise.
Personaliser.
Personalisieren.
Aanpassen.



Barcelona 1700

○ BA2-N-SW-NO  ○ BA2M-N-SM-NO 

CE  Massachusetts Code
cUPC listing by IAPMO

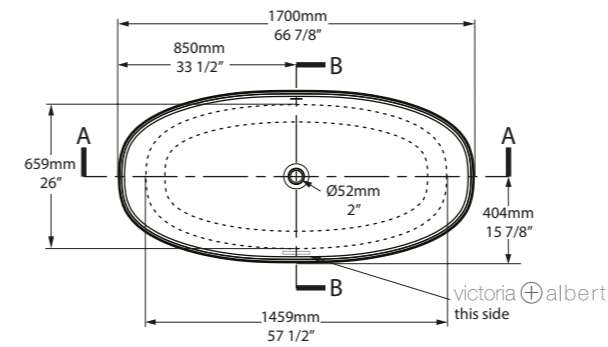

Top View

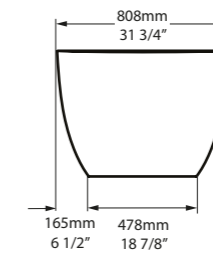

Front View

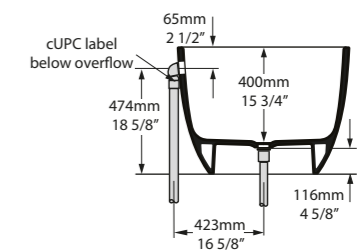

Section BB

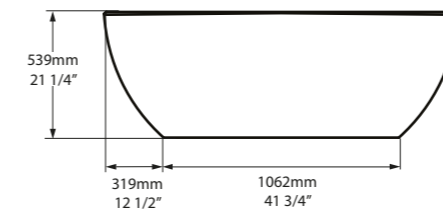

Side View

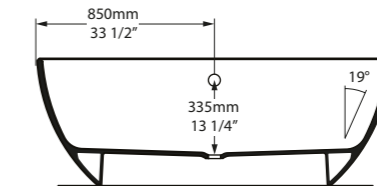

Section AA

Barcelona 1700 est conçue pour la salle de bains moderne. Avec une longueur de 1700 mm, elle est parfaitement adaptée aux suites parentales et aux salles de bains familiales. Anciennement appelée Barcelona 2, Barcelona 1700 offre désormais un rebord chanfreiné pour plus de confort au niveau du cou et des bras, un meilleur soutien au niveau du bas du dos, et un vide sanitaire sous la baignoire pour les tuyaux d'évacuation. Découvrez notre gamme de couleurs RAL en finition mate ou brillante.

Die Barcelona 1700 ist für das moderne Badezimmer konzipiert. Mit einer Länge von 1700 mm ist die Wanne perfekt für Master Suites oder Familien-Badezimmer geeignet. Die frühere Barcelona 2 ist als Barcelona 1700 mit abgeschrägtem Rand für zusätzlichen Nacken- und Armkomfort, einer verbesserten Lendenwirbelunterstützung und einem Hohlraum unterhalb der Wanne ausgestattet, der die Abflussinstallation verbirgt. Schauen Sie sich das Spektrum der verfügbaren RAL-Farben in glänzender und matter Oberfläche an.

La Barcelona 1700 è progettata per il bagno moderno. Con una lunghezza di 1700 mm è ideale per le suite padronali o bagni familiari. Precedentemente nota come "Barcelona 2", ora la Barcelona 1700 vanta un bordo smussato per la comodità di testa e collo,

supporto lombare migliorato, e un vano tecnico nella parte inferiore per i tubi di scarico. Esplori la nostra gamma di colori RAL con finiture lucide e opache.

Barcelona 1700 is ontworpen voor de moderne badkamer. Met zijn lengte van 1700 mm is het perfect geschikt voor master suites of gezinsbadkamers. De Barcelona 1700, voorheen onder de naam Barcelona 2, heeft nu een afgeronde badrand voor hoofd- en nekcomfort, een verbeterde ondersteuning van de onderrug en een dubbele bodem voor afvoerleidingen. Ontdek ons spectrum van RAL-kleuren in glanzende of matte afwerkingen.

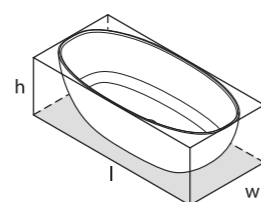

l = 1700mm/66 7/8"
w = 808mm/31 3/4"
h = 539mm/21 1/4"

○ BA2-N-SW-NO
○ BA2M-N-SM-NO
PAINT-BATH
87kg

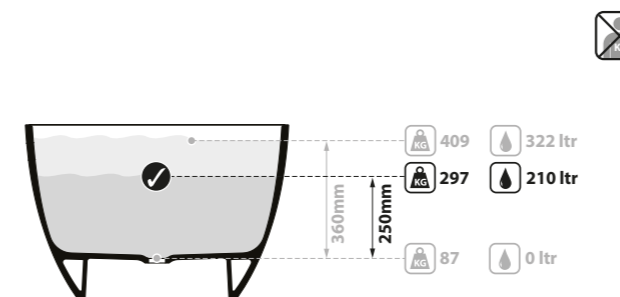

SW QUARRYCAST™ Blanc.
QUARRYCAST™ Weiß.
QUARRYCAST™ Bianco.
QUARRYCAST™ Wit.

SM QUARRYCAST™ Blanc Mat.
QUARRYCAST™ Standard Matt.
QUARRYCAST™ Standard Opaco.
QUARRYCAST™ Standaard Mat.

QC rich in Volcanic Limestone

Personalise.
Personaliser.
Personalifizieren.
Aanpassen.

Barcelona 1800



○ BA3-N-SW-NO  ● BA3M-N-SM-NO 

  Massachusetts Code
cUPC listing by IAPMO

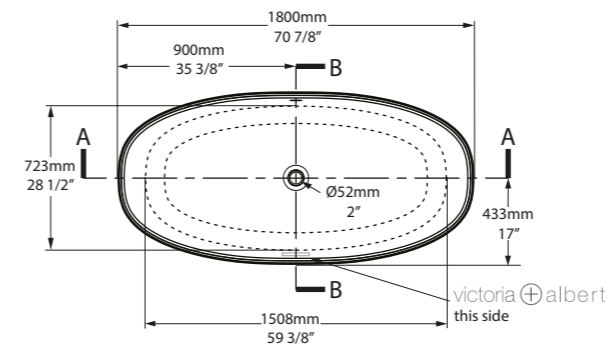

Top View

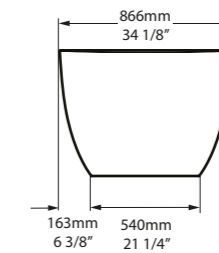

Front View

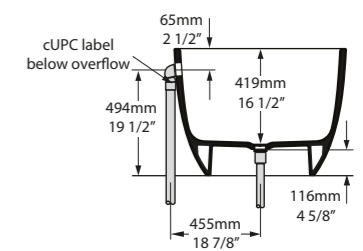

Section BB

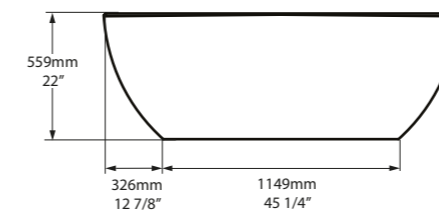

Side View

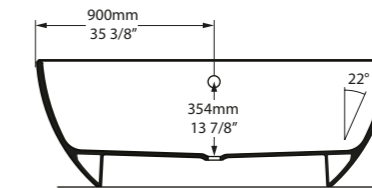

Section AA

Barcelona 1800 est un bijou de design, idéalement adapté à une salle de bains plus grande. Anciennement appelée Barcelona 3, Barcelona 1800 offre désormais un rebord chanfreiné pour plus de confort au niveau du cou et des bras, un meilleur soutien au niveau du bas du dos, et un vide sanitaire sous la baignoire pour les tuyaux d'évacuation. Découvrez notre gamme de couleurs RAL en finition mate ou brillante.

Die Barcelona 1800 ist das ideale Design-Statement für größere Badezimmer. Die frühere Barcelona 3 ist als Barcelona 1800 mit abgeschrägtem Rand für zusätzlichen Nacken- und Armkomfort, einer verbesserten Lendenwirbelunterstützung und einem Hohlraum unterhalb der Wanne ausgestattet, der die Abflussinstallation verbirgt. Schauen Sie sich das Spektrum der verfügbaren RAL-Farben in glänzender und matter Oberfläche an.

La Barcelona 1800 è un'affermazione del design, pensata appositamente per bagni di grandi dimensioni. Precedentemente nota come "Barcelona 3", ora la Barcelona 1800 vanta un bordo smussato per la comodità di testa e collo, supporto lombare

migliorato, e un vano tecnico nella parte inferiore per i tubi di scarico. Esplori la nostra gamma di colori RAL con finiture lucide e opache.

Barcelona 1800 is een designstatement, bij uitstek geschikt voor een grotere badkamer. De Barcelona 1800, voorheen onder de naam Barcelona 3, heeft nu een afgeronde badrand voor hoofd- en nekcomfort, een verbeterde ondersteuning van de onderrug en een lege ruimte aan de onderkant voor afvoerleidingen. Ontdek ons spectrum van RAL-kleuren in glanzende of matte afwerkingen.

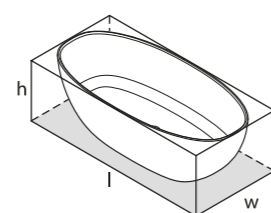

l = 1800mm/70 7/8"
w = 866mm/34 1/8"
h = 559mm/22"

○ BA3-N-SW-NO
● BA3M-N-SM-NO
PAINT-BATH
95kg

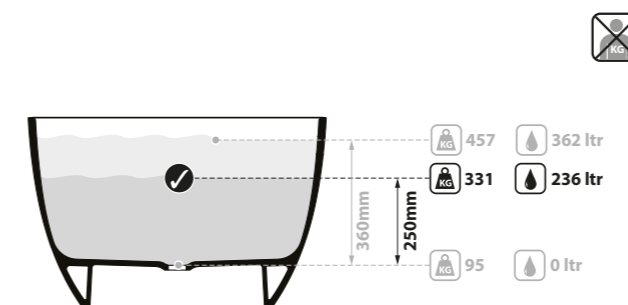

SW QUARRYCAST™ Blanc.
QUARRYCAST™ Weiß.
QUARRYCAST™ Bianco.
QUARRYCAST™ Wit.

SM QUARRYCAST™ Blanc Mat.
QUARRYCAST™ Standard Matt.
QUARRYCAST™ Standard Opaco.
QUARRYCAST™ Standaard Mat.

 rich in
Volcanic
Limestone

 Personalise.
Personaliser.
Personalifizieren.
Aanpassen.



Elizabeth Kruger Designs

Barcelona Classic

○ BAR-N-SW-NO ☒ ○ BARM-N-SM-NO ☒

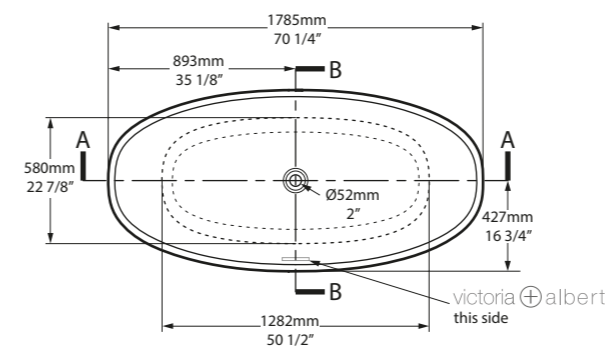

Top View

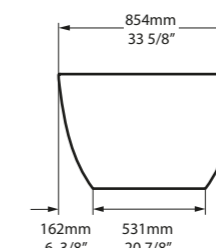

Front View

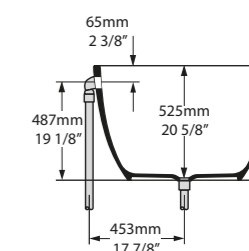

Section BB

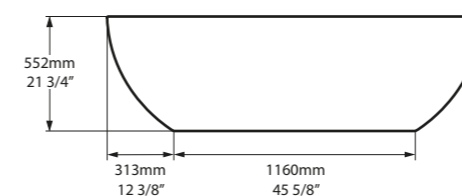

Side View

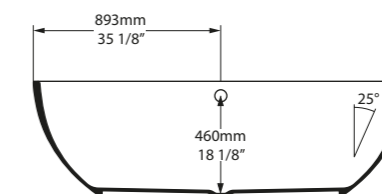

Section AA

Inspirée par le design organique de la célèbre ville, la Barcelona Classic offre des courbes opulentes ; parfaite pour les amoureux des baignoires de luxe. La Barcelona Classic n'a pas de vide sanitaire. Découvrez notre gamme de couleurs RAL en finition mate ou brillante.

Das organische Design der Barcelona Classic mit seinen opulenten Kurven ist durch die Stadt inspiriert - perfekt für alle, die eine Leidenschaft für luxuriöses Baden hegen. Die Barcelona Classic hat keinen Hohlraum unterhalb der Wanne. Schauen Sie sich das Spektrum der verfügbaren RAL-Farben in glänzender und matter Oberfläche an.

Ispirata dalla città famosa per il suo design organico, la Barcelona Classic vanta curve opulente, perfetta per gli appassionati di bagni lussuosi. La Barcelona Classic non ha il vano tecnico nella parte inferiore della vasca. Esplori la nostra gamma di colori RAL con finiture lucide e opache.

De Barcelona Classic, geïnspireerd door de stad die beroemd is om haar organische design, is voorzien van weelderige rondingen - perfect voor iedereen die een passie heeft voor luxe baden. De Barcelona Classic heeft geen dubbele bodem. Ontdek ons spectrum van RAL-kleuren in glanzende of matte afwerkingen.

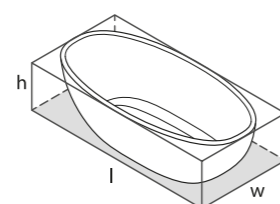

l = 1785mm/70 1/4"
w = 854mm/33 5/8"
h = 552mm/21 3/4"

○ BAR-N-SW-NO
○ BARM-N-SM-NO
PAINT-BATH
93kg

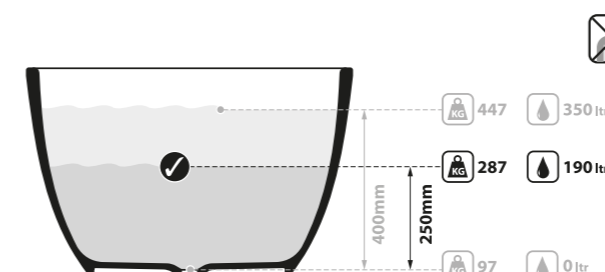

SW QUARRYCAST™ Blanc.
QUARRYCAST™ Weiß.
QUARRYCAST™ Bianco.
QUARRYCAST™ Wit.

SM QUARRYCAST™ Blanc Mat.
QUARRYCAST™ Standard Matt.
QUARRYCAST™ Standard Opaco.
QUARRYCAST™ Standaard Mat.



Personalise.
Personaliser.
Personalifizieren.
Aanpassen.



Avec ses lignes épousant les courbes du corps, Cabrits s'adapte à chacun. Sa forme unique avec un bassin de chaque côté en fait l'une des baignoires les plus confortables qui soit et, de plus, sa capacité de seulement 176 litres fait d'elle l'une des plus économes en eau de toute la gamme Victoria + Albert. A associer à la vasque Cabrits 55 (page 182). Découvrez notre gamme de couleurs RAL en finition mate ou brillante.

Mit Kurven, die sich geradezu an den Körper anschmiegen, bietet die Cabrits Wanne herausragenden Komfort für Badeliebhaber unterschiedlichster Körpergröße. Das originelle "Tandem" Design macht sie zu einer der bequemsten und komfortabelsten Wannen überhaupt. Gleichzeitig ist sie dank ihres maximalen Wasservolumens von gerade einmal 176 Litern die wassereffizienteste Wanne im Victoria + Albert Produktsortiment. Zu kombinieren mit dem Becken Cabrits 55 (Seite 182). Schauen Sie sich das Spektrum der verfügbaren RAL-Farben in glänzender und matter Oberfläche an.

Sagomata per adattarsi alla persona, la vasca Cabrits offre un supporto ideale ad ogni tipo di corpo. Il suo design speciale "double dip", ovvero a "doppia caduta", la rende una delle vasche più confortevoli sul mercato e, con una capacità massima di soli 176 litri, anche la miglior vasca "salva acqua" della collezione Victoria + Albert. Complementata dal lavabo di design Cabrits 55 (pagina 182). Esplori la nostra gamma di colori RAL con finiture lucide e opache.

De Cabrits biedt een uiterst comfortabele en perfecte ondersteuning aan het gehele lichaam, voor zowel mensen met een groot als ook een kleiner postuur. Het speciale 'double dip' ontwerp verhoogt het comfort van het bad en is met maximaal 176 Liter tegelijkertijd ook het meest waterbesparende bad uit de collectie van Victoria + Albert. Aangevuld met de Cabrits 55 wasbak (pg 182). Ontdek ons spectrum van RAL-kleuren in glanzende of matte afwerkingen.

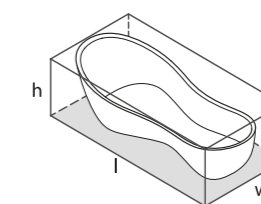

l = 1743mm/68 5/8"
w = 748mm/29 1/2"
h = 564mm/22 1/4"

○ CAB-N-SW-NO
■ PAINT-BATH
66kg

Collections connexes / Entsprechendes Zubehör / Collezioni correlate / Gerelateerde collecties

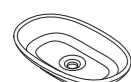

Cabrits 55
Page 182



○ CAB-N-SW-NO 



 Massachusetts Code
cUPC listing by IAPMO
Registered Design

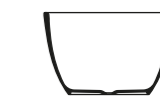
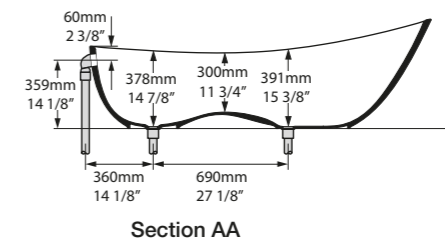
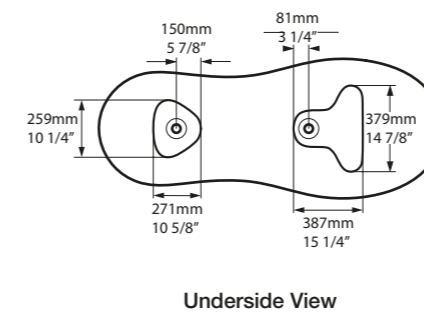
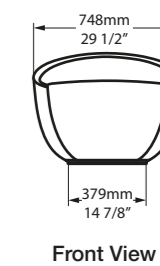
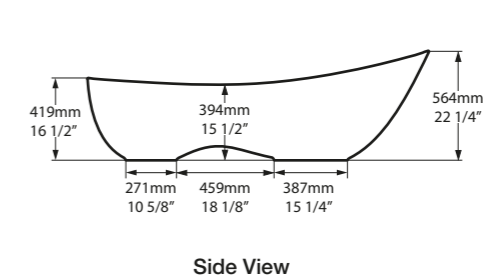
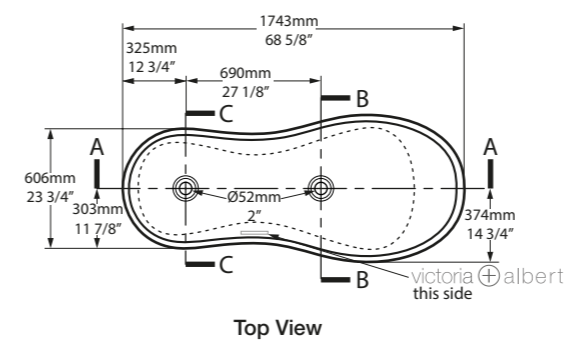

Section BB



Section CC

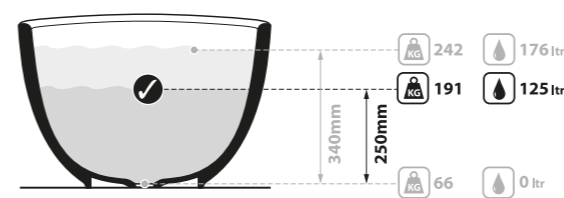

Austin, Texas, USA

Photography by: Casey Dunn

Design by: Alterstudio Architecture



QUARRYCAST™ Blanc.
QUARRYCAST™ Weiß.
QUARRYCAST™ Bianco.
QUARRYCAST™ Wit.



rich in
Volcanic
Limestone



Personalise.
Personaliser.
Personalisieren.
Aanpassen.



Un classique éternel : la baignoire à double assise de style Victorien offre en option une gamme de pieds "griffes" déclinée en plusieurs finitions. Découvrez notre gamme de couleurs RAL en finition mate ou brillante. Une gamme de finitions pour pieds en métal est disponible - voir page suivante.

Der zeitlose Klassiker - eine tiefe Wanne im viktorianischen Stil mit einer Auswahl unterschiedlicher Ball- und Klauenfüße. Schauen Sie sich das Spektrum der verfügbaren RAL-Farben in glänzender und matter Oberfläche an. Eine Auflistung der verfügbaren Metalloberflächen für die Füße finden Sie auf der nächsten Seite.

Un classico senza tempo - un'ampia vasca Vittoriana a doppio schienale di proporzioni generose che offre una vasta gamma di piedi favolosi formati da artigli appoggiati su sfere. Esplori la nostra gamma di colori RAL con finiture lucide e opache. E' disponibile una gamma di finiture per piedini in metallo - vedi nella pagina seguente.

De tijdloze klassieker - een diep Victoriaans dubbelzijdige Roll-Top bad met verschillende Ball & Claw poot opties. Ontdek ons spectrum van RAL-kleuren in glanzende of matte afwerkingen. Een gamma van afwerkingen van metaal poten zijn beschikbaar (zie volgende blz).

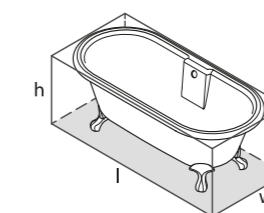

l = 1744mm/68⁵/₈"
w = 798mm/31³/₈"
h = 646mm/25³/₈"

○ CHE-N-SW-OF
👤 PAINT-BATH
61kg

Collections connexes / Entsprechendes Zubehör / Collezioni correlate / Gerelateerde collecties

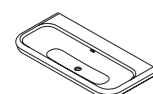

Lario 100 Solo
Page 214



○ CHE-N-SW-OF

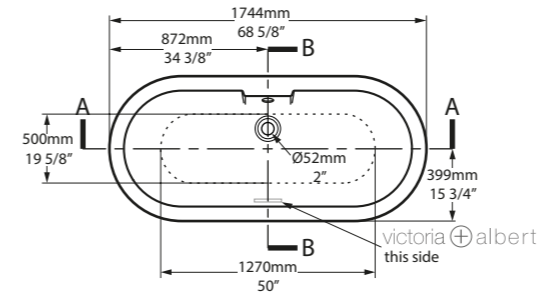

Top View

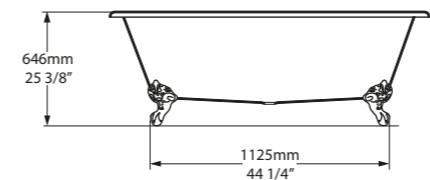

Side View

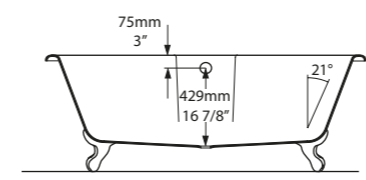

Section AA

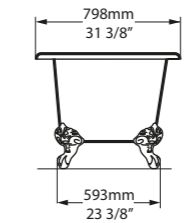

Front View

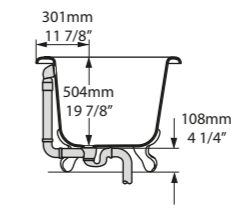

Section BB

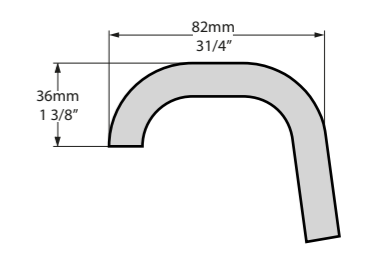
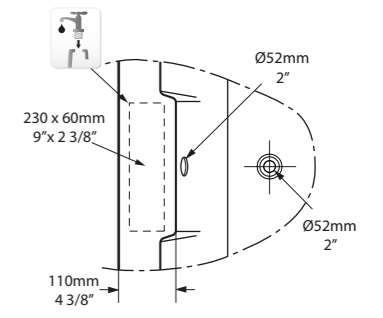

Rim Detail

CE Massachusetts Code CUPC listing by IAPMO

Tap holes can be drilled by installer
 Armaturenlöcher können leicht vom Installateur gebohrt werden
 Les trous de robinetterie peuvent être percés par l'installateur
 Pueden ser perforados por el instalador
 I fori per rubinetti possono essere perforati dall'installatore

Sorrento, Victoria, Australia

Photography by: Armelle Habib

Design by: D + D Home



rich in Volcanic Limestone™

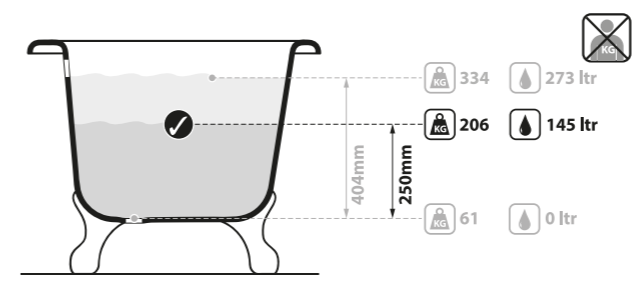

SW

QUARRYCAST™ Blanc.
 QUARRYCAST™ Weiß.
 QUARRYCAST™ Bianco.
 QUARRYCAST™ Wit.

rich in Volcanic Limestone™



Personalise.
 Personaliser.
 Personaliziere.
 Aanpassen.



S'inspirant de la forme de la traditionnelle baignoire sabot victorienne et intégrant des détails contemporains élégants, la baignoire Drayton offre un soutien des épaules pour une expérience de bain optimale. Elle est complétée par la vasque Drayton 40 (page 184). Découvrez notre gamme de couleurs RAL en finition mate ou brillante.

Die Drayton Wanne entspricht in ihrer Form der original viktorianischen Slipperwanne - plus moderner Opulenz und wunderschönen Randdetails. Die großzügigen Abmessungen der Drayton und die bequeme Schulterpositionierung garantieren ein außergewöhnliches Baderlebnis. Zu kombinieren mit dem Drayton 40 Waschbecken (Seite 184). Schauen Sie sich das Spektrum der verfügbaren RAL-Farben in glänzender und matter Oberfläche an.

Prendendo la sua forma dalla vasca Vittoriana originale, ma con l'aggiunta di un'abbondanza dei giorni nostri, la vasca Drayton offre un supporto per le spalle per godere al massimo un'esperienza sublime. Complementata dal lavabo Drayton 40 (pagina 184). Esplori la nostra gamma di colori RAL con finiture lucide e opache.

Uitgaande van het originele Victoriaanse slipper bad vorm met toevoeging van modern comfort en mooie rand detaillering, biedt de Drayton met zijn royale afmetingen en schouder-ondersteuning een sublieme badervaring. Aangevuld met de Drayton 40 wasbak (pg 184). Ontdek ons spectrum van RAL-kleuren in glanzende of matte afwerkingen.

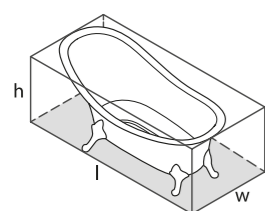

l = 1685mm/66³/₈"
w = 842mm/33³/₈"
h = 850mm/33¹/₂"

○ DRA-N-SW-OF
■ PAINT-BATH
63kg

Collections connexes / Entsprechendes Zubehör / Collezioni correlate / Gerelateerde collecties



Candella 100
Page 228



Anatolia 55
Page 240



○ DRA-N-SW-OF 

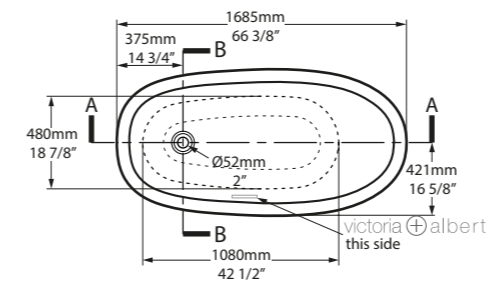

Top View

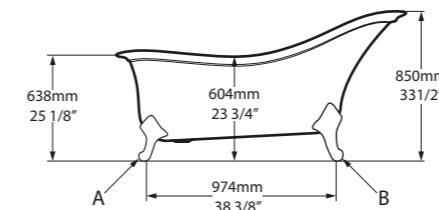

Side View

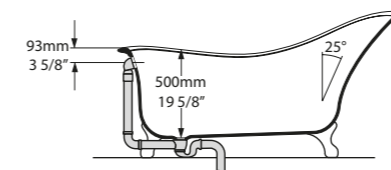

Section AA



Front View

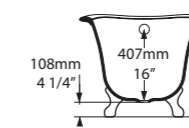

Section BB

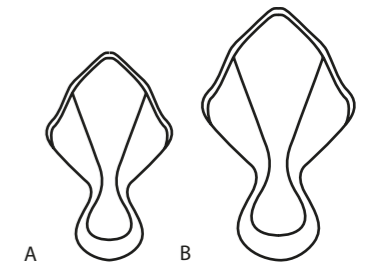

A

B

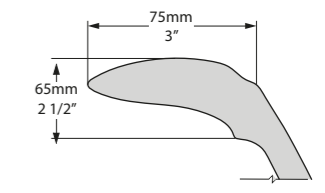

Rim Detail

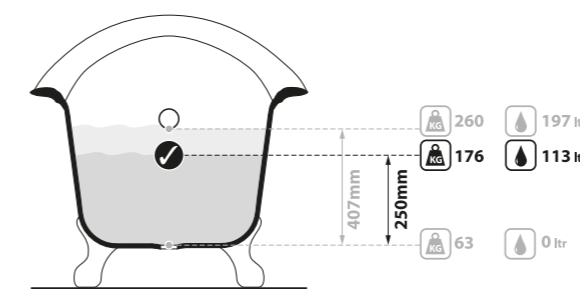

Gorgeous George, Cape Town, South Africa

Photography by: Frances Marais, Design Hotels™

Design by: Tristan Plessis Studio



rich in Volcanic Limestone™



QUARRYCAST™ Blanc.
QUARRYCAST™ Weiß.
QUARRYCAST™ Bianco.
QUARRYCAST™ Wit.

rich in Volcanic Limestone™



Personalise.
Personaliser.
Personalifizieren.
Aanpassen.

Profondeur généreuse et double assise luxueuse dans un format compact. Le modèle Edge possède la plupart des qualités de la baignoire ios, le style cubique en plus. Edge dispose d'un vide sanitaire en-dessous pour le système d'évacuation. Accompagnée par la vasque Edge 45 (page 186). Découvrez notre gamme de couleurs RAL en finition mate ou brillante.

Tiefe, doppelseitige Luxuswanne mit kompaktem Format. Edge teilt viele Vorzüge der ios, bietet aber als Extra einen markanten, kubischen Stil und einen unten liegenden Hohlraum für die Abflussrohre. Zu kombinieren mit dem Edge 45 Waschbecken (Seite 186). Schauen Sie sich das Spektrum der verfügbaren RAL-Farben in glänzender und matter Oberfläche an.

Con doppio schienale, profonda ed elegante in un formato compatto. La vasca Edge condivide molte delle qualità della vincente ios, con l'aggiunta dello distintivo stile cubico. Complementato dal lavabo Edge 45 (pagina 186). Esplori la nostra gamma di colori RAL con finiture lucide e opache.

Diepe, dubbelzijdige luxe in een compacte vormgeving. De Edge heeft veel gemeen met de ios, met een gedistingeerde rechthoekige styling en dubbele bodem voor eenvoudige sifon installatie. Aangevuld met de Edge 45 wasbak (pg 186). Ontdek ons spectrum van RAL-kleuren in glanzende of matte afwerkingen.

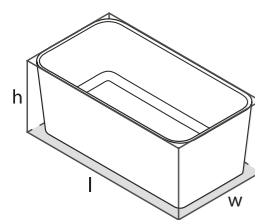

l = 1498mm/59"
w = 799mm/31½"
h = 600mm/23¾"

○ EDG-N-SW-NO
■ PAINT-BATH
95kg

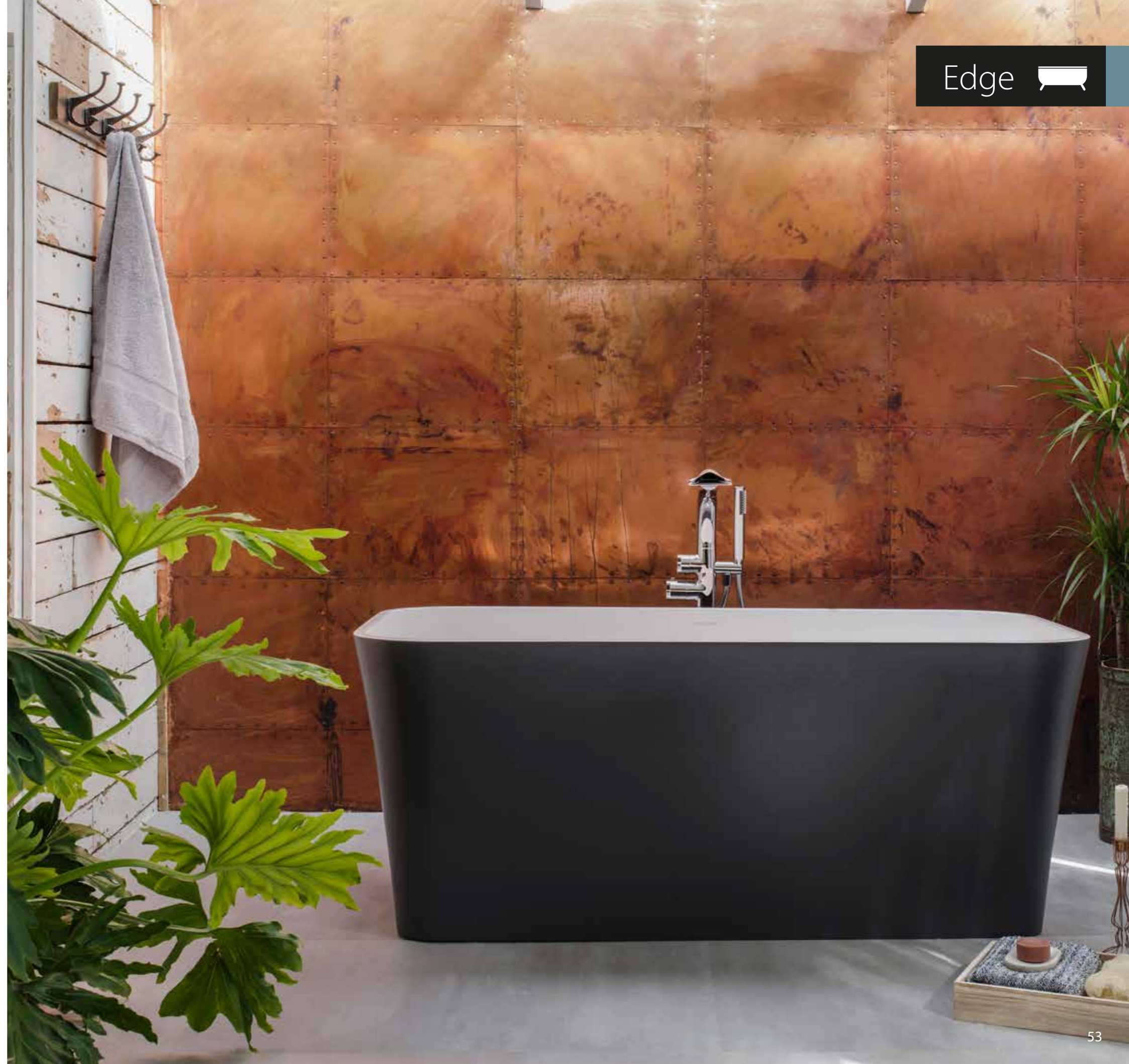



○ EDG-N-SW-NO 

CE  Massachusetts Code cUPC listing by IAPMO

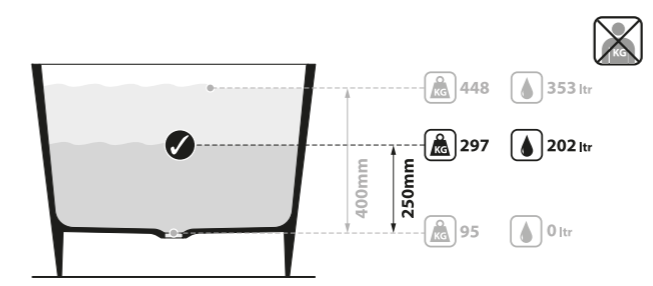
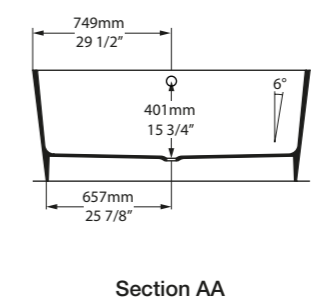
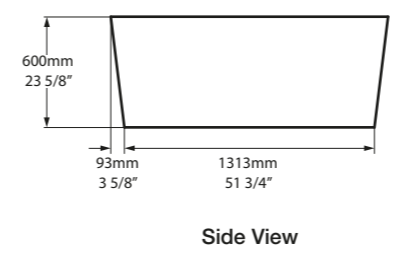
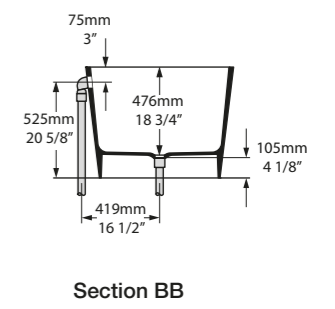
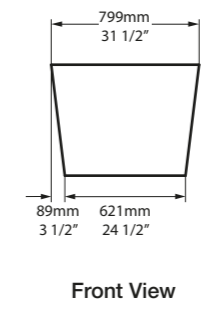
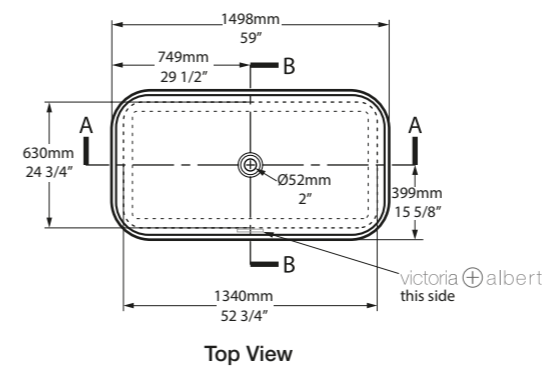

Atlanta, Georgia, USA

Photography by: Emily Followill

Design by: Wyeth Ray Interiors



SW

QUARRYCAST™ Blanc.
QUARRYCAST™ Weiß.
QUARRYCAST™ Bianco.
QUARRYCAST™ Wit.

rich in
Volcanic
Limestone



Personalise.
Personaliser.
Personalizierien.
Aanpassen.



CONRAN+ PARTNERS

Eldon est la création de Conran + Partners, un cabinet d'architecture et de design intérieur britannique de renom, qui a appliqué son expertise acquise lors de la conception de quelques-uns des plus grands hôtels et résidences du monde.

La baignoire murale contemporaine est dotée de lignes généreuses propres aux baignoires en îlot. Les robinets peuvent être installés sur la large surface plane et un rebord moulé permet d'installer aisément le carrelage. Dispose d'un vide sanitaire en-dessous pour le système d'évacuation.

Avec ses 1750mm de long, c'est la baignoire parfaite pour les salles de bains spacieuses ou petites, dans lesquelles les lignes épurées et la praticité sont tout aussi importantes. Découvrez notre gamme de couleurs RAL en finition mate ou brillante.

Die Eldon Wanne ist eine Kreation des führenden britischen Designstudios Conran + Partners, das all seine Erfahrungen in das Projekt einfließen ließ, die es bei der Gestaltung einiger weltweiter Top Hotels und Resorts gesammelt hat.

Die moderne Back-to-Wall Wanne besitzt die üppigen Ausmaße einer freistehenden Wanne. Die Armaturen können auf dem breiten Sockel montiert werden, und die gegossene Aufkantung ermöglicht das leichte Anbringen von Kacheln. Mit einem unten liegenden Hohlraum für die Abflussrohre.

Mit einer Länge von 1750mm ist sie die perfekte Wanne für große oder kleine Badezimmer, in denen klare Linien und hohe Funktionalität gewünscht sind. Schauen Sie sich das Spektrum der verfügbaren RAL-Farben in glänzender und matter Oberfläche an.

Eldon e' la creazione dello studio Leader britannico British Architecture and Interior Design Studio, Conran + Partners, che hanno applicato la loro competenza attraverso la progettazione di alcuni dei migliori hotel e residence di tutto il mondo.

La vasca contemporanea a muro e' dotata di linee curve come una vasca freestanding. Il rubinetto a pavimento nasconde tutto il tubo di scarico ed un'alazatina sagomata permette di installare le piastrelle facilmente.

Con una lunghezza di 1750mm, e' la vasca perfetta per stanze da bagno piccole e grandi, dove le linee pulite e la pulizia di ogni giorno sono importanti in ugual modo. Esplori la nostra gamma di colori RAL con finiture lucide e opache.

Eldon is ontworpen door één van de meest vooraanstaande Britse Architectuur en Interior Design Studios, Conran + Partners, die hun expertise in het ontwerpen van een aantal van 's werelds beste hotels en woningen, hier op hebben toegepast.

Het moderne bad dat tegen de muur geplaatst wordt, wordt gekenmerkt door de ronde lijnen van een vrijstaand bad. Een badkraan kan op de badrand geïnstalleerd worden en de gegoten opstaande rand biedt eenvoudige betegeling. De dubbele bodem zorgt verder voor eenvoudige afvoer installatie.

Met zijn 1750mm lengte, is het een perfecte bad voor zowel grote als kleinere badkamers, waar strakke lijnen en de dagelijkse bruikbaarheid even belangrijk zijn. Ontdek ons spectrum van RAL-kleuren in glanzende of matte afwerkingen.

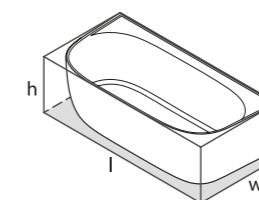

l = 1749mm/68 7/8"
w = 850mm/33 1/2"
h = 600mm/23 5/8"

○ ELD-N-SW-NO
○ ELD-N-SW-OF
⚡ PAINT-BATH
109kg





Essex, United Kingdom

Photography by: Daniela Exley for Amazing Productions

Architecture: Chris Dyson Architects

Design by: Edwina Boase



- ELD-N-SW-NO 
- ELD-N-SW-OF 



 Tap holes can be drilled by installer
 Armaturenlöcher können leicht vom Installateur gebohrt werden
 Les trous de robinetterie peuvent être percés par l'installateur
 Pueden ser perforados por el instalador
 I fori per rubinetti possono essere perforati dall'installatore

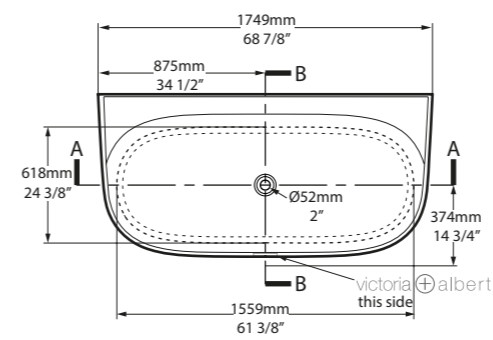

Top View

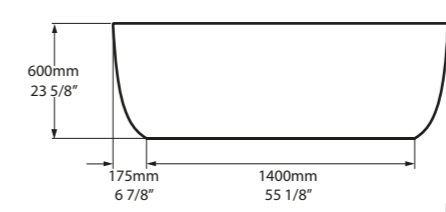

Front View

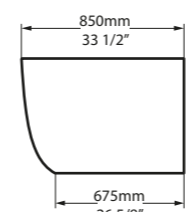
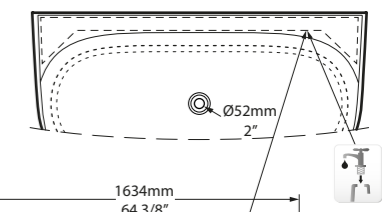

Side View

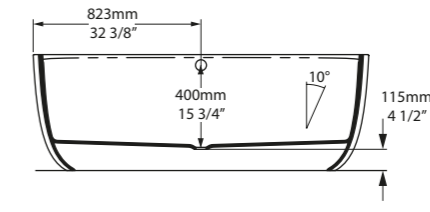

Section AA

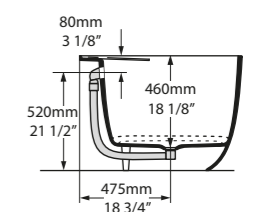

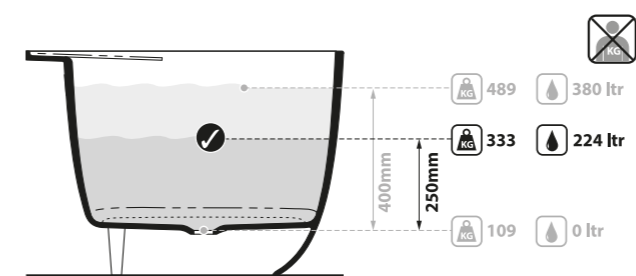

Section BB



SW
 QUARRYCAST™ Blanc.
 QUARRYCAST™ Weiß.
 QUARRYCAST™ Bianco.
 QUARRYCAST™ Wit.



 Personalise.
 Personnaliser.
 Personalisieren.
 Aanpassen.

Elwick est une généreuse baignoire à double assise montée sur un socle afin de dissimuler le système d'évacuation. Les détails subtils font rentrer la forme traditionnelle dans la période moderne. A associer à la vasque Radford 51 (page 196). Découvrez notre gamme de couleurs RAL en finition mate ou brillante.

Die Elwick ist eine großzügig bemessene Double-End Wanne, montiert auf einem Sockel, der die Abflussrohre verbirgt. Schlichte Randverzierungen verbinden die klassische Form mit modernem Anspruch. Zu kombinieren mit dem Radford 51 Waschbecken (Seite 196). Schauen Sie sich das Spektrum der verfügbaren RAL-Farben in glänzender und matter Oberfläche an.

La vasca freestanding Elwick con bordo dettagliato, vanta una forma generosa a doppia seduta, ed e' montata su una base di piedistallo per nascondere lo scarico. Accompagnata dal lavabo Radford 51 (pagina 196). Esplori la nostra gamma di colori RAL con finiture lucide e opache.

Het model Elwick is een ruime dubbelzijdig bad op een sokkel zodat leidingen verborgen blijven. Subtiële rand detaillering, zorgt voor een traditionele vorm in het hedendaagse. Aangevuld met de Radford 51 wasbak (pg 196). Ontdek ons spectrum van RAL-kleuren in glanzende of matte afwerkingen.

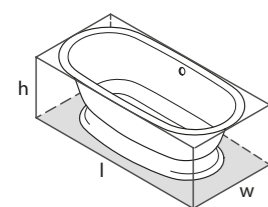

l = 1902mm/74 7/8"
w = 910mm/35 7/8"
h = 622mm/24 1/2"

○ RAD-N-SW-OF + ELW-B-SW
PAINT-BATH
95kg

Collections connexes / Entsprechendes Zubehör / Collezioni correlate / Gerelateerde collecties

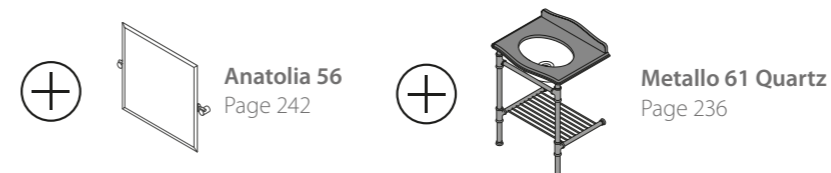



Sydney, New South Wales, Australia

Photography by: Maree Homer

Design by: Denai Kulcsar Interiors



○ RAD-N-SW-OF + ELW-B-SW

CE  Massachusetts Code cUPC listing by IAPMO Registered Design

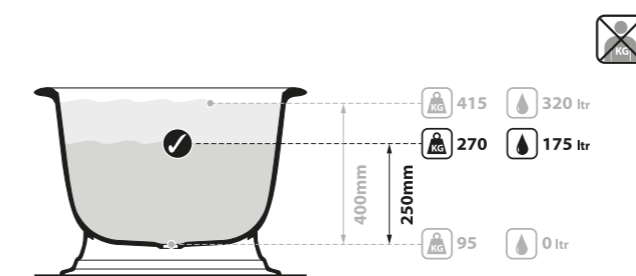
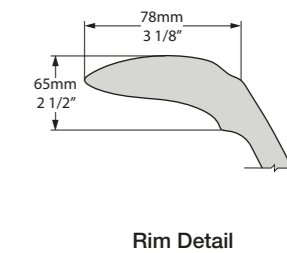
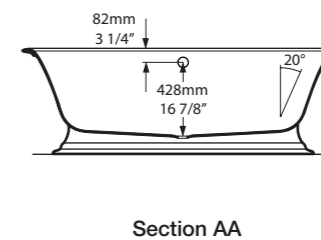
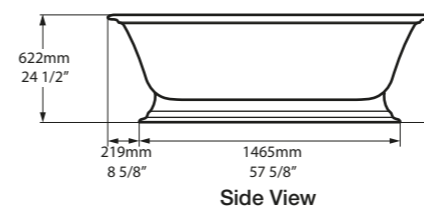
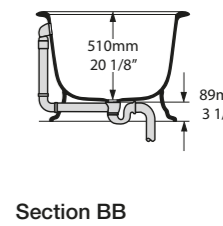
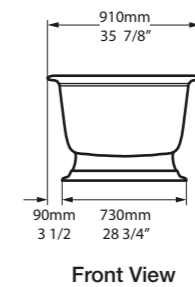
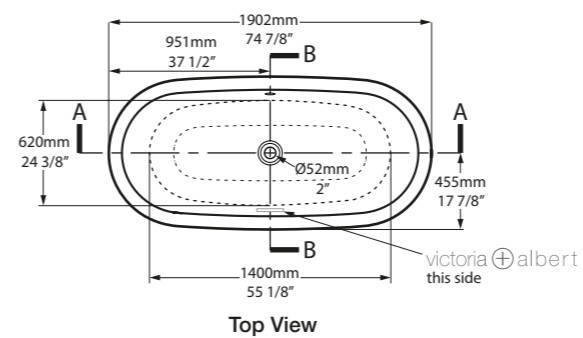

SW QUARRYCAST™ Blanc.
QUARRYCAST™ Weiß.
QUARRYCAST™ Bianco.
QUARRYCAST™ Wit.

QC rich in Volcanic Limestone



Personalise.
Personaliser.
Personalifizieren.
Aanpassen.

Hampshire est une baignoire classique de style Edwardien à un seul dossier relevé pour une immersion profonde. Découvrez notre gamme de couleurs RAL en finition mate ou brillante. Les pieds en métal sont disponibles en différentes finitions - voir page suivante.

Hampshire ist eine klassische Roll-Top Wanne im Stil der Edwardischen Epoche. Durch ihren perfekten Liegewinkel bietet sie ein besonders tiefes Eintaucherlebnis. Schauen Sie sich das Spektrum der verfügbaren RAL-Farben in glänzender und matter Oberfläche an. Eine Auflistung der verfügbaren Metalloberflächen für die FüÙe finden Sie auf der nächsten Seite.

Hampshire e' una classica vasca Edwardiana a seduta singola e possiede un bordo con angolata perfetta, per assicurare il massimo comfort. Esplori la nostra gamma di colori RAL con finiture lucide e opache. E' disponibile una gamma di finiture per piedini in metallo - vedi nella pagina seguente.

Hampshire is een klassiek eenzijdige roll-top Edwardiaans bad met een comfortabele rugleuning. Ontdek ons spectrum van RAL-kleuren in glanzende of matte afwerkingen. Een reeks metalen voetafwerkingen is beschikbaar - zie volgende pagina.

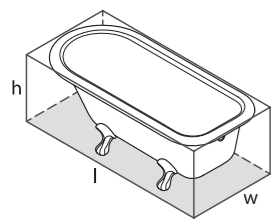
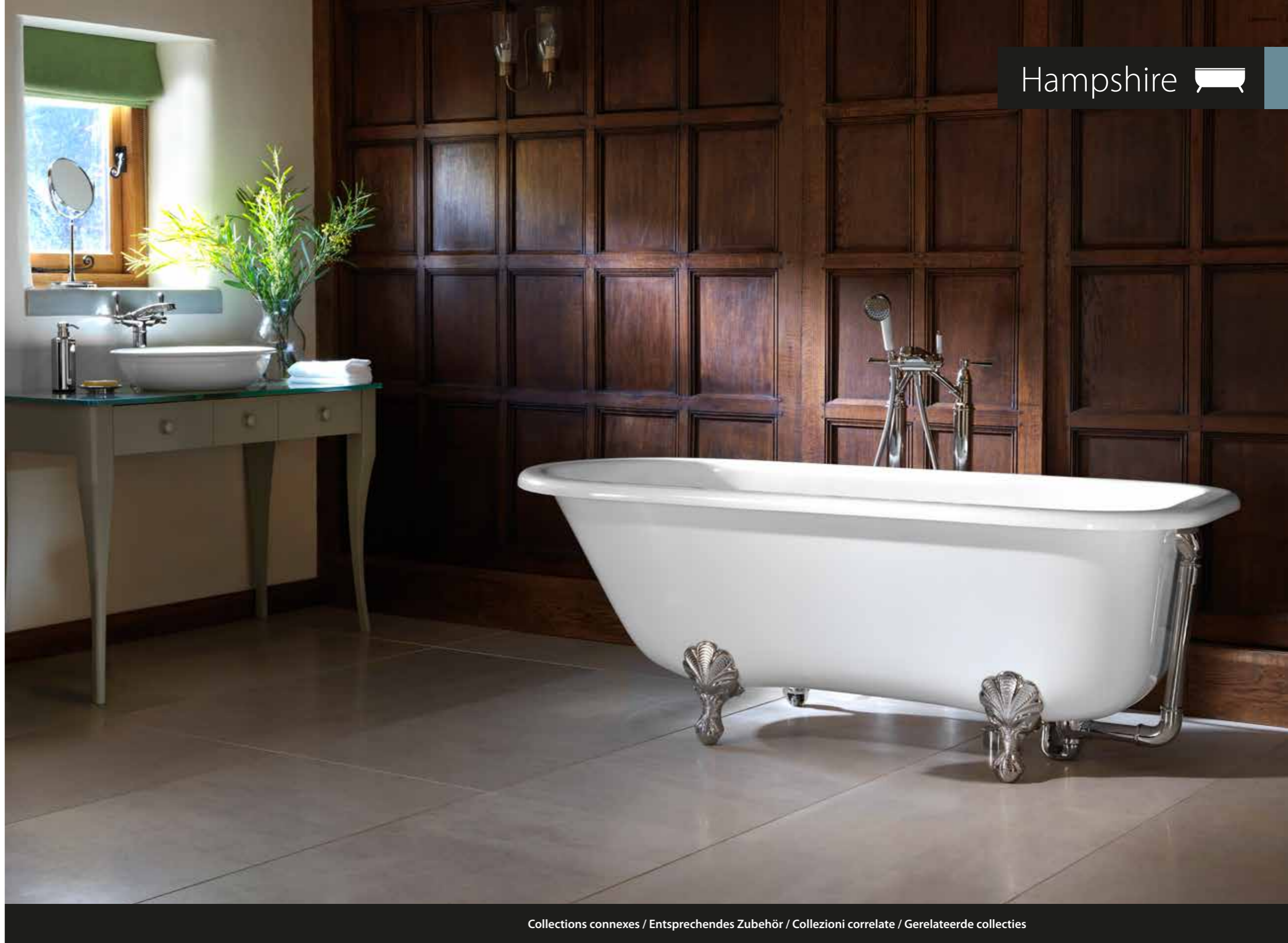

l = 1705mm/67 1/8"
 w = 776mm/30 1/2"
 h = 611mm/24"

○ HAM-N-SW-OF
 ■ PAINT-BATH
 63kg

Collections connexes / Entsprechendes Zubehör / Collezioni correlate / Gerelateerde collecties



○ HAM-N-SW-OF

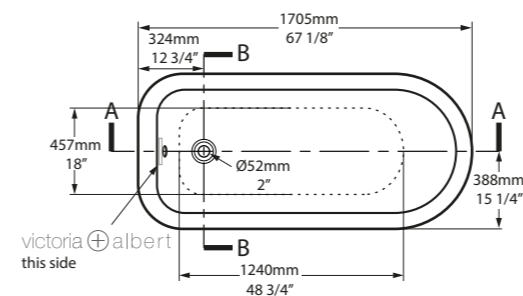

Top View

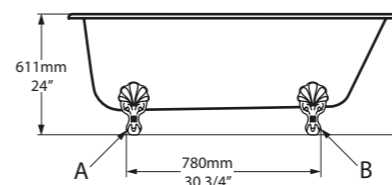

Side View

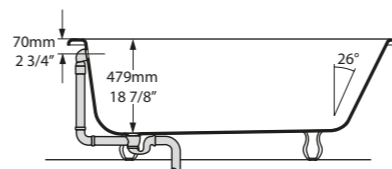

Section AA



Front View

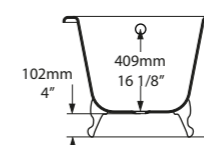

Section BB

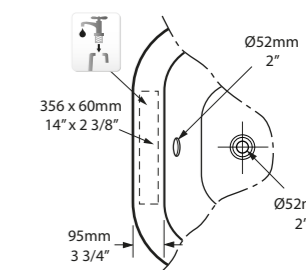

Rim Detail

CE UPC Massachusetts Code cUPC listing by IAPMO

Tap holes can be drilled by installer
 Armaturenlöcher können leicht vom Installateur gebohrt werden
 Les trous de robinetterie peuvent être percés par l'installateur
 Pueden ser perforados por el instalador
 I fori per rubinetti possono essere perforati dall'installatore

Barcelona, Spain

Photography by: José Hevia

Design by: Miriam Barrio Studio

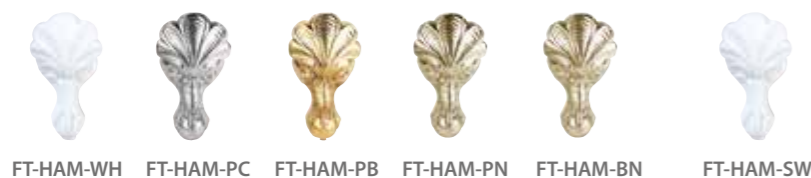

Qc rich in Volcanic Limestone™

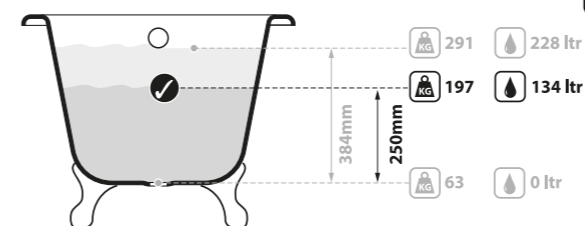

SW QUARRYCAST™ Blanc. QUARRYCAST™ Weiß. QUARRYCAST™ Bianco. QUARRYCAST™ Wit.

Qc rich in Volcanic Limestone™



Personalise. Personaliser. Personalifizieren. Aanpassen.





La forme sculpturale de la baignoire à double assise ionian crée un élément central élégant dans une salle de bains moderne. Un rebord distinctif à largeur variable met en valeur le subtil design oval. Un vide sanitaire en-dessous permet de dissimuler le système d'évacuation. Découvrez notre gamme de couleurs RAL en finition mate ou brillante.

Die skulpturale Anmutung der Double-End Wanne ionian macht sie zum Mittelpunkt jedes modernen Badezimmers. Die randlose Form unterstreicht das harmonische, ovale Design. Mit einem unten liegenden Hohlraum für die Abflussrohre. Schauen Sie sich das Spektrum der verfügbaren RAL-Farben in glänzender und matter Oberfläche an.

Dopo il successo della vasca a seduta ios, la vasca ionian la segue, ma e' piu' lunga, ed offre una generosa inclinatura per godere di un piacevole momento di relax. Una distinta larghezza della base esalta il suo design ovale. Esplori la nostra gamma di colori RAL con finiture lucide e opache.

De elegante vorm van het dubbelzijdige bad Ionian, maakt dit model tot een pronkstuk in de moderne badkamer. De onderscheidende variabele randbreedte zorgt verder voor de subtiële ovale vormgeving. De dubbele bodem zorgt tevens voor eenvoudige en verborgen leiding/afvoer installatie. Ontdek ons spectrum van RAL-kleuren in glanzende of matte afwerkingen.

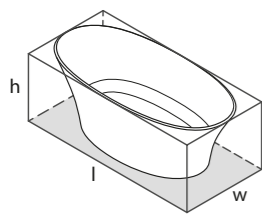

l = 1701mm/67"
w = 793mm/31¼"
h = 614mm/24½"

- INN-N-SW-NO
- Ⓜ INN-M-N-SM-NO
- 🔧 PAINT-BATH
- 82kg





Dallas, Texas, USA

Photography by: Costa Christ

Design by: Studio Thomas James, Inc.



○ INN-N-SW-NO ○ INNM-N-SM-NO

CE Massachusetts Code cUPC listing by IAPMO

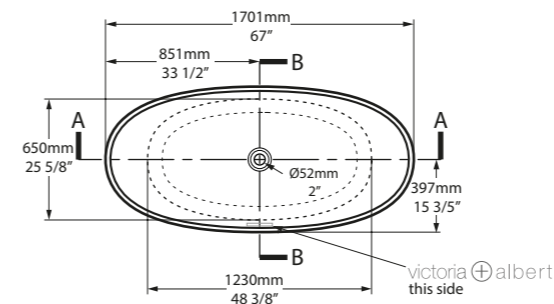

Top View

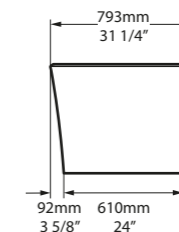

Front View

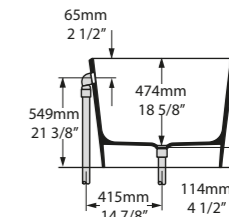

Section BB

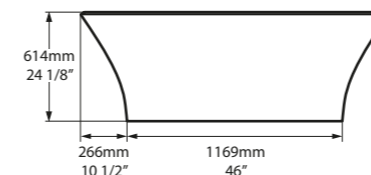

Side View

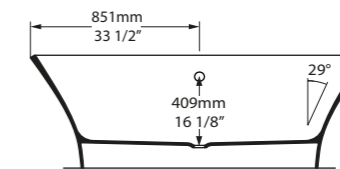

Section AA

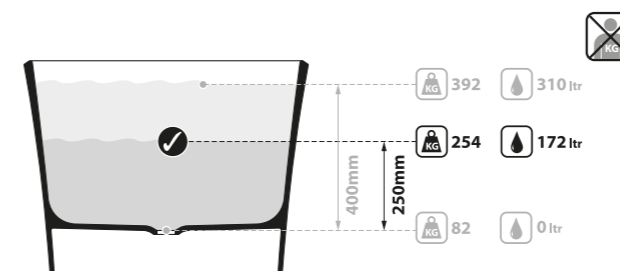

SW QUARRYCAST™ Blanc.
QUARRYCAST™ Weiß.
QUARRYCAST™ Bianco.
QUARRYCAST™ Wit.

SM QUARRYCAST™ Blanc Mat.
QUARRYCAST™ Standard Matt.
QUARRYCAST™ Standard Opaco.
QUARRYCAST™ Standaard Mat.

QC rich in Volcanic Limestone

Personalise.
 Personalisieren.
 Personalifizieren.
 Aanpassen.

La baignoire compacte ios est conçue pour les appartements citadins et les salles de bains où l'espace est limité. A associer aux vasques ios 54 ou ios 80 (page 188-191). Découvrez notre gamme de couleurs RAL en finition mate ou brillante.

Die platzsparende ios Wanne eignet sich besonders für moderne Stadtwohnungen mit oftmals kleineren Badezimmern, oder für Bäder en suite. Zu kombinieren mit den Waschbecken ios 54 oder ios 80 (Seiten 188-191). Schauen Sie sich das Spektrum der verfügbaren RAL-Farben in glänzender und matter Oberfläche an.

La vasca ios e' designata per i moderni appartamenti cittadini e i bagni in camera dove lo spazio è un privilegio. Complementato dai lavabi ios 54 o ios 80 (pagina 188-191). Esplori la nostra gamma di colori RAL con finiture lucide e opache.

De ruimtebesparende ios is ontworpen voor stadsappartementen en suites waar ruimte schaars is. Aangevuld met de ios 54 of ios 80 wasbakken (pagina 188-191). Ontdek ons spectrum van RAL-kleuren in glanzende of matte afwerkingen.

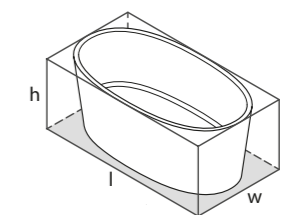

l = 1511mm/59½"
w = 802mm/31¾"
h = 600mm/23¾"



○ IOS-N-SW-NO
Ⓜ IOSM-N-SM-NO
🔧 PAINT-BATH
86kg

Collections connexes / Entsprechendes Zubehör / Collezioni correlate / Gerelateerde collecties



ios 54
Page188



○ IOS-N-SW-NO  ○ IOSM-N-SM-NO 

CE  Massachusetts Code
cUPC listing by IAPMO

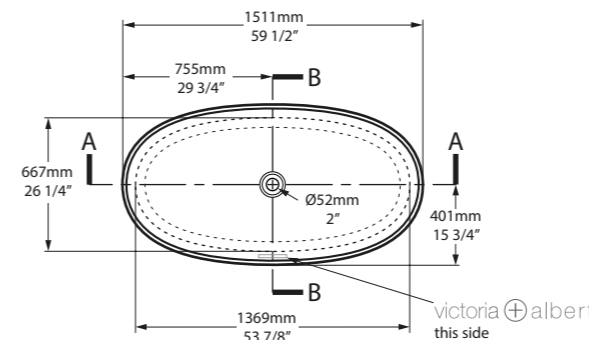

Top View

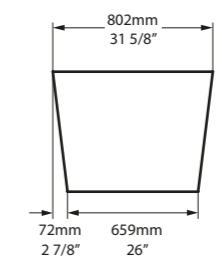

Front View

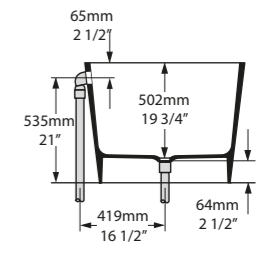

Section BB

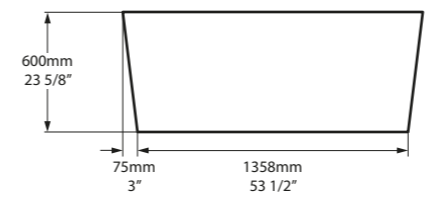

Side View

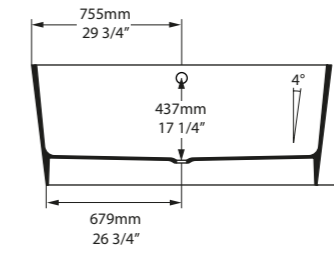

Section AA

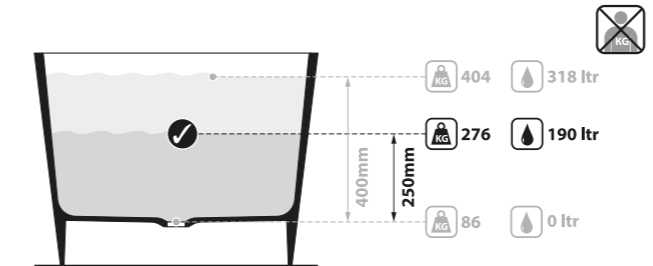

Brighton, Victoria, Australia

Photography by: Dave Kulesza



Design by: Mckimm



SW QUARRYCAST™ Blanc.
QUARRYCAST™ Weiß.
QUARRYCAST™ Bianco.
QUARRYCAST™ Wit.

SM QUARRYCAST™ Blanc Mat.
QUARRYCAST™ Standard Matt.
QUARRYCAST™ Standard Opaco.
QUARRYCAST™ Standaard Mat.

QC rich in Volcanic Limestone

 Personalise.
 Personaliser.
Personalifizieren.
Aanpassen.

Une grande baignoire sabot luxueuse à double dossier relevé, sur socle. La Marlborough s'inspire de la baignoire "bateau" traditionnelle. Découvrez notre gamme de couleurs RAL en finition mate ou brillante.

Eine große, luxuriöse double-end Slipperwanne mit Sockel. Die Marlborough entspricht der klassischen "Bateau" Wanne. Schauen Sie sich das Spektrum der verfügbaren RAL-Farben in glänzender und matter Oberfläche an.

Una vasca capiente e lussuosa con seduta a doppio schienale alto. La Marlborough è basata sulla vasca classica "bateau". Esplori la nostra gamma di colori RAL con finiture lucide e opache.

Een groot luxe dubbelzijdig slipper bad op een sokkel. De vorm van de Marlborough is terug te voeren naar de "bateau" baden. Ontdek ons spectrum van RAL-kleuren in glanzende of matte afwerkingen.

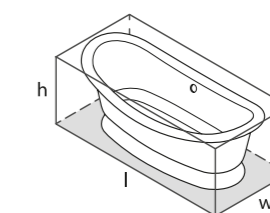

l = 1901mm/74 7/8"
w = 870mm/34 1/4"
h = 728mm/28 5/8"

○ MAR-N-SW-OF + MAR-B-SW
■ PAINT-BATH
80kg

Collections connexes / Entsprechendes Zubehör / Collezioni correlate / Gerelateerde collecties

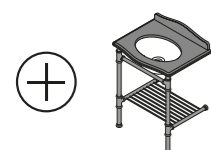

Metallo 61 Quartz
Page 236

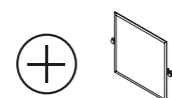

Anatolia 56
Page 242



○ MAR-N-SW-OF + MAR-B-SW ©

CE  Massachusetts Code
cUPC listing by IAPMO

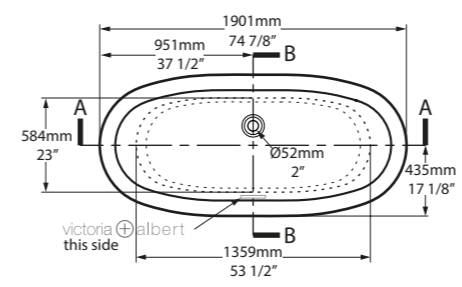

Top View

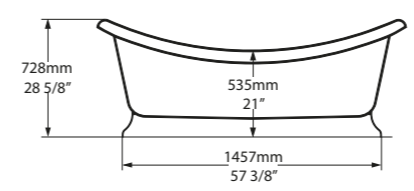

Side View

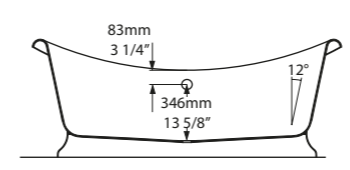

Section AA

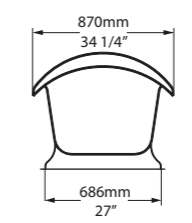

Front View

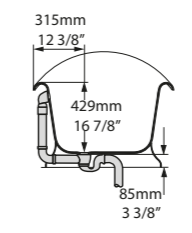

Section BB

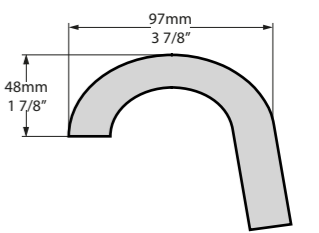
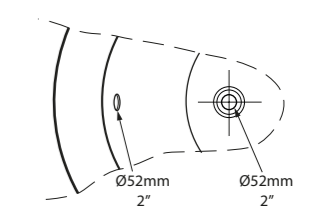

Rim Detail

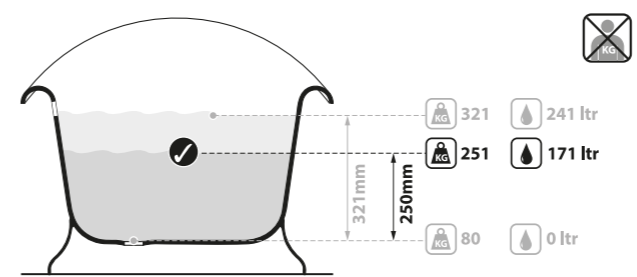

Watch Hill, Rhode Island, USA

Photography by: © Stephen Kent Johnson/OTTO

Design by: Studio Giancarlo Valle

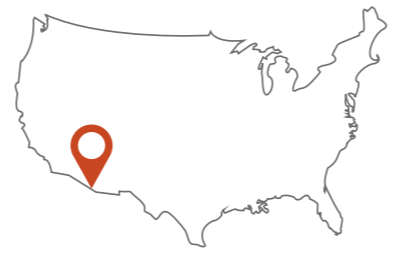

QUARRYCAST™ Blanc.
QUARRYCAST™ Weiß.
QUARRYCAST™ Bianco.
QUARRYCAST™ Wit.



Personalise.
Personaliser.
Personalizzieren.
Aanpassen.

Ajoutez une touche de sophistication instantanée à n'importe quelle salle de bains - une élégance minimaliste qui descend gracieusement jusqu'au sol. Dispose d'un vide sanitaire pour le raccordement du système d'évacuation. Découvrez notre gamme de couleurs RAL en finition mate ou brillante.

Perfektionieren Sie jedes Badezimmer im Nu: Minimalistische Eleganz bis auf den Boden. Mit einem unten liegenden Hohlraum für die Abflussrohre. Schauen Sie sich das Spektrum der verfügbaren RAL-Farben in glänzender und matter Oberfläche an.

In un'istante rende sofisticata qualsiasi stanza da bagno. Eleganza minimalista nella forma di una gettata unica che scende con grazia sul pavimento. Esplori la nostra gamma di colori RAL con finiture lucide e opache.

Voegt een verfijnde touch toe aan alle badkamers - minimalistische elegantie uit één enkel stuk gegoten tot op de vloer met dubbele bodem voor eenvoudige en verborgen leiding werk. Ontdek ons spectrum van RAL-kleuren in glanzende of matte afwerkingen.

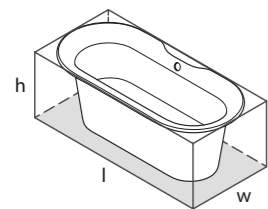
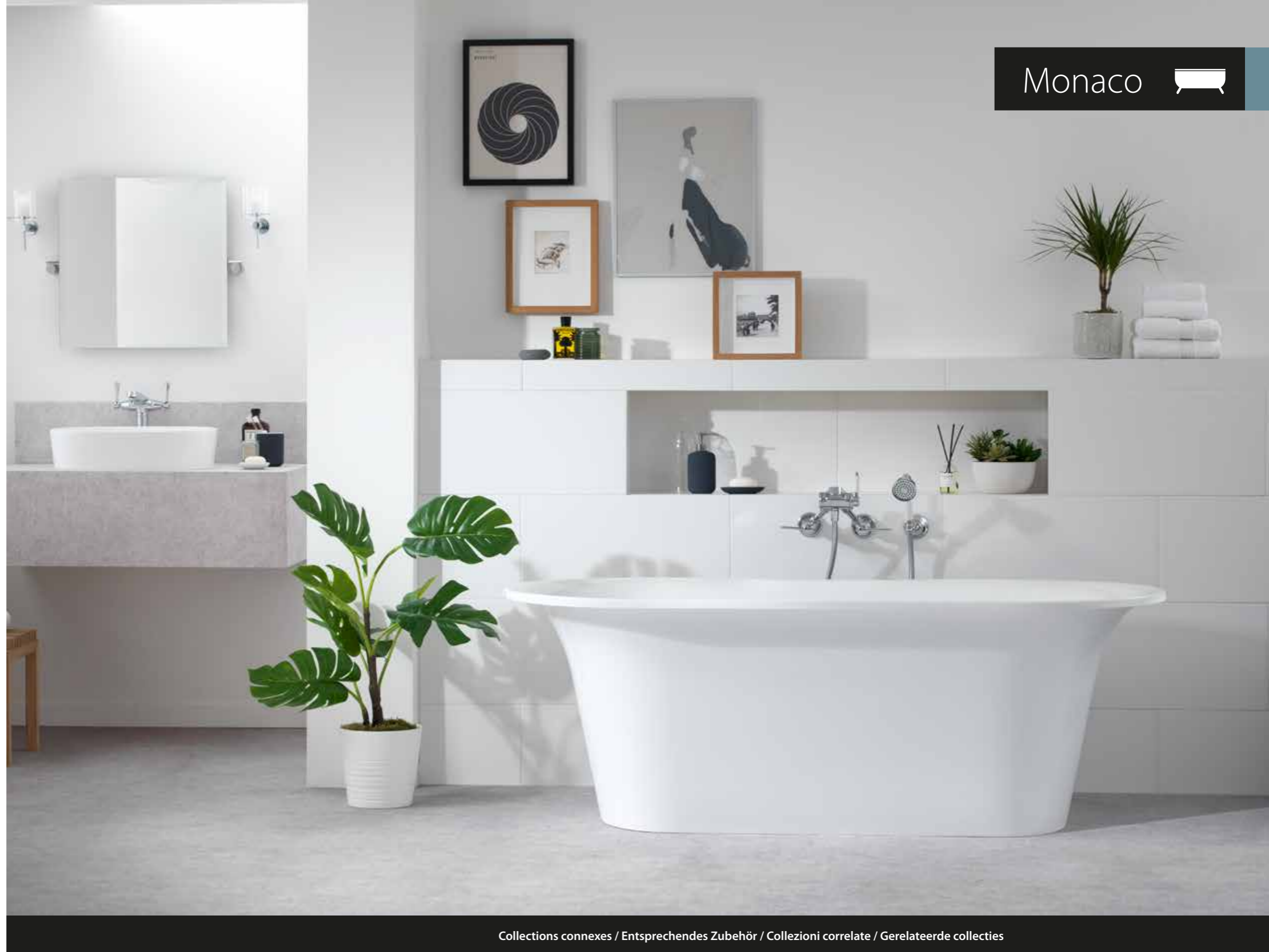

l = 1744mm/68⁵/₈"
w = 806mm/31³/₄"
h = 621mm/24¹/₂"

○ MON-N-SW-OF
■ PAINT-BATH
69kg

Collections connexes / Entsprechendes Zubehör / Collezioni correlate / Gerelateerde collecties

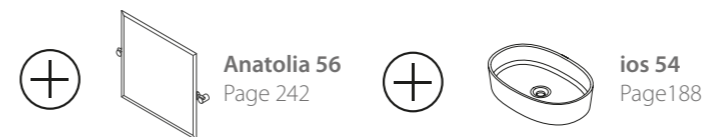



○ MON-N-SW-OF

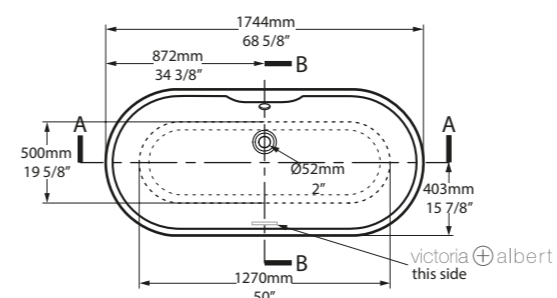

Top View

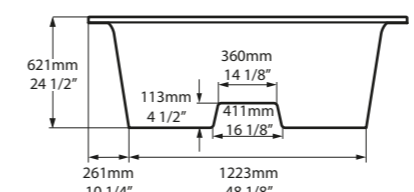

Side View

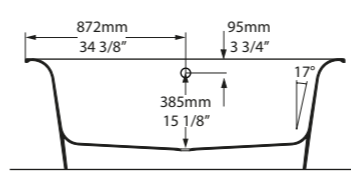

Section AA

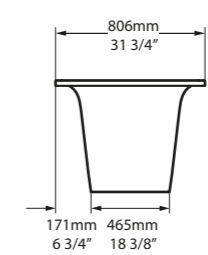

Front View

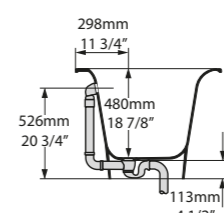

Section BB

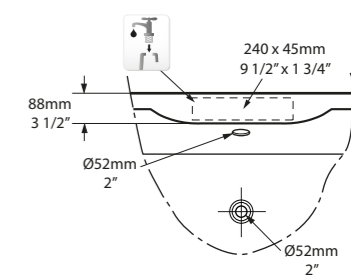

Rim Detail

Tap holes can be drilled by installer
 Armaturenlöcher können leicht vom Installateur gebohrt werden
 Les trous de robinetterie peuvent être percés par l'installateur
 Pueden ser perforados por el instalador
 I fori per rubinetti possono essere perforati dall'installatore

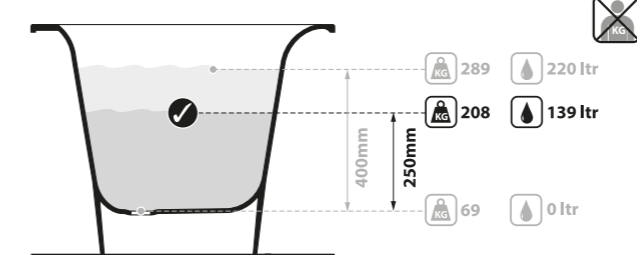

Newport Beach, California, USA

Photography by: Lane Dittoe
 Design by: Mindy Gayer Design



SW
 QUARRYCAST™ Blanc.
 QUARRYCAST™ Weiß.
 QUARRYCAST™ Bianco.
 QUARRYCAST™ Wit.
 rich in volcanic limestone

Personalise.
 Personnaliser.
 Personalizieren.
 Aanpassen.



Une magnifique baignoire en îlot sans rebord, de faible hauteur et dotée de courbes subtiles. Compacte et conçue avec un design ergonomique, la baignoire assure une forte présence architecturale dans les plus petites salles de bains. Egalement disponible dans un plus grand format, appelé Mozzano 2. Découvrez notre gamme de couleurs RAL en finition mate ou brillante.

Mozzano ist eine wunderbar verarbeitete Wanne, randlos und freistehend, mit niedriger Einstiegshöhe und schlichten Formen. Die ergonomisch gestaltete, kompakte Wanne entfaltet ihre starke Präsenz auch in kleineren Bädern. Auch lieferbar in größerem Format, unter der Bezeichnung Mozzano 2. Schauen Sie sich das Spektrum der verfügbaren RAL-Farben in glänzender und matter Oberfläche an.

Una stupenda vasca freestanding realizzata senza bordi e disegnata con curve decise dal design ergonomico. Mozzano offre un pezzo unico per spazi compatti. Disponibile anche in un formato più grande chiamato Mozzano 2. Esplori la nostra gamma di colori RAL con finiture lucide e opache.

Een prachtig vormgegeven randloos vrijstaand bad, ontworpen met vertrouwde lijnen en een ergonomisch design; Mozzano levert een sterke architectonische aanwezigheid in compacte ruimtes. Ook beschikbaar in een groter formaat; Mozzano 2. Ontdek ons spectrum van RAL-kleuren in glanzende of matte afwerkingen.

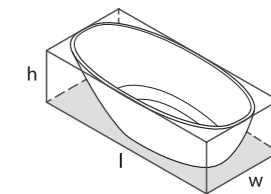

l = 1645mm/64¾"
w = 741mm/29⅞"
h = 502mm/19¾"

○ MOZ-N-SW-NO
⊗ MOZM-N-SM-NO
🔧 PAINT-BATH
61kg

○ MOZ-N-SW-NO  ○ SM MOZM-N-SM-NO 

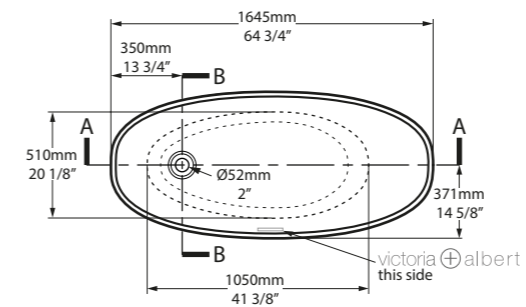

Top View

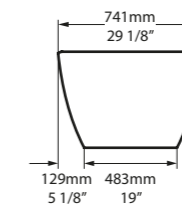

Front View

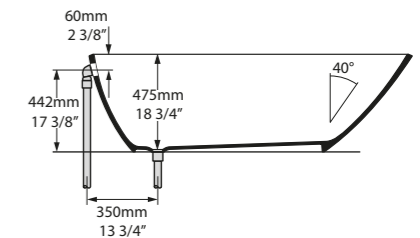

Section AA

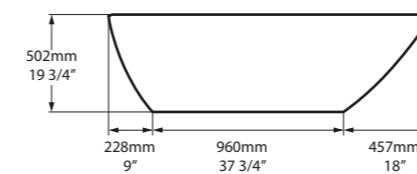

Side View

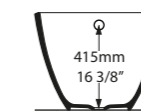

Section BB

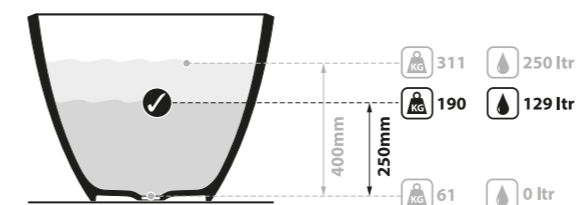

Cotswolds, United Kingdom

Photography by: Paul Craig

Design by: Pippa Paton Design



SW QUARRYCAST™ Blanc.
QUARRYCAST™ Weiß.
QUARRYCAST™ Bianco.
QUARRYCAST™ Wit.

SM QUARRYCAST™ Blanc Mat.
QUARRYCAST™ Standard Matt.
QUARRYCAST™ Standard Opaco.
QUARRYCAST™ Standaard Mat.



Personalise.
Personalisieren.
Personalifizieren.
Aanpassen.



○ MO2-N-SW-NO  ◉ MO2M-N-SM-NO 

  Massachusetts Code
cUPC listing by IAPMO

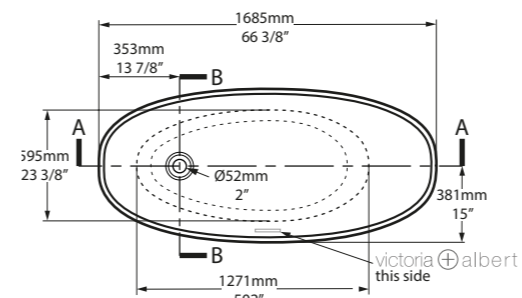

Top View

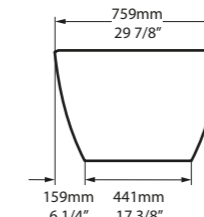

Front View

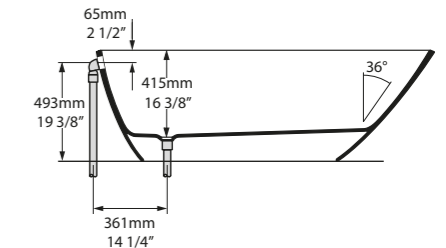

Section AA

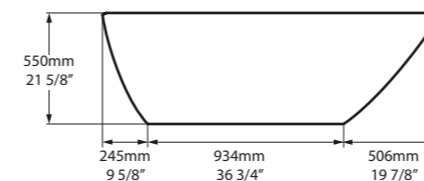

Side View

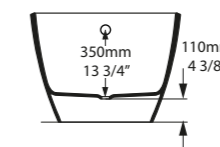

Section BB

Mozzano 2 suit le même design que la baignoire Mozzano mais avec des dimensions plus grandes. Dispose d'un vide sanitaire pour le raccordement du système d'évacuation. Découvrez notre gamme de couleurs RAL en finition mate ou brillante.

Mozzano 2 folgt dem gleichen Design wie die Mozzano Wanne, hat jedoch kompaktere Maße. Zudem besitzt sie einen unten liegenden Hohlraum für die Abflussrohre. Schauen Sie sich das Spektrum der verfügbaren RAL-Farben in glänzender und matter Oberfläche an.

Mozzano 2 offre lo stesso design della vasca Mozzano ma in dimensioni piu' grande. Caratterizzata da un vuoto sotto per l'impianto idraulico. Esplori la nostra gamma di colori RAL con finiture lucide e opache.

Mozzano 2 volgt het zelfde design als het Mozzano bad, maar is langer en hoger. Het heeft daarentegen een dubbele bodem, voor eenvoudige installatie van leidingwerk. Ontdek ons spectrum van RAL-kleuren in glanzende of matte afwerkingen.

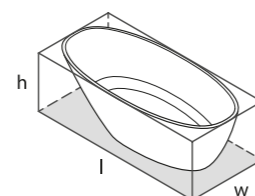

l = 1685mm/66 3/8"
w = 759mm/29 7/8"
h = 550mm/21 5/8"

○ MO2-N-SW-NO
◉ MO2M-N-SM-NO
 PAINT-BATH
84kg

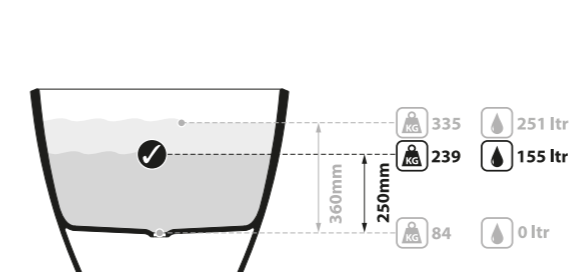

 QUARRYCAST™ Blanc.
QUARRYCAST™ Weiß.
QUARRYCAST™ Bianco.
QUARRYCAST™ Wit.

 QUARRYCAST™ Blanc Mat.
QUARRYCAST™ Standard Matt.
QUARRYCAST™ Standard Opaco.
QUARRYCAST™ Standaard Mat.

 rich in
Volcanic
Limestone™

 Personalise.
Personaliser.
Personalifizieren.
Aanpassen.



En forme de coquille, la baignoire Napoli, se caractérise par un design audacieux et un profil bas, et apporte une vraie touche architecturale à une salle de bains moderne. A associer à la vasque Napoli 57 (page 194). Découvrez notre gamme de couleurs RAL en finition mate ou brillante.

Mit dem ausgefallenen Design gleich einer niedrig geformten Schale wird die Napoli Wanne zum dramatischen, architektonischen Mittelpunkt jedes modernen Badezimmers. Zu kombinieren mit dem Napoli 57 Waschbecken (Seite 194). Schauen Sie sich das Spektrum der verfügbaren RAL-Farben in glänzender und matter Oberfläche an.

Di forma e struttura uniche, la vasca Napoli offre la semplicità di una vasca senza bordi con facilità di accesso, senza però perdere il comfort di una vasca lussuosa. Complementata dal lavabo Napoli 57 (pagina 194). Esplora Esplori la nostra gamma di colori RAL con finiture lucide e opache.

Vervaardigd als een half ei, voegt de Napoli een teatrale en architectonische glamour aan de moderne badkamer toe. Aangevuld met de Napoli 57 wasbak (pg 194). Ontdek ons spectrum van RAL-kleuren in glanzende of matte afwerkingen.

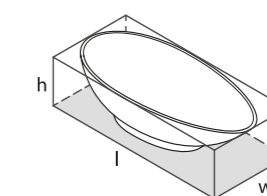

l = 1900mm/74¾"
w = 845mm/33¼"
h = 503mm/19¾"

- NAP-N-SW-NO
- ⊗ NAPM-N-SM-NO
- 🔧 PAINT-BATH

71kg

Collections connexes / Entsprechendes Zubehör / Collezioni correlate / Gerelateerde collecties



Napoli 57
Page 194

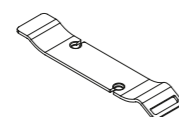

Tombolo 10
Page 60



○ NAP-N-SW-NO  ◉ NAPM-N-SM-NO 

  Massachusetts Code
cUPC listing by IAPMO

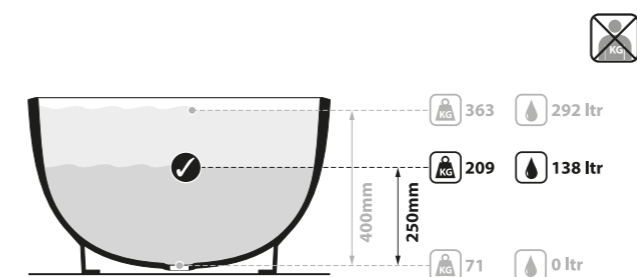
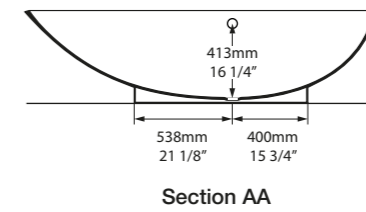
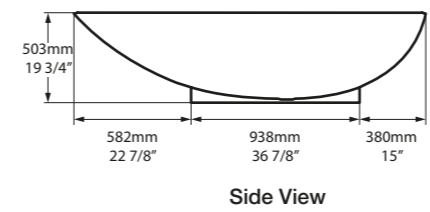
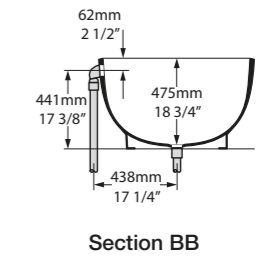
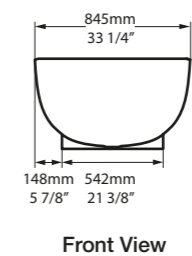
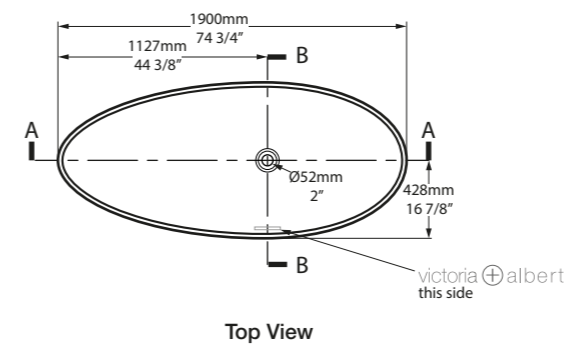

Kiev, Ukraine

Photography by: Stanislav Belyi

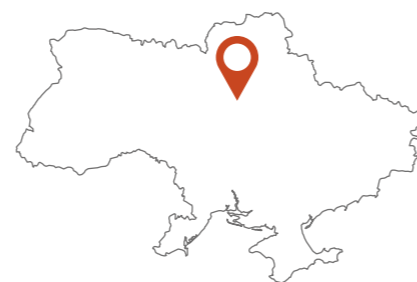

Design by: Stas Belyi Design



SW QUARRYCAST™ Blanc.
QUARRYCAST™ Weiß.
QUARRYCAST™ Bianco.
QUARRYCAST™ Wit.

SM QUARRYCAST™ Blanc Mat.
QUARRYCAST™ Standard Matt.
QUARRYCAST™ Standard Opaco.
QUARRYCAST™ Standaard Mat.

 rich in
Volcanic
Limestone

  Personalise.
Personaliser.
Personalifizieren.
Aanpassen.

MENEGHELLO PAOLELLI ASSOCIATI

Baptisée d'après le lieu de naissance du premier roi de la dynastie Tudor d'Angleterre, la baignoire Pembroke évoque une élégance royale, accentuée par des coins nets et des rebords précis. Profonde et à double assise, la baignoire offre une luxueuse expérience du bain. Dispose d'un vide sanitaire pour le raccordement du système d'évacuation. Conçue par Meneghello Paoelli Associati. A associer à la vasque Pembroke 52 (page 218). Découvrez notre gamme de couleurs RAL en finition mate ou brillante.

Die Wanne Pembroke wurde benannt nach dem Geburtsort des ersten englischen Tudor-Königs. Sie strahlt einen royalen Anspruch aus, besticht durch klare Ecken und einen eleganten Rand. Dank ihrer Tiefe und dem doppelten Ende bietet diese Wanne ein sehr luxuriöses Badeerlebnis. Mit einem unten liegenden Hohlraum für die Abflussrohre. Entworfen vom Designstudio Meneghello Paoelli Associati. Schauen Sie sich das Spektrum der verfügbaren RAL-Farben in glänzender und matter Oberfläche an. Zu kombinieren mit dem Pembroke 52 Waschbecken (Seite 218).

La vasca Pembroke prende il nome dal luogo di nascita del primo Re Tudor d'Inghilterra ed evoca un'eleganza regale, accentuata da angoli netti ed un bordo pulito. Profonda e a doppia seduta, la vasca da bagno regala una lussuosa esperienza. Progettato da Meneghello Paoelli Associati. Disponibile in sette finiture di colore. Complementata dal lavabo Pembroke 52 (Pagina 218). Esplori la nostra gamma di colori RAL con finiture lucide e opache.

Vernoemd naar de geboorteplaats van Engeland's eerste Tudor koning, heeft de Pembroke een vorstelijke elegantie, geaccentueerd door scherpe hoeken en een nette rand. Het bad is diep en dubbelzijdig voor een luxe badervaring en tevens een dubbele bodem voor eenvoudige installatie van leiding werk. Ontworpen door Meneghello Paoelli Associati. Ontdek ons spectrum van RAL-kleuren in glanzende of matte afwerkingen. Aangevuld met de Pembroke 52 wasbak (pg 218).

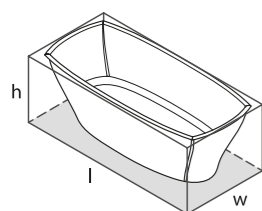

l = 1765mm/69½"
w = 798mm/31¾"
h = 578mm/22¾"

○ PEM-N-SW-NO
🚰 PAINT-BATH
88kg



○ PEM-N-SW-NO 

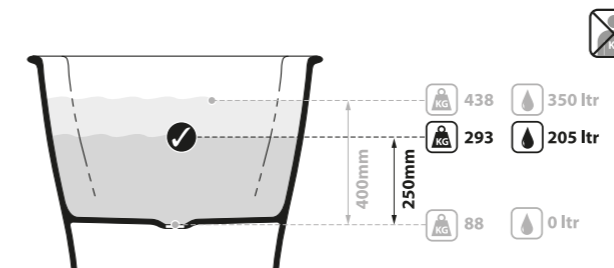
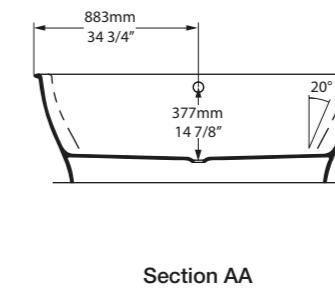
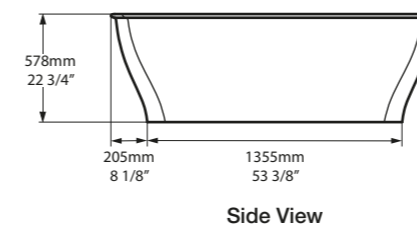
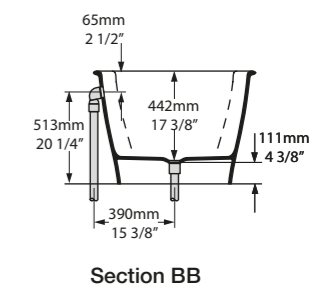
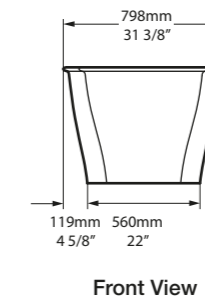
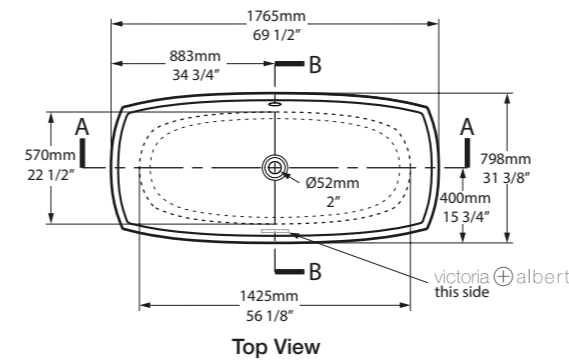

QUARRYCAST™ Blanc.
QUARRYCAST™ Weiß.
QUARRYCAST™ Bianco.
QUARRYCAST™ Wit.



Personalise.
Personaliser.
Personalifizieren.
Aanpassen.

Inspirée par la mer, la baignoire à double assise Pescadero aux rebords ondulants, a été conçue pour former une « vague » caractéristique et asymétrique. Dispose d'un vide sanitaire pour le raccordement du système d'évacuation. Découvrez notre gamme de couleurs RAL en finition mate ou brillante.

Inspiriert vom Meer besitzt die doppelseitige Wanne Pescadero einen wellenförmigen Rand gleich einer asymmetrischen Woge. Mit einem unten liegenden Hohlraum für die Abflussrohre. Schauen Sie sich das Spektrum der verfügbaren RAL-Farben in glänzender und matter Oberfläche an.

Ispirato al mare, il Pescadero a doppia seduta è dotato di un'orlo ondulato, progettato per formare una distinta e asimmetrica 'onda'. Esplori la nostra gamma di colori RAL con finiture lucide e opache.

Geïnspireerd door de zee, beschikt de dubbelzijdige Pescadero over een golvende rand, ontworpen om een onderscheidende, asymmetrische 'wave' te vormen. Beschikt over een dubbele bodem voor eenvoudige installatie van leidingwerk. Ontdek ons spectrum van RAL-kleuren in glanzende of matte afwerkingen.

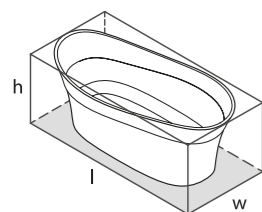

l = 1695mm/66¾"
w = 798mm/31½"
h = 653mm/25¾"

○ PES-N-SW-NO
■ PAINT-BATH
75kg





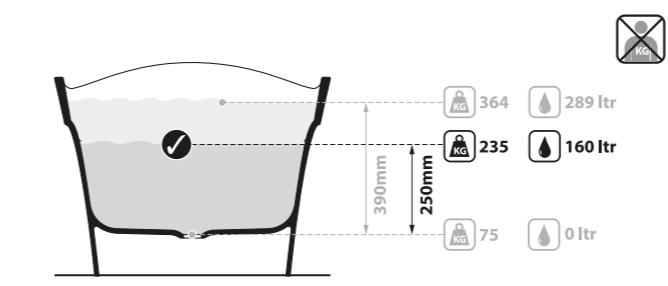
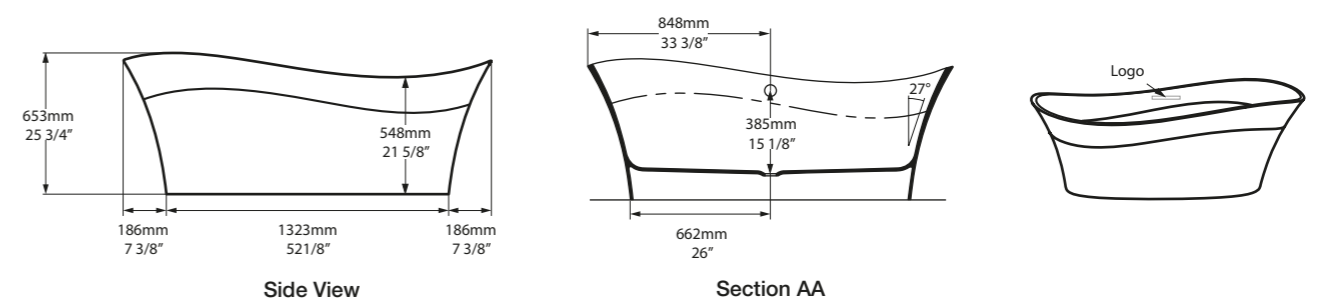
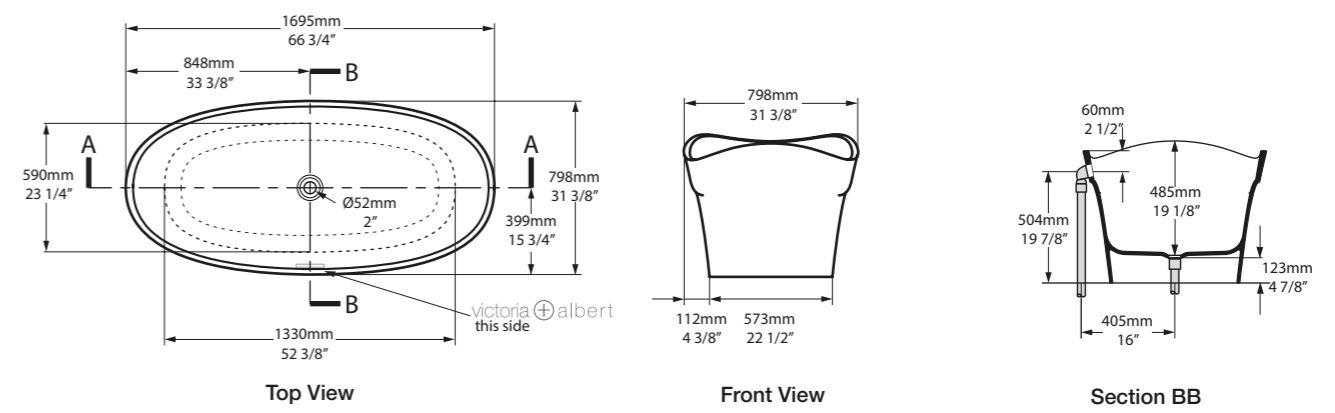

○ PES-N-SW-NO 

CE  Massachusetts Code
cUPC listing by IAPMO
Registered Design



SW QUARRYCAST™ Blanc.
QUARRYCAST™ Weiß.
QUARRYCAST™ Bianco.
QUARRYCAST™ Wit.

QC rich in volcanic Limestone*

 Personalise.
 Personaliser.
Personalisieren.
Aanpassen.



Une baignoire en îlot opulente à rebords arrondis et à double assise qui offre une symétrie classique. Un élément central de la pièce. S'associe parfaitement à la vasque Radford 51 (page 196). Découvrez notre gamme de couleurs RAL en finition mate ou brillante.

Die opulente, freistehende Wanne bietet klassische Symmetrie. Sie ist beidseitig nutzbar und besticht mit einem ausladenden, elegant verarbeiteten Rand. Zu kombinieren mit dem Radford 51 Waschbecken (Seite 196). Schauen Sie sich das Spektrum der verfügbaren RAL-Farben in glänzender und matter Oberfläche an.

Una ricca vasca freestanding a doppia seduta con dettaglio elegante sul bordo, offre una simmetria classica. Un vero pezzo da esposizione. Complementata perfettamente dal lavabo Radford 51 (pagina 196). Esplori la nostra gamma di colori RAL con finiture lucide e opache.

Een weelderig dubbelzijdig roll-top vrijstaand bad met elegante rand detaillering, waarbij klassieke symmetrie. Een echt kunststuk. Perfect aangevuld door de Radford 51 wasbak (pg 196). Ontdek ons spectrum van RAL-kleuren in glanzende of matte afwerkingen.

Collections connexes / Entsprechendes Zubehör / Collezioni correlate / Gerelateerde collecties

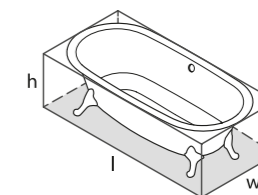

l = 1902mm/74 7/8"
w = 910mm/35 7/8"
h = 650mm/25 5/8"

○ RAD-N-SW-OF
■ PAINT-BATH
77kg

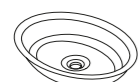

Radford 51
Page 196



○ RAD-N-SW-OF 

CE  Massachusetts Code
cUPC listing by IAPMO
Registered Design

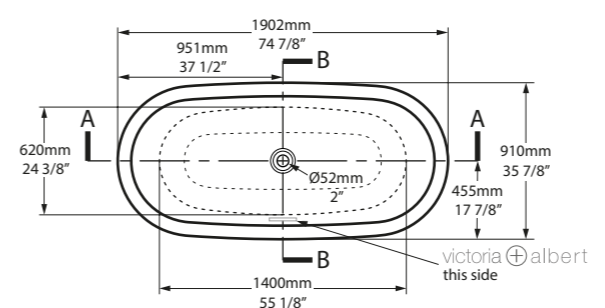

Top View

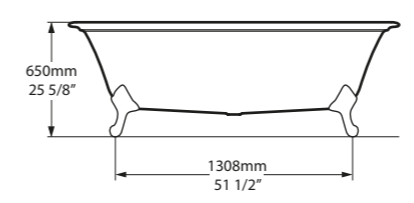

Side View

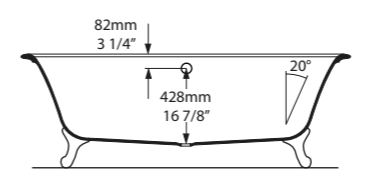

Section AA

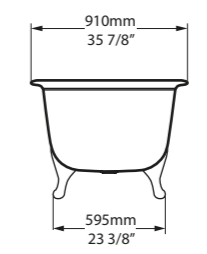

Front View

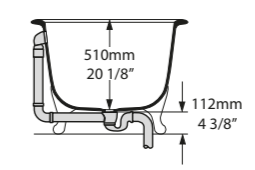

Section BB

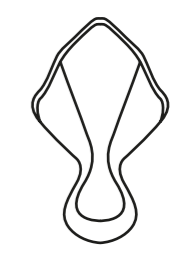

Rim Detail

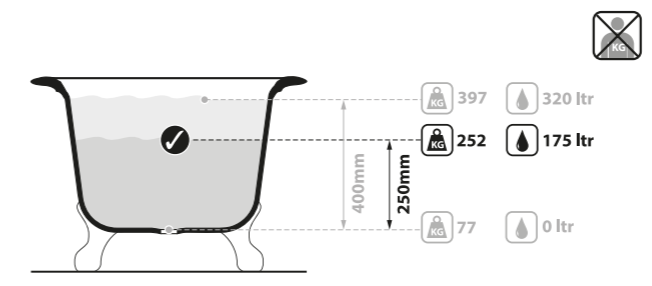

QUARRYCAST™ Blanc.
QUARRYCAST™ Weiß.
QUARRYCAST™ Bianco.
QUARRYCAST™ Wit.



Personalise.
Personaliser.
Personalisieren.
Aanpassen.



FT-RAD-SW





La baignoire Ravello allie lignes sobres et franches à des courbes plus douces. Dispose d'un vide sanitaire pour le raccordement du système d'évacuation. A associer à la vasque Ravello 60 (page 198). Découvrez notre gamme de couleurs RAL en finition mate ou brillante.

Gerade Linien verbinden sich mühelos mit sanften Kurven. Mit einem unten liegenden Hohlraum für die Abflussrohre. Zu kombinieren mit dem Ravello 60 Waschbecken (Seite 198). Schauen Sie sich das Spektrum der verfügbaren RAL-Farben in glänzender und matter Oberfläche an.

Linee audaci si combinano con curve dolci. Complementato dal lavabo Ravello 60 (pagina 198). Esplori la nostra gamma di colori RAL con finiture lucide e opache.

Strakke rechte lijnen combineren moeiteloos met zachte rondingen. Zijn dubbele bodem biedt eenvoudige instalatie van leidingwerk. Aangevuld met de Ravello 60 wasbak (pg 198). Ontdek ons spectrum van RAL-kleuren in glanzende of matte afwerkingen.

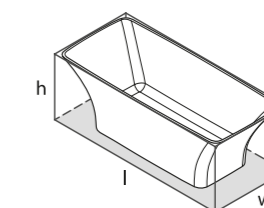

l = 1743mm/68 7/8"
w = 753mm/29 5/8"
h = 597mm/23 1/2"

○ RAV-N-SW-NO
👤 PAINT-BATH
81kg

Collections connexes / Entsprechendes Zubehör / Collezioni correlate / Gerelateerde collecties



Ravello 60
Page 198



Dallas, Texas, USA

Photography by: Nathan Schroder

Design by: Morgan Farrow Interiors

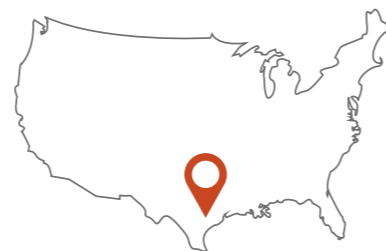

○ RAV-N-SW-NO

Massachusetts Code
cUPC listing by IAPMO

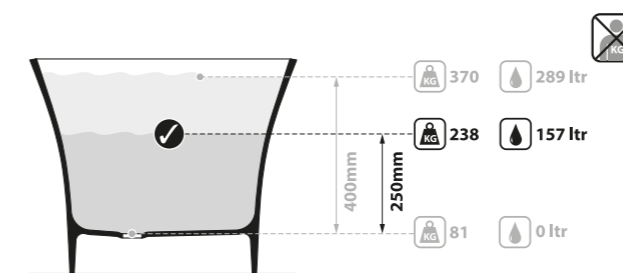
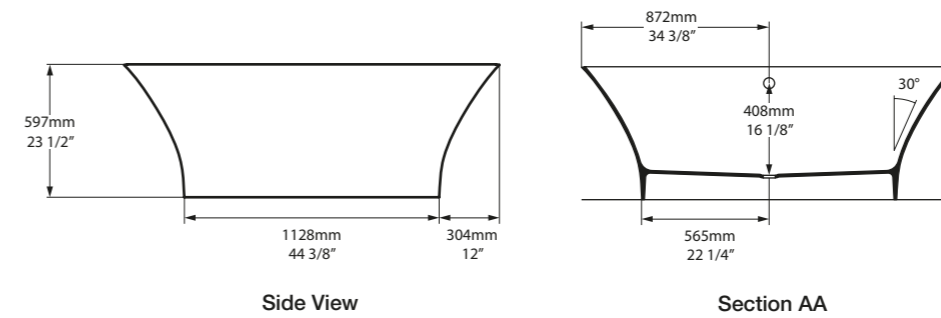
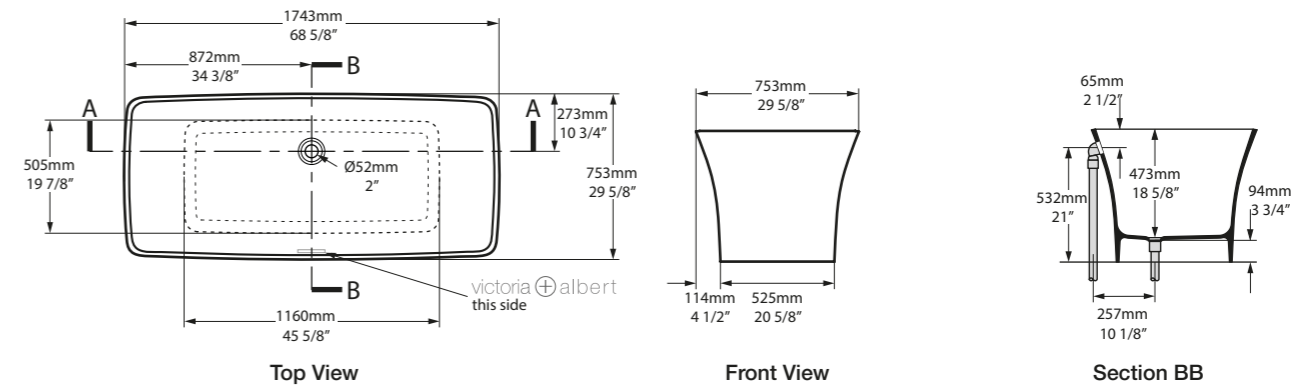

SW
 QUARRYCAST™ Blanc.
 QUARRYCAST™ Weiß.
 QUARRYCAST™ Bianco.
 QUARRYCAST™ Wit.

QC rich in volcanic Limestone

Personalise.
 Personaliser.
 Personalifizieren.
 Aanpassen.

Une baignoire à double assise élégante disposant de pieds dits "en rouleaux", caractéristiques du style Art Déco. Son design international s'intègre aussi bien dans un décor moderne que d'époque. Découvrez notre gamme de couleurs RAL en finition mate ou brillante.

Eine elegante Wanne mit doppelter Rückenlehne und Art-Deco Füßen. Der internationale Stil eignet sich für moderne und zeitlose Einrichtungen. Schauen Sie sich das Spektrum der verfügbaren RAL-Farben in glänzender und matter Oberfläche an.

Questa è un'elegante vasca a doppio schienale con i piedi in stile "art deco". Il tipo di modello si adatta facilmente ad ambienti sia moderni che d'epoca. Esplori la nostra gamma di colori RAL con finiture lucide e opache.

Een elegante dubbelzijdige Roll-Top bad met Art Deco poten. Internationaal gestyled past dit model zowel in moderne als eigentijdse badkamers. Ontdek ons spectrum van RAL-kleuren in glanzende of matte afwerkingen.



Qc rich in Volcanic Limestone™

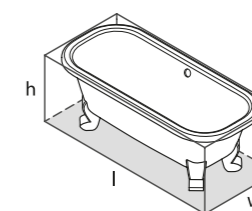

l = 1675mm/66"
w = 745mm/29 3/8"
h = 603mm/23 3/4"

○ RIC-N-SW-OF
■ PAINT-BATH
62kg

Collections connexes / Entsprechendes Zubehör / Collezioni correlate / Gerelateerde collecties



Radford 51
Page 196



Killara, New South Wales, Australia

Photography by: Mitchell Fong

Design by: Rocco Revolution



RIC-N-SW-OF

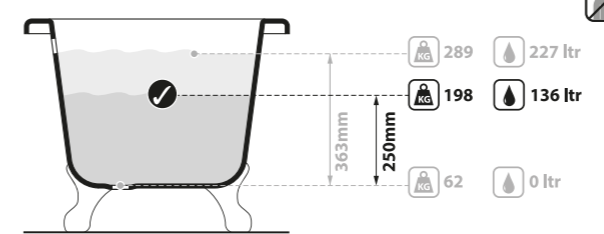
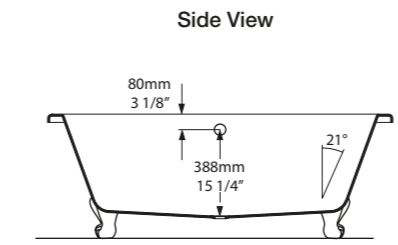
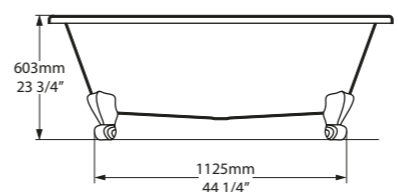
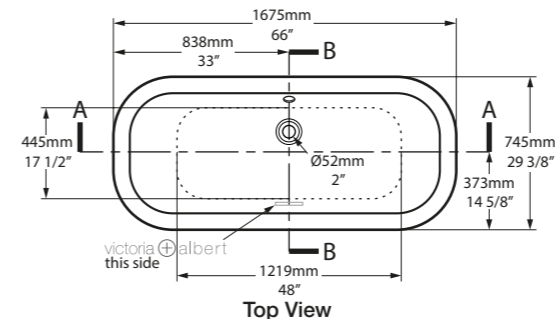

Massachusetts Code cUPC listing by IAPMO

Tap holes can be drilled by installer
 Armaturenlöcher können leicht vom Installateur gebohrt werden
 Les trous de robinetterie peuvent être percés par l'installateur
 Pueden ser perforados por el instalador
 I fori per rubinetti possono essere perforati dall'installatore

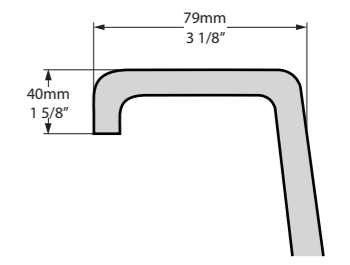
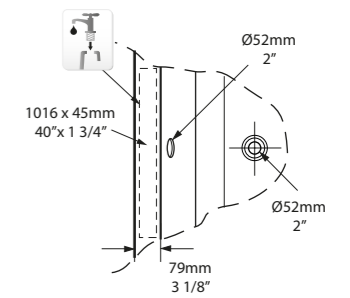
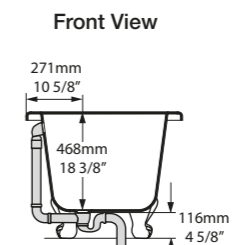
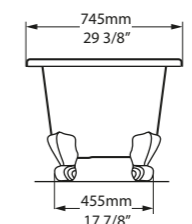

Section BB

Rim Detail

QUARRYCAST™ Blanc.
 QUARRYCAST™ Weiß.
 QUARRYCAST™ Bianco.
 QUARRYCAST™ Wit.

rich in Volcanic Limestone

Personalise.
 Personnaliser.
 Personalisieren.
 Aanpassen.



Plus grande que la baignoire victorienne traditionnelle, dotée, en option, de pieds style "patte de lion" ou modernes. Découvrez notre gamme de couleurs RAL en finition mate ou brillante. Une gamme de finitions pour pieds en métal est disponible - voir page suivante.

Länger als die herkömmlichen viktorianischen Wannen und mit einer Auswahl an traditionellen Löwenfüßen oder modernen Varianten. Schauen Sie sich das Spektrum der verfügbaren RAL-Farben in glänzender und matter Oberfläche an. Eine Auflistung der verfügbaren Metalloberflächen für die Füße finden Sie auf der nächsten Seite.

Una vasca a schienale alto superbamente confortevole. Più lunga della vasca Vittoriana a schienale alto tradizionale, con piedi a zampe di leone o un'opzione più moderna. Esplori la nostra gamma di colori RAL con finiture lucide e opache. E' disponibile una gamma di finiture per piedini in metallo - vedi nella pagina seguente.

Langer dan de traditionele Victoriaanse Slipperbad, met zowel leeuwen poten also moderne poot opties. Ontdek ons spectrum van RAL-kleuren in glanzende of matte afwerkingen. Een gamma van afwerkingen van metaal poten zijn beschikbaar (zie volgende blz).

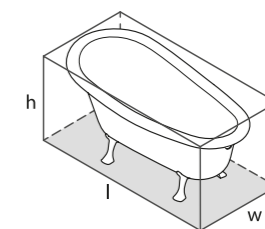

l = 1704mm/67 1/8"
w = 809mm/31 7/8"
h = 752mm/29 5/8"

○ ROX-N-SW-OF
■ PAINT-BATH
60kg



○ ROX-N-SW-OF 

CE  Massachusetts Code cUPC listing by IAPMO

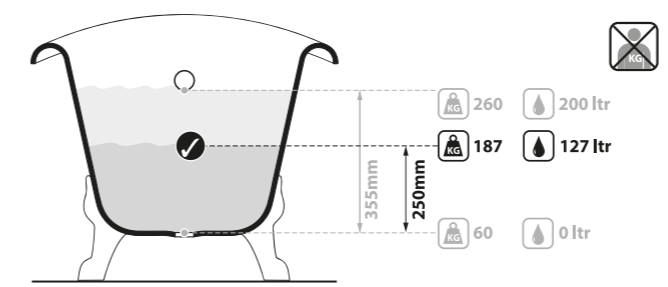
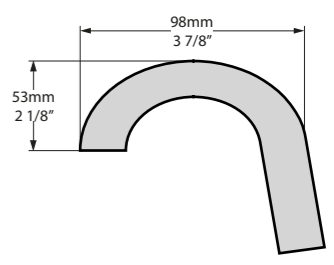
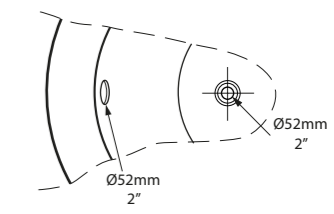
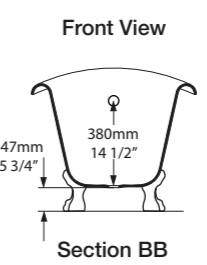
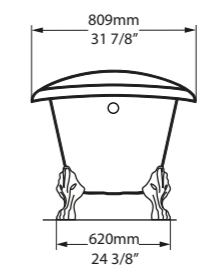
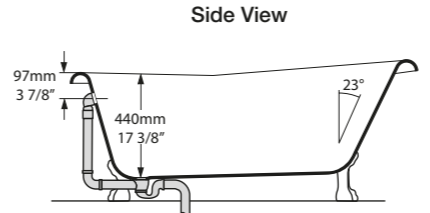
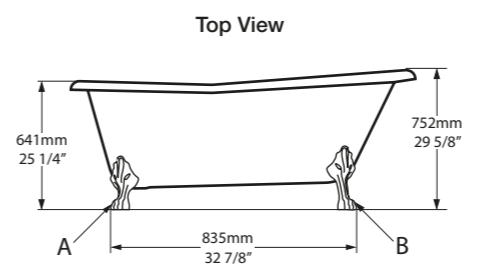
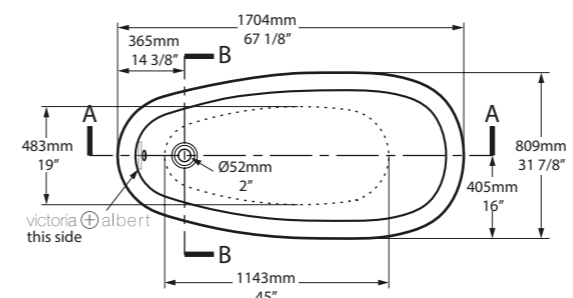

Scottsdale, Arizona, USA

Photography by: Julianne Mckay, Pearl Blossom Photography



Design by: Avril Interiors



 rich in Volcanic Limestone™

 QUARRYCAST™ Blanc.
QUARRYCAST™ Weiß.
QUARRYCAST™ Bianco.
QUARRYCAST™ Wit.

 rich in Volcanic Limestone™

  Personalise.
Personaliser.
Personalifizieren.
Aanpassen.

Les lignes parfaites de cette baignoire sabot au design superbe et aux dimensions compactes en font le choix idéal pour les petites salles de bains. Découvrez notre gamme de couleurs RAL en finition mate ou brillante. Les pieds en métal sont disponibles en différentes finitions - voir page suivante.

Die perfekten Linien dieser hervorragend konzipierten Slipperwanne und ihre kompakten Abmessungen machen sie besonders attraktiv für kleinere Bäder. Schauen Sie sich das Spektrum der verfügbaren RAL-Farben in glänzender und matter Oberfläche an. Eine Auflistung der verfügbaren Metalloberflächen für die FüÙe finden Sie auf der nächsten Seite.

Le linee perfette di questa vasca da bagno squisitamente progettata e le sue dimensioni compatte la rendono particolarmente adatta ai bagni piÙ piccoli. Disponibile in sei finiture di colori o esplora il nostro spettro di nuovi colori RAL in finiture lucide o opache. E' disponibile una gamma di finiture per piedini in metallo - vedi nella pagina seguente.

De perfecte lijnen van dit prachtig ontworpen slipper bad en zijn compacte afmetingen maken dit model zeer geschikt voor kleinere badkamers - authentieke Victoriaanse stijl voor uw huis. Ontdek ons spectrum van RAL-kleuren in glanzende of matte afwerkingen. Een gamma van afwerkingen van metaal poten zijn beschikbaar (zie volgende blz).

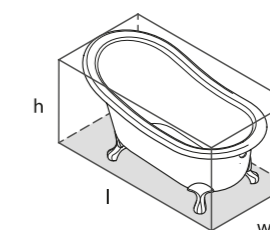

l = 1537mm/60½"
w = 762mm/30"
h = 786mm/31"

○ SHR-N-SW-OF
⬇ PAINT-BATH
53kg



○ SHR-N-SW-OF

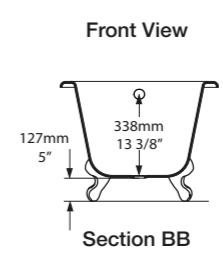
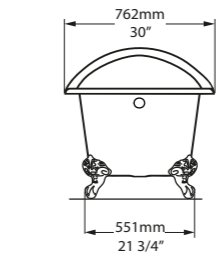
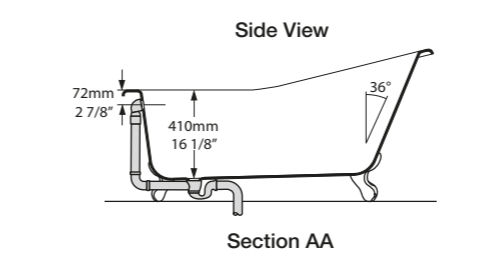
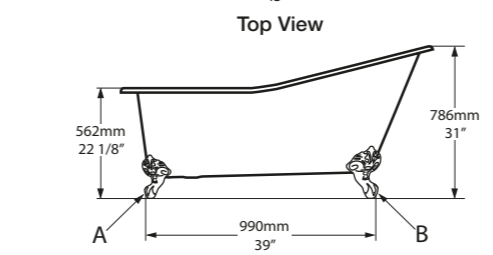
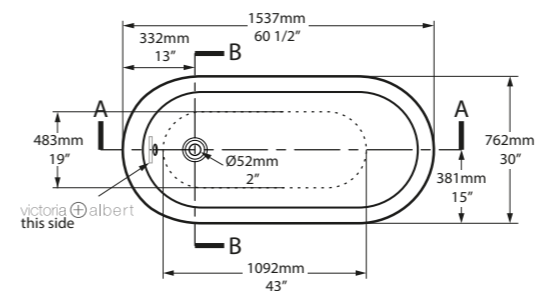

CE UPC Massachusetts Code cUPC listing by IAPMO

Tap holes can be drilled by installer
 Armaturenlöcher können leicht vom Installateur gebohrt werden
 Les trous de robinetterie peuvent être percés par l'installateur
 Pueden ser perforados por el instalador
 I fori per rubinetti possono essere perforati dall'installatore

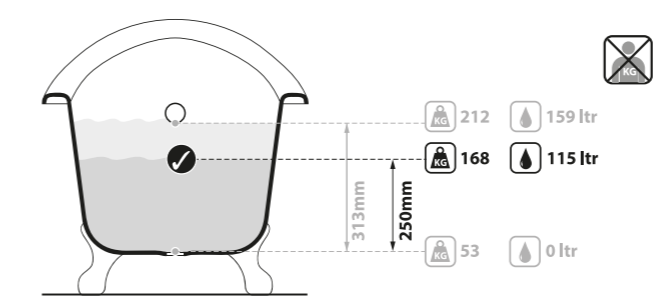
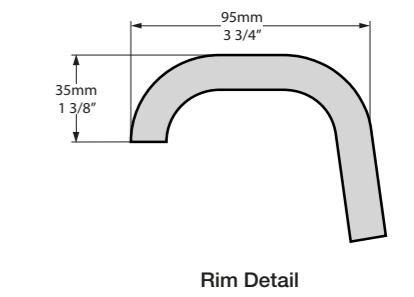
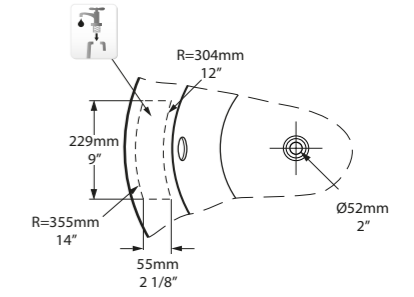

Cornwall, UK

Photography by: Anya Rice

Design by: Tanya Leech



Qc rich in Volcanic Limestone™



SW QUARRYCAST™ Blanc.
 QUARRYCAST™ Weiß.
 QUARRYCAST™ Bianco.
 QUARRYCAST™ Wit.

Qc rich in Volcanic Limestone™

Personalise.
 Personnaliser.
 Personalisieren.
 Aanpassen.



SL D

Taizu est notre première collaboration avec l'architecte de renom Steve Leung, basé à Hong Kong, et qui est connu pour utiliser les influences asiatiques dans ses conceptions.

La baignoire ronde et opulente tire son inspiration des créations en porcelaine fine de la Dynastie Song. Les côtés légèrement inclinés sont adoucis par un bord biseauté et une base sculptée. Avec un diamètre d'environ 1500mm, Taizu est une pièce d'inspiration spa qui s'intègre parfaitement dans les salles de bains les plus luxueuses.

Découvrez notre gamme de couleurs RAL en finition mate ou brillante.

Taizu ist unsere erste Zusammenarbeit mit dem in Hong Kong lebenden Designer Steve Leung. Er ist bekannt für seine Designs mit asiatischem Einfluss.

Die opulente, runde Wanne wurde von den feinen Porzellandesigns der Song Dynastie beeinflusst. Die sanft geneigten Seiten haben einen abgeschrägten Rand und skulpturale Details am Sockel. Mit einem Durchmesser von 1500mm ist die Taizu ein Blickfang im Spa-Stil für die luxuriösesten Badezimmer.

Schauen Sie sich das Spektrum der verfügbaren RAL-Farben in glänzender und matter Oberfläche an.

Taizu è la nostra prima collaborazione con il famoso designer di Hong Kong Steve Leung, noto nell' utilizzare influenze asiatiche nei suoi progetti.

L'opulento vasca circolare è stata ispirata ai raffinati disegni in porcellana della Dinastia Song. I lati leggermente inclinati sono ammorbiditi da un bordo smussato e dettagli scolpiti alla base. Con un diametro di 1500mm, Taizu è un capolavoro in stile spa che è di casa nei bagni più lussuosi.

Esplori la nostra gamma di colori RAL con finiture lucide e opache.

Taizu is onze eerste samenwerking met de beroemde Hongkong-designer Steve Leung, die bekend staat om het gebruik van Aziatische invloeden in zijn ontwerpen.

Het weelderige ronde bad is geïnspireerd op de fijne porseleinen ontwerpen van de Song-dynastie. De zacht hellende zijanten worden verzacht door een afgeschuinde rand en gebeeldhouwde details aan de basis. Met een diameter van 1500mm is Taizu een middelpunt in de stijl van een spa dat thuis is in de meest luxueuze badkamers.

Ontdek ons spectrum van RAL-kleuren in glanzende of matte afwerkingen.

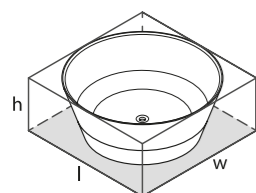

l = 1500mm/59"
w = 1500mm/59"
h = 600mm/23 5/8"

○ TAI-N-SW-NO
PAINT-BATH
95kg





○ TAI-N-SW-NO 

CE  Massachusetts Code cUPC listing by IAPMO

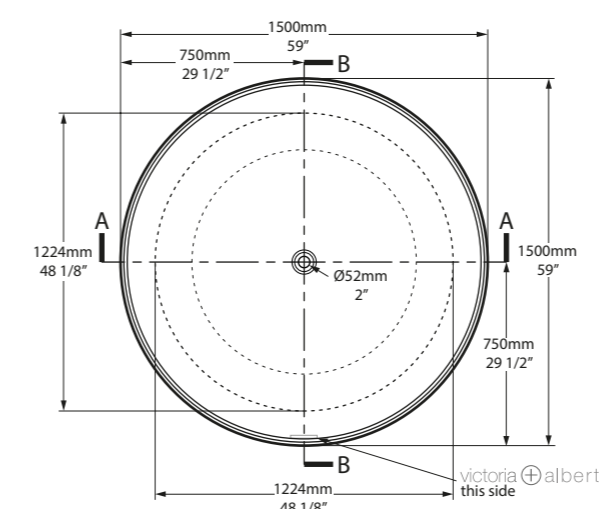

Top View

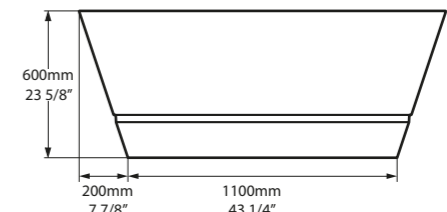

Front View

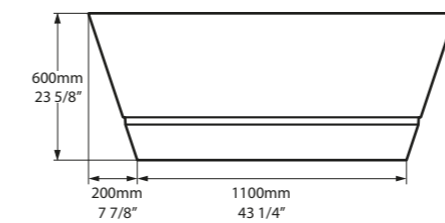

Side View

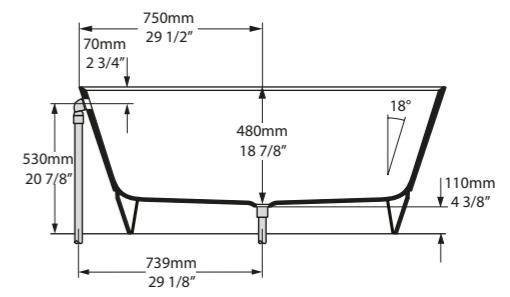

Section AA / Section BB

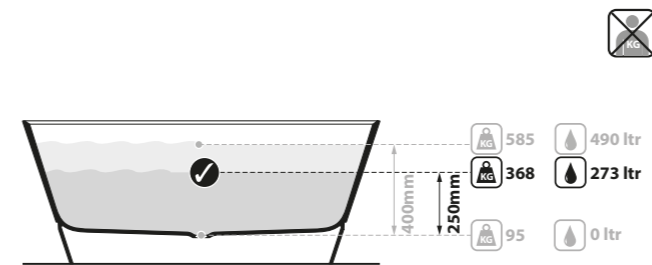

SW

QUARRYCAST™ Blanc.
QUARRYCAST™ Weiß.
QUARRYCAST™ Bianco.
QUARRYCAST™ Wit.

QC rich in volcanic Limestone



Personalise.
Personaliser.
Personalifizieren.
Aanpassen.

Terrassa est une baignoire à double assise avec des détails internes sculptés. Avec seulement 1702mm de long, elle s'adapte parfaitement aux salles de bains contemporaines de toute taille. A associer aux vasques Barcelona 48, Barcelona 55 ou Barcelona 64 (pag 176-181). Découvrez notre gamme de couleurs RAL en finition mate ou brillante.

Die Terrassa ist eine doppelseitige Wanne mit skulpturalen Details an der Innenseite. Mit nur 1702mm Länge passt sie in moderne Badezimmer jeder Größe. Zu kombinieren mit den Waschbecken Barcelona 48, Barcelona 55 oder Barcelona 64 (Seiten 176-181). Schauen Sie sich das Spektrum der verfügbaren RAL-Farben in glänzender und matter Oberfläche an.

La Terrassa è una vasca a doppia seduta con dettagli scolpiti internamente. Con soli 1702mm di lunghezza, è la soluzione perfetta per un bagno contemporaneo di qualsiasi dimensione. Complementata dai lavabi Barcelona 48, Barcelona55 o Barcelona 64 (pagina 176-181). Esplori la nostra gamma di colori RAL con finiture lucide e opache.

De Terrassa is een bad met tweezijdige rugleuningen en aan de binnenzijde een design detail. Met zijn 1702mm lengte, is het de perfecte match voor een moderne badkamer van elke omvang. Ontdek ons spectrum van RAL-kleuren in glanzende of matte afwerkingen.

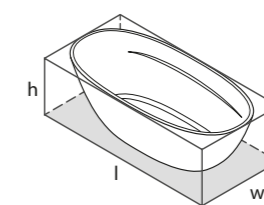

l = 1702mm/67"
w = 793mm/31¼"
h = 528mm/20¾"

○ TER-N-SW-NO
■ PAINT-BATH
74kg



São Paulo, Brazil

Photography by: Isadora Fabian

Design by: Forma 011 Arquitetura + Design



○ TER-N-SW-NO

CE Massachusetts Code cUPC listing by IAPMO

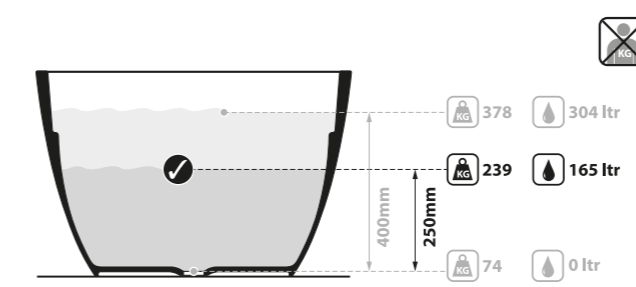
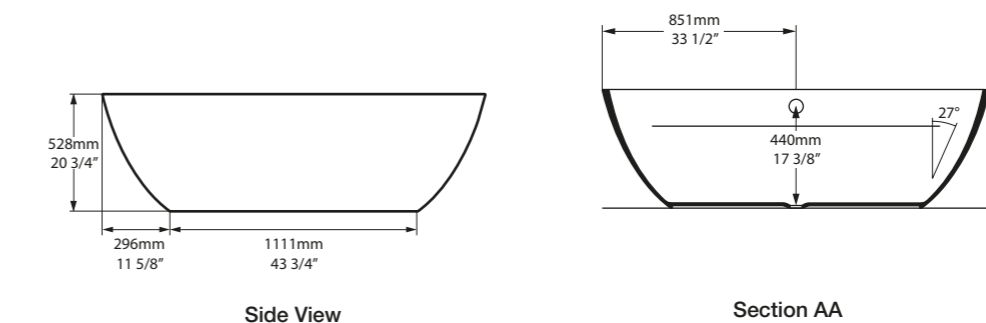
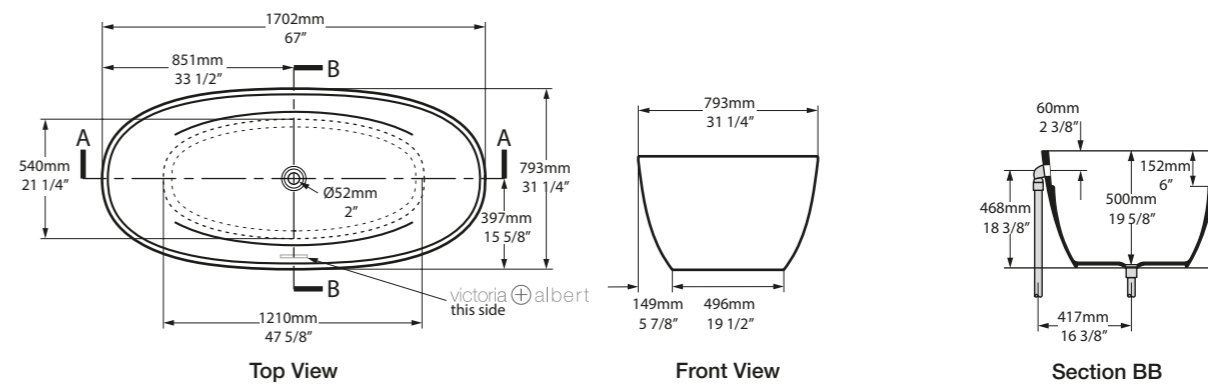

SW QUARRYCAST™ Blanc.
QUARRYCAST™ Weiß.
QUARRYCAST™ Bianco.
QUARRYCAST™ Wit.

QC rich in volcanic Limestone

Personalise.
 Personaliser.
Personalifizieren.
Aanpassen.



Design classique pour Victoria + Albert - une baignoire bateau symétrique inspirée par les modèles français en vogue dans les années 1860. Toulouse est désormais disponible en deux tailles : Toulouse 1500 et Toulouse 1800, donnant une touche classique à n'importe quel espace. Découvrez notre gamme de couleurs RAL en finition mate ou brillante.

Klassisches Design von Victoria + Albert - eine doppelseitige Bateau-Wanne, die auf die französischen Versionen ab den 1860er-Jahren zurückgeht. Die Toulouse ist jetzt in zwei Größen erhältlich. Mit der Toulouse 1500 und der Toulouse 1800 können Sie jetzt in jedem Raum ein klassisches Statement abgeben. Schauen Sie sich das Spektrum der verfügbaren RAL-Farben in glänzender und matter Oberfläche an.

Il design classico della Victoria + Albert a doppia seduta è ispirato alla versione francese vista per la prima volta nel 1860. La Toulouse è un'affermazione dello stile classico, ora disponibile in due dimensioni: Toulouse 1500 e Toulouse 1800. Esplori la nostra gamma di colori RAL con finiture lucide e opache.

Klassiek ontwerp van Victoria + Albert - een dubbelzijdig bateaubad, geïnspireerd op de Franse baden uit de jaren 1860. Toulouse is nu verkrijgbaar in twee maten; Toulouse 1500 en Toulouse 1800, en creëert een klassiek statement in elke ruimte. Ontdek ons spectrum van RAL-kleuren in glanzende of matte afwerkingen.



Toulouse 1500

○ TO1-N-SW-NO  ○ TO1M-N-SM-NO 

CE  Massachusetts Code: Pending
cUPC listing by IAPMO: Pending

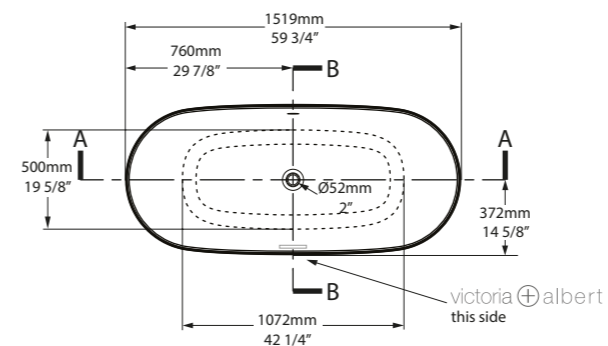

Top View

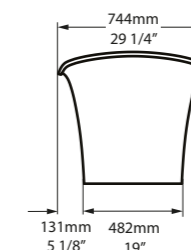

Front View

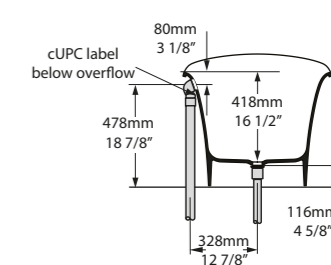

Section BB

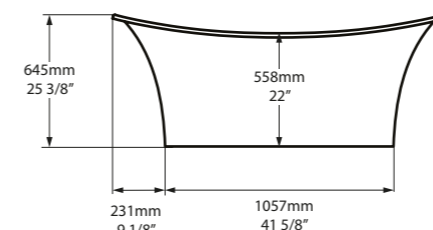

Side View

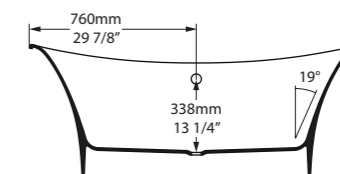

Section AA

La Toulouse 1500 offre toutes les caractéristiques de la baignoire classique Toulouse : un rebord finement ourlé, au design impeccable jusqu'au sol. Toulouse 1500 est idéale pour les petites salles de bains où l'espace est précieux. La baignoire offre aussi un vide sanitaire dans sa partie inférieure pour les tuyaux d'évacuation. Découvrez notre gamme de couleurs RAL en finition mate ou brillante.

Als Neuzugang im Programm bringt die Toulouse 1500 alle Markenzeichen der klassischen Toulouse Wanne mit: einen elegant gerollten Rand und ein nahtlos bis zum Boden reichendes Design. Die Toulouse 1500 eignet sich perfekt für kleinere Badezimmer mit knappem Raumangebot. Ein Hohlraum unterhalb der Wanne verbirgt die Abflussinstallation. Schauen Sie sich das Spektrum der verfügbaren RAL-Farben in glänzender und matter Oberfläche an.

La Toulouse 1500 racchiude tutti i tratti caratteristici della Toulouse classica, un elegante bordo arrotondato, dal design continuo che spinge verso il pavimento. Toulouse 1500 è perfetta per i bagni di piccole dimensioni, dove bisogna valorizzare lo spazio. La vasca vanta inoltre un vano tecnico nella parte inferiore per accogliere i tubi di scarico. Esplori la nostra gamma di colori RAL con finiture lucide e opache.

De Toulouse 1500 heeft alle kenmerken van het klassieke Toulouse-bad; een design met een elegante gekromde rand die naadloos naar de vloer buigt. Toulouse 1500 is perfect voor kleinere badkamers waar de ruimte beperkt is. Het bad is tevens voorzien van een dubbele bodem voor afvoerleidingen. Ontdek ons spectrum van RAL-kleuren in glanzende of matte afwerkingen.

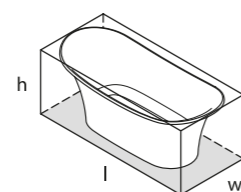

l = 1519mm/59 3/4"
w = 744mm/29 1/4"
h = 647mm/25 1/2"

○ TO1-N-SW-NO
○ TO1M-N-SM-NO
PAINT-BATH
59kg

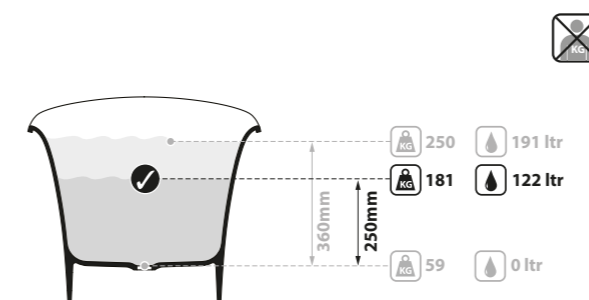

SW QUARRYCAST™ Blanc.
QUARRYCAST™ Weiß.
QUARRYCAST™ Bianco.
QUARRYCAST™ Wit.

SM QUARRYCAST™ Blanc Mat.
QUARRYCAST™ Standard Matt.
QUARRYCAST™ Standard Opaco.
QUARRYCAST™ Standaard Mat.

rich in Volcanic Limestone



Personalise.
Personaliser.
Personalifizieren.
Aanpassen.



Toulouse 1800

○ TOU-N-SW-NO  ◉ TOUM-N-SM-NO 

  Massachusetts Code
cUPC listing by IAPMO

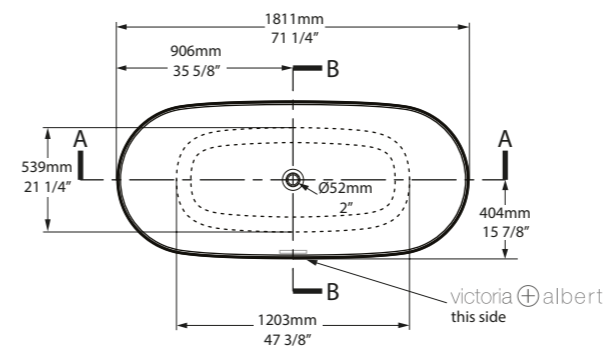

Top View

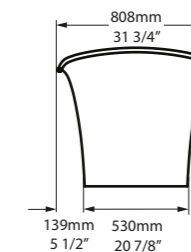

Front View

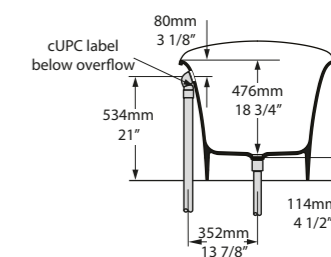

Section BB

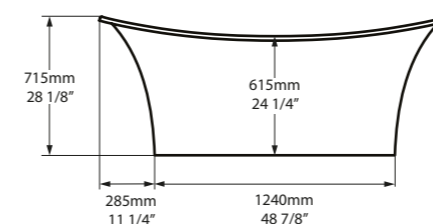

Side View

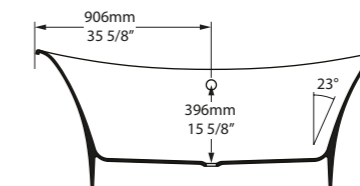

Section AA

Une baignoire profonde aux extrémités délicatement inclinées évoquant la coque d'un bateau, et proposant un support luxueux pour la tête et le cou. La Toulouse 1800 offre aussi un vide sanitaire dans sa partie inférieure pour les tuyaux d'évacuation. Découvrez notre gamme de couleurs RAL en finition mate ou brillante.

Eine tiefe doppelseitige Badewanne im Bateau-Stil mit luxuriöser Kopf- und Nackenstütze. Ein Hohlraum unterhalb der Toulouse 1800 verbirgt die Abflussinstallation. Schauen Sie sich das Spektrum der verfügbaren RAL-Farben in glänzender und matter Oberfläche an.

Una vasca profonda e doppia al tempo stesso, in stile "bateau" che vanta un lussuoso supporto sia per la testa che per il collo. La Toulouse 1800 vanta inoltre un vano tecnico nella parte inferiore per accogliere i tubi di scarico. Esplori la nostra gamma di colori RAL con finiture lucide e opache.

Een diep bad in bateau -stijl met aan beide kanten een luxe hoofd- en neksteun. De Toulouse 1800 heeft een dubbele bodem voor afvoerleidingen. Ontdek ons spectrum van RAL-kleuren in glanzende of matte afwerkingen.

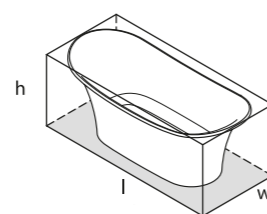

l = 1811mm/71 1/4"
w = 808mm/31 3/4"
h = 715mm/28 1/4"

○ TOU-N-SW-NO
◉ TOUM-N-SM-NO
PAINT-BATH
69kg

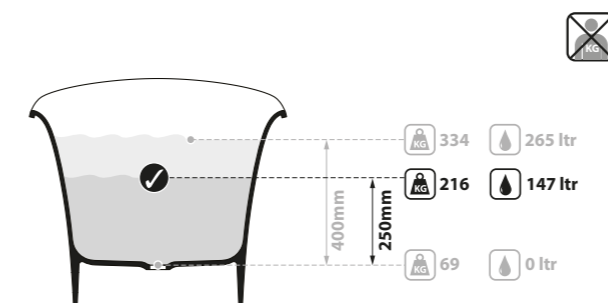

SW

QUARRYCAST™ Blanc.
QUARRYCAST™ Weiß.
QUARRYCAST™ Bianco.
QUARRYCAST™ Wit.

SM

QUARRYCAST™ Blanc Mat.
QUARRYCAST™ Standard Matt.
QUARRYCAST™ Standard Opaco.
QUARRYCAST™ Standaard Mat.

rich in
Volcanic
Limestone



Personalise.
Personaliser.
Personalifizieren.
Aanpassen.

Une réinvention moderne de la baignoire bateau classique. Profonde et à double assise, disposant d'un fin rebord, Trivento s'intègre aussi bien dans les appartements en ville que dans les salles de bains familiales. Découvrez notre gamme de couleurs RAL en finition mate ou brillante.

Eine moderne Version der klassischen Bateau Wanne. Mit schmalen Rand, doppelseitig und großzügiger Eintauchtiefe ist die Trivento in kleineren Wohnungen ebenso passend wie in großen Familienbadezimmern. Schauen Sie sich das Spektrum der verfügbaren RAL-Farben in glänzender und matter Oberfläche an.

Una moderna reinvenzione della classica vasca bateau. Caratterizzata da un bel e profondo bordo a doppia seduta, Trivento è ugualmente a casa in appartamenti di città o stanze da bagno per famiglie. Esplori la nostra gamma di colori RAL con finiture lucide e opache.

Een modern versie van het klassieke bateau bad. Het Trivento bad biedt diepte, een dubbele rugleuning en elegante randen. Past prima in appartementen of familie badkamers. Ontdek ons spectrum van RAL-kleuren in glanzende of matte afwerkingen.

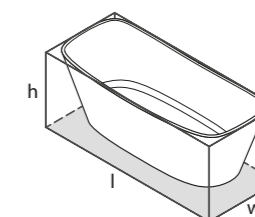

l = 1650mm/65"
w = 707mm/27 7/8"
h = 580mm/22 7/8"

○ TRV-N-SW-NO
■ PAINT-BATH
70kg



○ TRV-N-SW-NO 

CE  Massachusetts Code cUPC listing by IAPMO

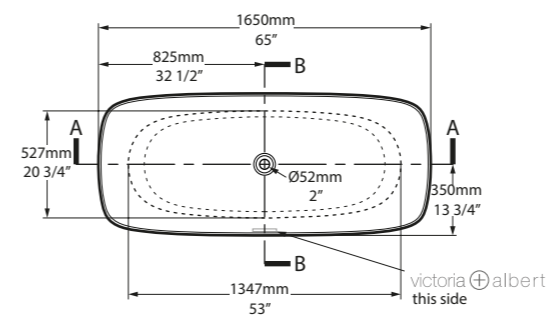

Top View

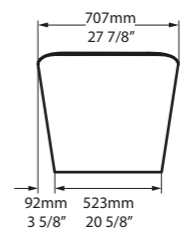

Front View

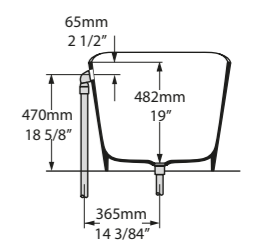

Section BB

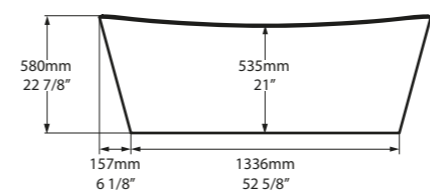

Side View

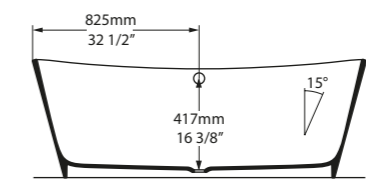

Section AA

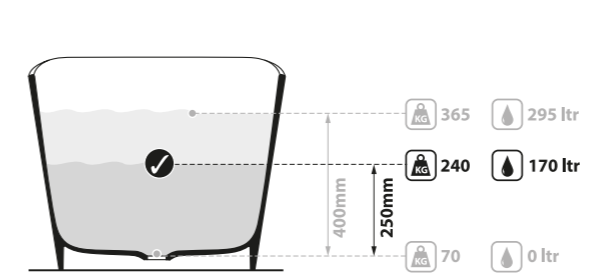

Houston, Texas, USA

Photography by: Nathan Schroder
Design by: Talbot Cooley Interiors



QUARRYCAST™ Blanc.
QUARRYCAST™ Weiß.
QUARRYCAST™ Bianco.
QUARRYCAST™ Wit.



Personalise.
Personaliser.
Personalisieren.
Aanpassen.



Vetralla collection

Grâce à des lignes simples et son design symétrique, la collection Vetralla est idéale pour les salles de bains modernes où l'espace est précieux. Vetralla est disponible en deux tailles, Vetralla 1500 et Vetralla 1650.

Mit ihren einfachen Linien und dem tiefen, doppelseitigen Design eignet sich die Vetralla Kollektion ideal für moderne Badezimmer mit knappem Raumangebot. Die Vetralla ist in zwei Größen erhältlich, Vetralla 1500 und Vetralla 1650.

Con le sue semplici linee e un design profondo a doppia seduta, la collezione Vetralla è la soluzione ideale per i bagni moderni dove bisogna valorizzare lo spazio. Vetralla è disponibile in due dimensioni, Vetralla 1500 e Vetralla 1650.

De eenvoudige lijnen en het diepe, dubbelzijdige design maken de Vetralla-collectie ideaal voor moderne badkamers waarin ruimte schaars is. Vetralla wordt aangeboden in twee maten, Vetralla 1500 en Vetralla 1650.



Vetralla 1500

○ VET-N-SW-NO  ◉ VETM-N-SM-NO 

CE  Massachusetts Code
cUPC listing by IAPMO

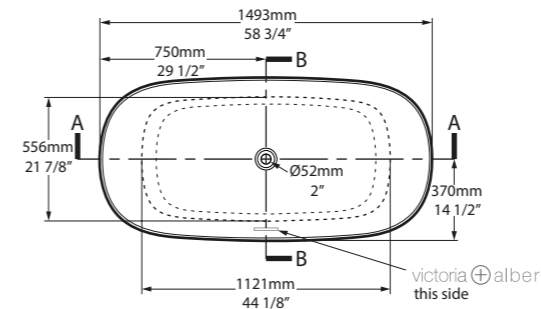

Top View

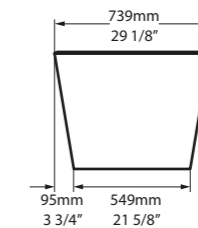

Front View

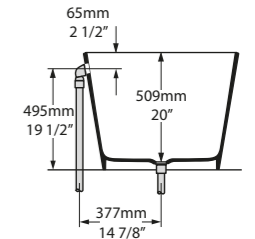

Section BB

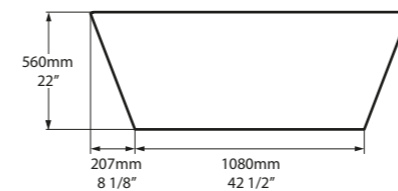

Side View

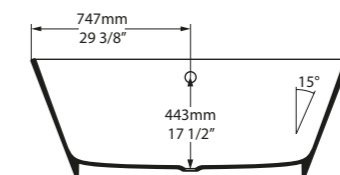

Section AA

La plus petite des deux baignoires Vetralla, le modèle Vetralla 1500 est une pièce maîtresse unique pour les petites salles de bains, un espace habituellement réservé à une baignoire encastrée. Découvrez notre gamme de couleurs RAL en finition mate ou brillante.

Als die kleinere der beiden Vetralla Wannen ist die Vetralla 1500 ein einzigartiges Kernelement für kleinere Badezimmer. Sie belegt nicht mehr Stellfläche als eine normale Einbauwanne. Schauen Sie sich das Spektrum der verfügbaren RAL-Farben in glänzender und matter Oberfläche an.

La più piccola delle nostre vasche da bagno Vetralla, la Vetralla 1500 è il pezzo forte di un bagno anche di piccole dimensioni, liberando lo spazio che solitamente sarebbe destinato a un vasca da incasso. Esplori la nostra gamma di colori RAL con finiture lucide e opache.

Als de kleinste van onze twee Vetralla-baden is de Vetralla 1500 een uniek middelpunt voor de kleinere badkamer, waar men anders voor een inbouwbad zou moeten kiezen. Ontdek ons spectrum van RAL-kleuren in glanzende of matte afwerkingen.

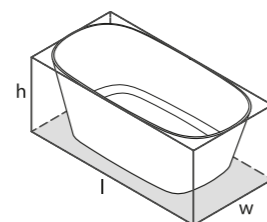

l = 1493mm/58 3/4"
w = 739mm/29 1/8"
h = 560mm/22"

○ VET-N-SW-NO
◉ VETM-N-SM-NO
 PAINT-BATH
64kg

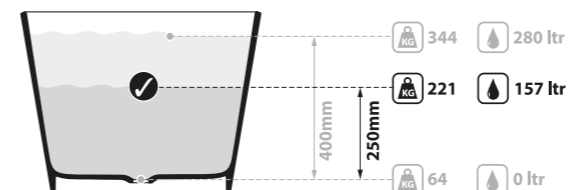

SW

QUARRYCAST™ Blanc.
QUARRYCAST™ Weiß.
QUARRYCAST™ Bianco.
QUARRYCAST™ Wit.

SM

QUARRYCAST™ Blanc Mat.
QUARRYCAST™ Standard Matt.
QUARRYCAST™ Standard Opaco.
QUARRYCAST™ Standaard Mat.



QC rich in Volcanic Limestone



Personalise.
Personaliser.
Personalifizieren.
Aanpassen.



Vetralla 1650

○ VE2-N-SW-NO  ○ SM VE2M-N-SM-NO 

CE  Massachusetts Code cUPC listing by IAPMO

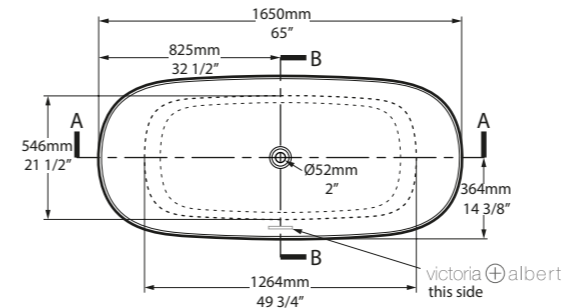

Top View

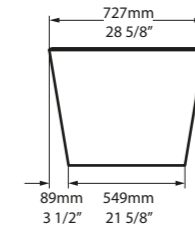

Front View

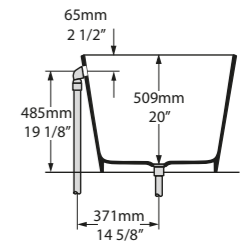

Section BB

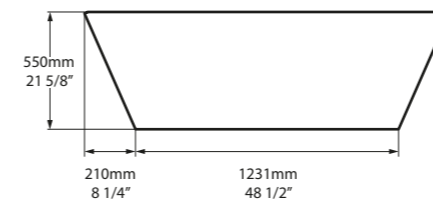

Side View

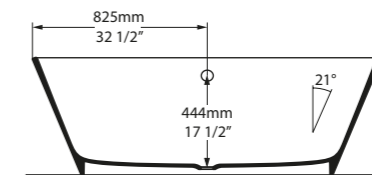

Section AA

Vetralla 1650 est profonde, symétrique et offre un volume généreux. Également proposé dans un format plus petit appelé Vetralla 1500. Découvrez notre gamme de couleurs RAL en finition mate ou brillante.

Die Vetralla 1650 ist tief und doppelseitig und bietet ein großzügiges Volumen. Als Vetralla 1500 ist sie in einem kleineren Format erhältlich. Schauen Sie sich das Spektrum der verfügbaren RAL-Farben in glänzender und matter Oberfläche an.

Vetralla 1650 è profonda e a doppia seduta, e offre un volume generoso. È disponibile anche in un formato ridotto, Vetralla 1500. Esplori la nostra gamma di colori RAL con finiture lucide e opache.

Vetralla 1650 is diep en is dubbelzijdig, met een royaal volume. Ook verkrijgbaar in een kleiner formaat, Vetralla 1500. Ontdek ons spectrum van RAL-kleuren in glanzende of matte afwerkingen.

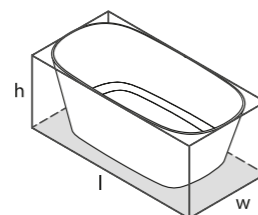

l = 1650mm/65"
w = 727mm/28 5/8"
h = 550mm/21 5/8"

○ VE2-N-SW-NO
○ SM VE2M-N-SM-NO
PAINT-BATH
69kg

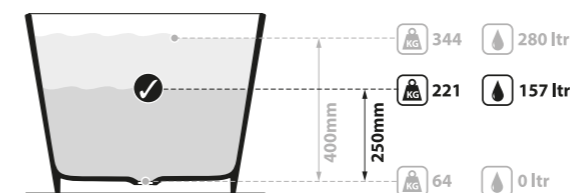

SW QUARRYCAST™ Blanc.
QUARRYCAST™ Weiß.
QUARRYCAST™ Bianco.
QUARRYCAST™ Wit.

SM QUARRYCAST™ Blanc Mat.
QUARRYCAST™ Standard Matt.
QUARRYCAST™ Standard Opaco.
QUARRYCAST™ Standaard Mat.

QC rich in Volcanic Limestone



Personalise.
Personaliser.
Personalisieren.
Aanpassen.

La baignoire Warndon, avec ses rebords côtelés classiques, reprend les détails que l'on trouvait déjà dans le travail de la pierre classique. Cette baignoire mélange design classique avec des lignes modernes et élégantes. Dispose d'un vide sanitaire pour le raccordement du système d'évacuation. Découvrez notre gamme de couleurs RAL en finition mate ou brillante.

Die Warndon besitzt einen klassisch geriffelten Rand, der originale Details von Steinmetzarbeiten aufgreift. Diese Wanne verbindet klassische Merkmale mit eleganten, modernen Linien. Mit einem unten liegenden Hohlraum für die Abflussrohre. Schauen Sie sich das Spektrum der verfügbaren RAL-Farben in glänzender und matter Oberfläche an.

La Warndon presenta un bordo a coste in stile classico, adottando i dettagli originariamente trovati in muratura classica. Questa vasca fonde elementi classici con linee eleganti e moderne. Caratterizzata da uno spazio sotto per l'impianto di scarico. Esplori la nostra gamma di colori RAL con finiture lucide e opache.

De Warndon is voorzien van een klassiek geribbelde rand, welke zijn oorsprong vindt in klassieke metselwerk. Dit bad combineert klassieke elementen met elegante, moderne lijnen. Beschikt over een dubbele bodem voor eenvoudige installatie van leidingwerk. Ontdek ons spectrum van RAL-kleuren in glanzende of matte afwerkingen.

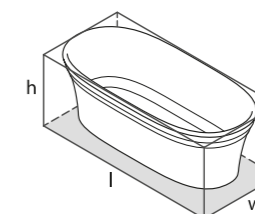

l = 1702mm/67"
w = 801mm/31½"
h = 598mm/23½"

○ WAR-N-SW-NO
👤 PAINT-BATH
85kg



Kew Gardens, London, UK

Photography by: Megan Taylor

Design by: 2LG Studio



Warndon

○ WAR-N-SW-NO 

CE  Massachusetts Code
cUPC listing by IAPMO

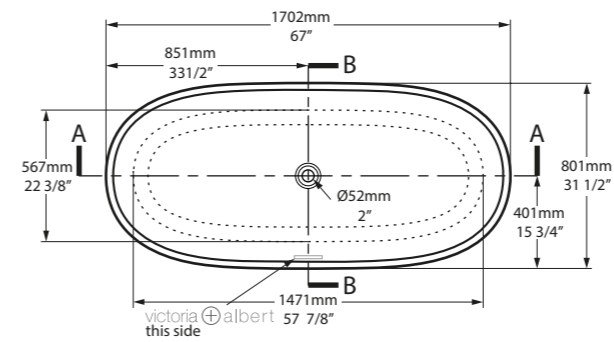

Top View

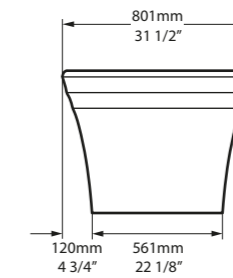

Front View

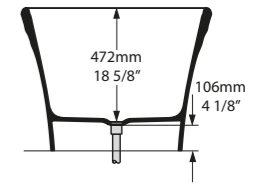

Section BB

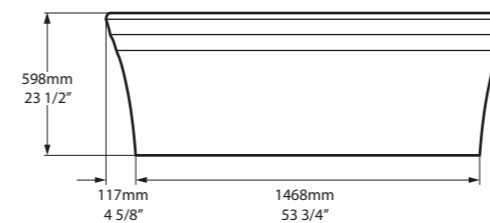

Side View

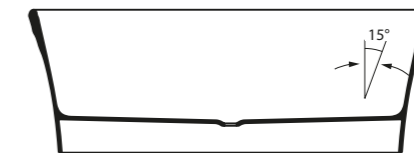

Section AA

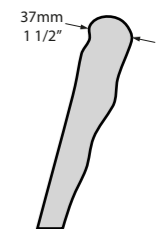

Rim Detail

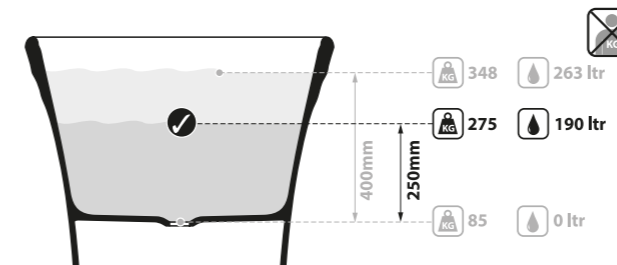

SW
 QUARRYCAST™ Blanc.
 QUARRYCAST™ Weiß.
 QUARRYCAST™ Bianco.
 QUARRYCAST™ Wit.

QC rich in volcanic Limestone



Personalise.
 Personaliser.
 Personalifizieren.
 Aanpassen.





Avec ses lignes classiques et ses dimensions réduites, cette baignoire à l'élégance Edwardienne exquise est idéale pour les petites salles de bains. Découvrez notre gamme de couleurs RAL en finition mate ou brillante. Les pieds en métal sont disponibles en différentes finitions - voir page suivante.

Mit klassischen Linien und abgespeckten Maßen. Der hervorragende Edwardianische Stil passt besonders in kompakte Badezimmer. Schauen Sie sich das Spektrum der verfügbaren RAL-Farben in glänzender und matter Oberfläche an. Eine Auflistung der verfügbaren Metalloberflächen für die Füße finden Sie auf der nächsten Seite.

Caratterizzata da linee classiche di dimensioni rimpicciolite. Uno stile Edwardiano squisito che si adatta ovunque. Esplori la nostra gamma di colori RAL con finiture lucide e opache. E' disponibile una gamma di finiture per piedini in metallo - vedi nella pagina seguente.

Klassieke lijnen en afgeslankte afmetingen. Exquisite Edwardian stijl die past in compact badkamers. Ontdek ons spectrum van RAL-kleuren in glanzende of matte afwerkingen. Een gamma van afwerkingen van metaal poten zijn beschikbaar (zie volgende blz).

Collections connexes / Entsprechendes Zubehör / Collezioni correlate / Gerelateerde collecties

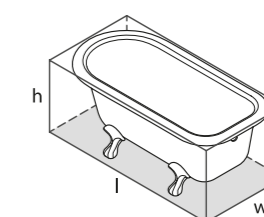

l = 1525mm/60"
w = 761mm/30"
h = 613mm/24½"

○ WES-N-SW-OF
■ PAINT-BATH
63kg

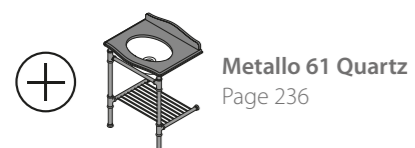



○ WES-N-SW-OF

CE Massachusetts Code cUPC listing by IAPMO

Tap holes can be drilled by installer
 Armaturenlöcher können leicht vom Installateur gebohrt werden
 Les trous de robinetterie peuvent être percés par l'installateur
 Pueden ser perforados por el instalador
 I fori per rubinetti possono essere perforati dall'installatore

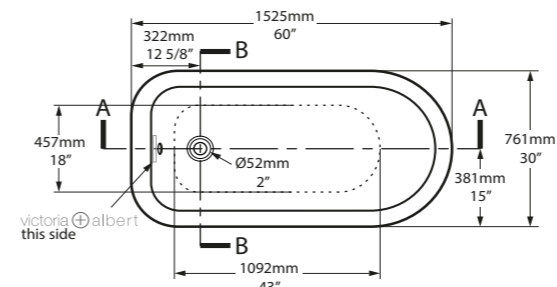

Top View

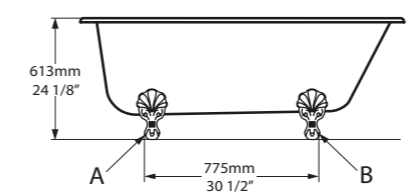

Section AA

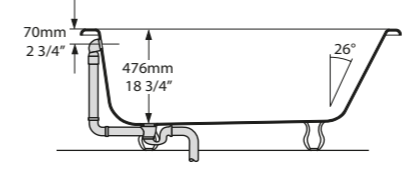

Section BB

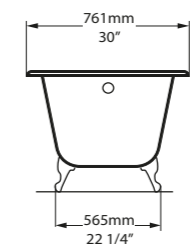

Section BB

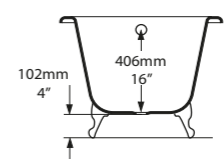

Rim Detail

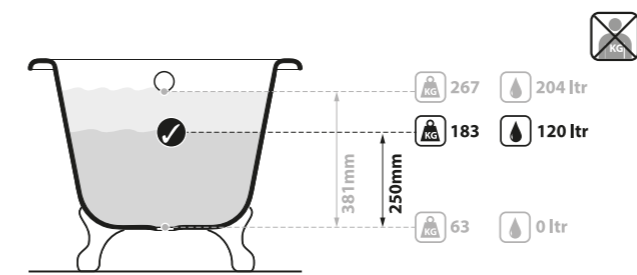
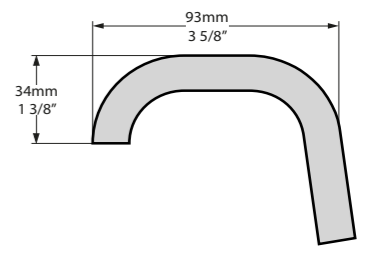
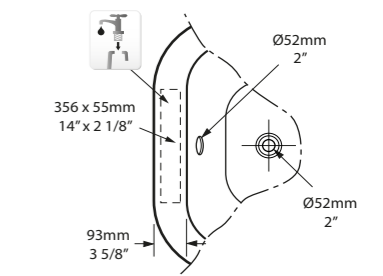

São Paulo, Brazil

Photography by: Ronaldo Rizzutti

Architecture: Andrea Murao



rich in Volcanic Limestone™

QUARRYCAST™ Blanc.
 QUARRYCAST™ Weiß.
 QUARRYCAST™ Bianco.
 QUARRYCAST™ Wit.

rich in Volcanic Limestone™

Personalise.
 Personnaliser.
 Personalifizieren.
 Aanpassen.



Élégante, classique et raffinée. La Worcester tire son nom de la ville anglaise réputée pour sa cathédrale et de la ville sud-africaine où se trouve l'usine Victoria + Albert. Avec son socle côtelé classique et la finition de ses rebords qui trouvent leur origine dans le travail de la pierre, elle incarne une histoire riche adaptée à de nombreux intérieurs. Dispose d'un vide sanitaire pour le raccordement du système d'évacuation. Découvrez notre gamme de couleurs RAL en finition mate ou brillante.

Elegant, klassisch und kultiviert: Namensgeber der Worcester Wanne ist die alte, englische Stadt mit der berühmten Kathedrale sowie die südafrikanischen Stadt, in der die Victoria + Albert Manufaktur sitzt. Mit dem geriffelten Sockel und den klassischen Steinmetzarbeiten nachempfundenen Randdetails verkörpert sie historische Pracht, die sich in unterschiedliche Raumgestaltungen einfügt. Mit einem unten liegenden Hohlraum für die Abflussrohre. Schauen Sie sich das Spektrum der verfügbaren RAL-Farben in glänzender und matter Oberfläche an..

Elegante, classica e raffinata. La vasca Worcester prende il nome sia dall'antica cattedrale Inglese sia dalla città sudafricana dove è situato lo stabilimento di Victoria + Albert. Dotata di una base a coste in stile classico e dettagli del bordo presenti originariamente nei lavori in muratura, sposa una storia molto ricca che si adatta facilmente a diversi ambienti. Esplori la nostra gamma di colori RAL con finiture lucide e opache.

Elegant, klassiek en verfijnd. De Worcester ontleent zijn naam aan de oude Zuid-Afrikaanse stad met haar beroemde cathedraal waar de Victoria + Albert fabriek gevestigd is. Met een klassiek geribbelde plint en een rand detaillering omvat het een rijke geschiedenis, geschikt voor vele interieurs. Beschikt over een dubbele bodem voor eenvoudige installatie van leidingwerk. Ontdek ons spectrum van RAL-kleuren in glanzende of matte afwerkingen.

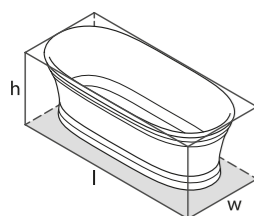

l = 1797mm/70¾"
w = 780mm/30¾"
h = 608mm/23⅞"

○ WOR-N-SW-NO
PAINT-BATH
105kg





○ WOR-N-SW-NO 

CE  Massachusetts Code
cUPC listing by IAPMO

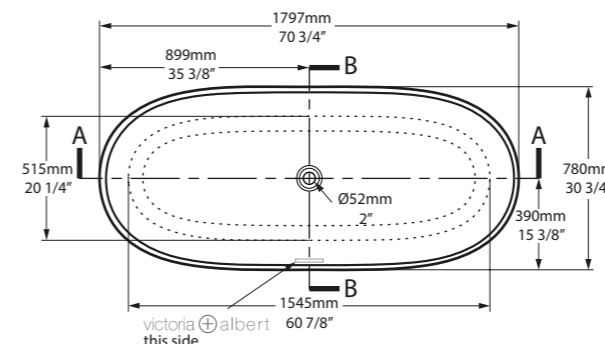

Top View

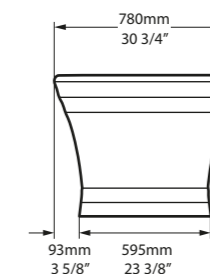

Front View

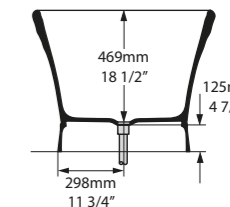

Section BB

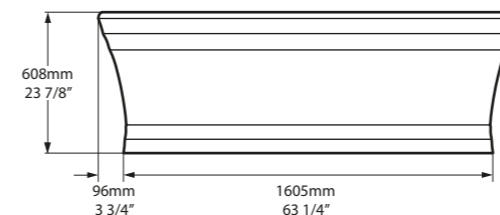

Side View

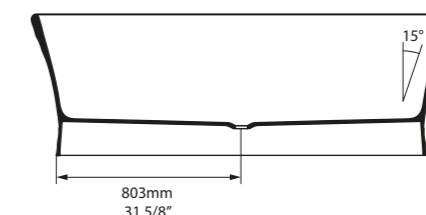

Section AA

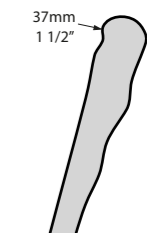

Rim Detail

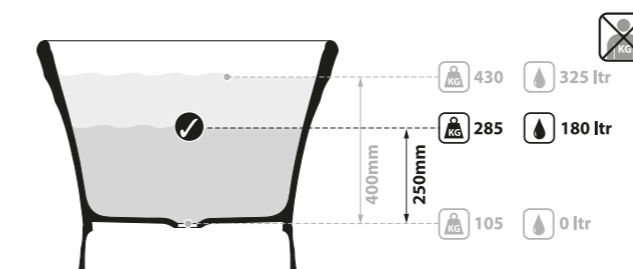

Sydney, New South Wales, Australia

Photography by: Katherine Lu

Design by: Higginbotham Studio



SW
QUARRYCAST™ Blanc.
QUARRYCAST™ Weiß.
QUARRYCAST™ Bianco.
QUARRYCAST™ Wit.

QC  rich in volcanic limestone



Personalise.
Personaliser.
Personalisieren.
Aanpassen.

Avec sa profondeur généreuse la baignoire à double dossier d'inspiration victorienne York, dispose d'un élégant socle permettant de dissimuler le système d'évacuation. Explora nuestra gama de colores RAL en acabados brillante o mate.

Das vom viktorianischen Stil inspirierte Modell York, mit tiefer und doppelseitiger Rückenlehne, ist einfach zu platzieren - der elegante Sockel verbirgt alle Abflußrohre. Schauen Sie sich das Spektrum der verfügbaren RAL-Farben in glänzender und matter Oberfläche an.

Caratterizzata da una profonda seduta con doppio schienale, la vasca York ha il pregio di possedere una base elegante che allo stesso tempo nasconde i sistemi di scarico. Esplori la nostra gamma di colori RAL con finiture lucide e opache.

Met een diepe, dubbelzijdige ruimte biedt de op Victoriaanse style gebaseerde York een sokkel waar de afvoer verborgen blijft. Ontdek ons spectrum van RAL-kleuren in glanzende of matte afwerkingen.

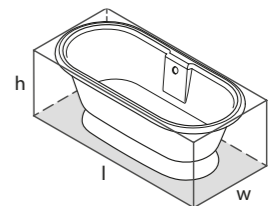

l = 1741mm/68½"
w = 795mm/31¼"
h = 616mm/24¼"

○ YOR-N-SW-OF + YOR-B-SW
🔧 PAINT-BATH
67kg

Collections connexes / Entsprechendes Zubehör / Collezioni correlate / Gerelateerde collecties

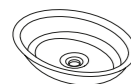

Radford 51
Page 196



○ YOR-N-SW-OF + YOR-B-SW 

CE  Massachusetts Code
cUPC listing by IAPMO

 Tap holes can be drilled by installer
Armaturenlöcher können leicht vom Installateur gebohrt werden
Les trous de robinetterie peuvent être percés par l'installateur
Pueden ser perforados por el instalador
I fori per rubinetti possono essere perforati dall'installatore

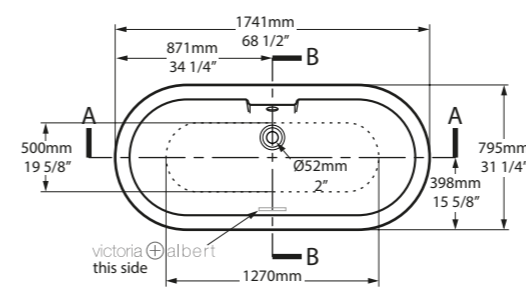

Top View

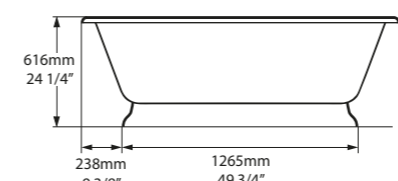

Side View

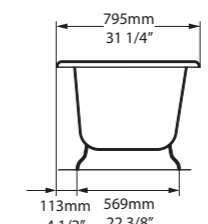

Front View

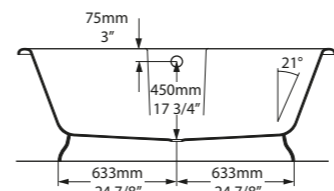

Section AA

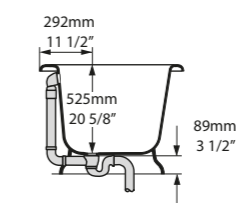

Section BB

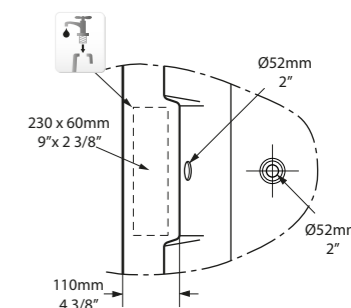

Rim Detail

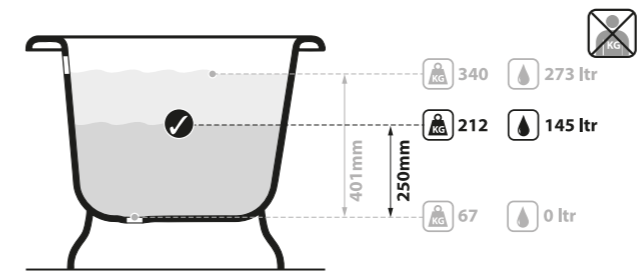

London, UK



Photography by: Kasia Fiszler

Design by: Jess Hurrell



SW QUARRYCAST™ Blanc.
QUARRYCAST™ Weiß.
QUARRYCAST™ Bianco.
QUARRYCAST™ Wit.

Qc rich in
Volcanic
Limestone

 Personalise.
 Personnaliser.
Personalifizieren.
Aanpassen.



Built-in baths

Nos baignoires à encastrer ont été conçues de manière à offrir tous les avantages de notre matériau exclusif, l'QUARRYCAST™, dans un format qui facilite l'installation par encastrement/sous plan ou en alcôve.

Unsere intelligent durchdachten Einbauwannen bieten alle Vorteile unseres einzigartigen QUARRYCAST™ Materials. Sie sind sowohl zur Aufsatzmontage geeignet, als auch zum Unterbau sowie für den Einbau innerhalb einer Nische.

Le nostre vasche da bagno sono state concepite in modo intelligente, offrendo tutti i vantaggi del nostro esclusivo materiale QUARRYCAST™ in un pacchetto che semplifica l'installazione a incasso o alcova.

Onze inbouw baden zijn ontworpen om alle voordelen van ons unieke QUARRYCAST™ - materiaal te leveren wat de installatie voor inbouw of onderbouw eenvoudig maakt.

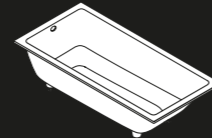
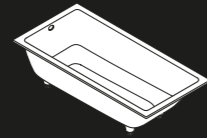
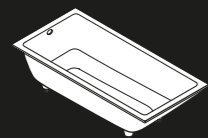

Kaldera 4
1500 x 750
Page 164

Kaldera 5
1500 x 800
Page 166

Kaldera 6
1650 x 900
Page 168

Drop-in	✓	✓	✓
Undermount	✓	✓	✓

Drop-in / Encastrement par dessus / Aufsatz / Ad incasso / Inbouw.

Undermount / Encastrement par dessous / Unterbau / Sottopiano / Onderbouw.



Kaldera 4



○ KAL4-N-SW-OF

CE  Massachusetts Code cUPC listing by IAPMO

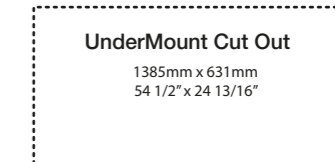
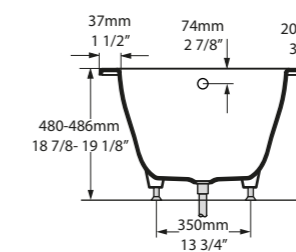
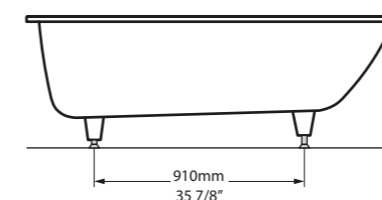
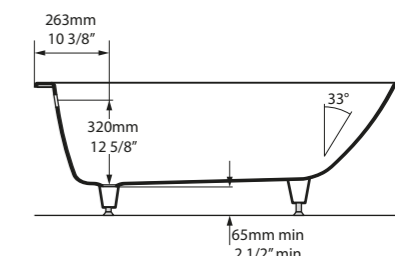
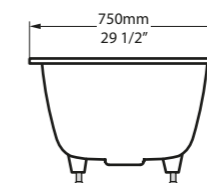
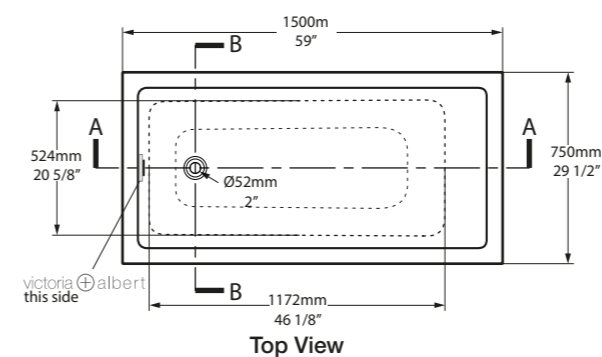

Avec sa conception ergonomique, la Kaldera 4 offre un confort optimal et convient aussi bien aux installations encastrées que sous plan. Ses lignes épurées et son aspect luxueux en font la baignoire idéale aussi bien pour les salles de bains d'hôtels que de résidences privées. Avec des dimensions compactes de 1500mm, elle est parfaite pour les petits espaces.

- Inclinaison à 32°;
- Bords découpés avec précision - idéal pour les installations contre un mur ou en angle;
- Quatre pieds réglables pour un parfait nivellement.

Voir également la baignoire Kaldera 5, qui est plus large, ou la Kaldera 6, qui est quant à elle plus longue.

Kaldera 4 wurde ergonomisch design't und ist geeignet zur Aufsatzmontage oder für den Einbau mit versenktem Rand. Kaldera 4 bringt klare Formen und luxuriösen Stil ins Badezimmer und eignet sich sowohl für den Einsatz im Privatbereich, als auch für den Einsatz in Hotels. Mit ihren kompakten 1500 Millimetern ist sie die ideale Wahl für kleinere Badezimmer.

- Neigungswinkel 32 Grad;
- Rand mit akkuratem Diamantschnitt, ideal für die Wand- sowie die Eckmontage;
- 4 verstellbare Füße für einen perfekten Stand.

Beachten Sie auch die Kaldera 5, die etwas breiter ist sowie die längere Kaldera 6.

Kaldera 4 è progettata ergonomicamente per il massimo comfort e adatta per installazioni ad incasso o montate sotto. Kaldera 4 reagala al bagno linee pulite e uno stile lussuoso, prestandosi sia alle applicazioni per il bagno residenziale che a quelle alberghiere. Misurando un compatto 1500mm, è ideale per spazi più piccoli.

- Angolo di inclinazione di 32°;
- Bordo diamantato accurato - ideale per installazioni a parete o ad angolo;
- Quattro piedini regolabili per un perfetto livellamento.

Vedi anche Kaldera 5, che è più larga, o la più lunga Kaldera 6.

Kaldera 4 is ergonomisch ontworpen voor maximaal comfort en geschikt voor zowel inbouw- als onderbouwinstallaties. Kaldera 4 brengt strakke lijnen en luxe stijl naar de badkamer en leent zichzelf voor toepassingen in zowel woningen als hotels. Met een compacte 1500mm is het ideaal voor kleinere ruimtes.

- Een rugleuning van 32°;
- Nauwkeurige diamantgeneden kanten - ideaal voor tegen-de-muur of hoekinstallaties;
- Vier verstelbare poten voor perfecte nivellering.

Zie ook Kaldera 5, die breder is, of de langere Kaldera 6.

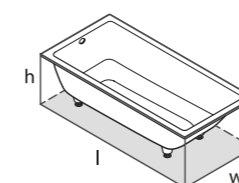
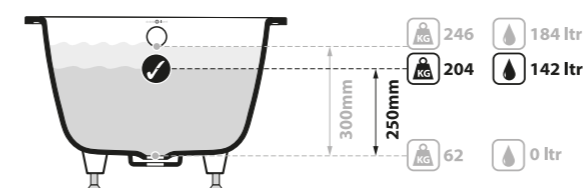

l = 1500mm/59"
w = 750mm/29 1/2"
h = 480-486mm/18 7/8-19 1/8"

○ KAL4-N-SW-OF
62kg



SW
QUARRYCAST™ Blanc.
QUARRYCAST™ Weiß.
QUARRYCAST™ Bianco.
QUARRYCAST™ Wit.

rich in
Volcanic
Limestone



○ KAL5-N-SW-OF

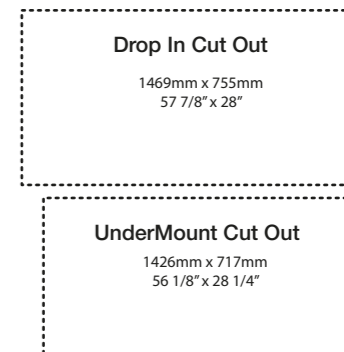
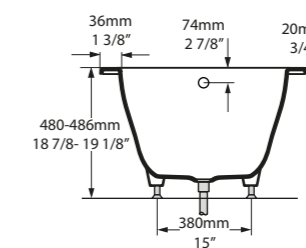
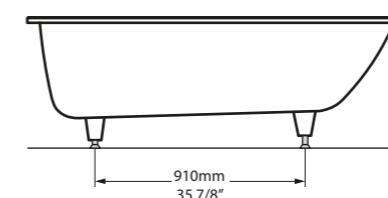
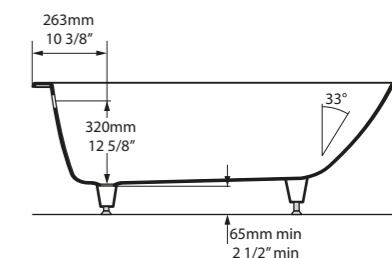
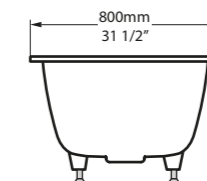
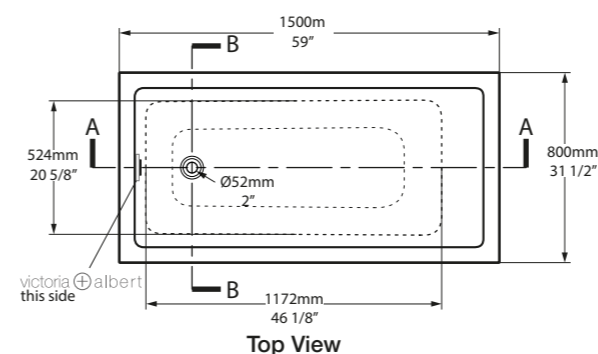

Avec sa conception ergonomique, la Kaldera 5 offre un confort optimal et convient aussi bien aux installations encastrées que sous plan. Ses lignes épurées et son aspect luxueux en font la baignoire idéale aussi bien pour les salles de bains d'hôtels que de résidences privées. Avec des dimensions compactes de 1500mm, elle est parfaite pour les petits espaces.

- Inclinaison à 32°;
- Bords découpés avec précision - idéal pour les installations contre un mur ou en angle;
- Quatre pieds réglables pour un parfait nivellement.

Voir également la baignoire Kaldera 4, qui est plus étroite, ou la Kaldera 6, qui est quant à elle plus longue.

Kaldera 5 wurde ergonomisch design und ist geeignet zur Aufsatzmontage oder für den Einbau mit versenktem Rand. Kaldera 5 bringt klare Formen und luxuriösen Stil ins Badezimmer und eignet sich sowohl für den Einsatz im Privatbereich, als auch für den Einsatz in Hotels. Mit ihren kompakten 1500 Millimetern ist sie die ideale Wahl für kleinere Badezimmer.

- Neigungswinkel 32 Grad;
- Rand mit akkuratem Diamantschnitt, ideal für die Wand- sowie die Eckmontage;
- 4 verstellbare Füße für einen perfekten Stand.

Beachten Sie auch die schmalere Kaldera 4 sowie die längere Kaldera 6.

Kaldera 5 è progettata ergonomicamente per il massimo comfort e adatta per installazioni ad incasso o montate sotto. Kaldera 5 regala al bagno linee pulite e stile lussuoso, prestandosi sia ad applicazioni residenziali che ad hotel. Misurando un compatto 1500mm, è ideale per spazi più piccoli.

- Angolo di inclinazione di 32°;
 - Bordo diamantato - ideale per installazioni a parete o ad angolo;
 - Quattro piedini regolabili per un perfetto livellamento.
- Vedi anche la Kaldera 4, che è più stretta, o la più lunga Kaldera 6.

Kaldera 5 is ergonomisch ontworpen voor maximaal comfort en geschikt voor zowel inbouw- als onderbouwinstallaties. Kaldera 5 brengt strakke lijnen en luxe stijl naar de badkamer en leent zichzelf voor toepassingen in zowel woningen als hotels. Met een compacte 1500mm is het ideaal voor kleinere ruimtes.

- Een rugleuning van 32°;
- Nauwkeurige diamantgeneden kanten - ideaal voor tegen-de-muur of hoekinstallaties;
- Vier verstelbare poten voor perfecte nivellering.

Zie ook Kaldera 4, die smaller is, of de langere Kaldera 6.

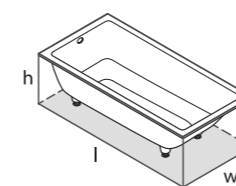
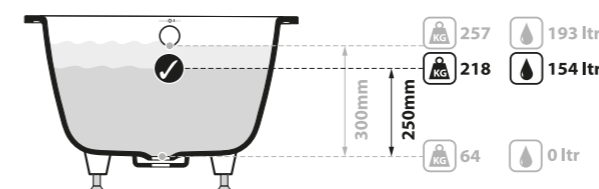

l = 1500mm/59"
w = 800mm/31 1/2"
h = 480-486mm/18 7/8-19 1/8"

○ KAL5-N-SW-OF
64kg



SW
QUARRYCAST™ Blanc.
QUARRYCAST™ Weiß.
QUARRYCAST™ Bianco.
QUARRYCAST™ Wit.





Kaldera 6

○ KAL6-N-SW-OF

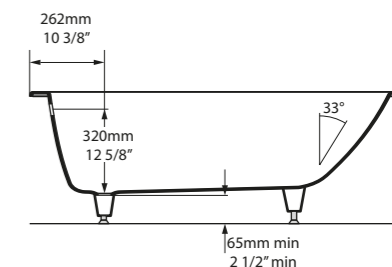
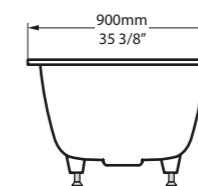
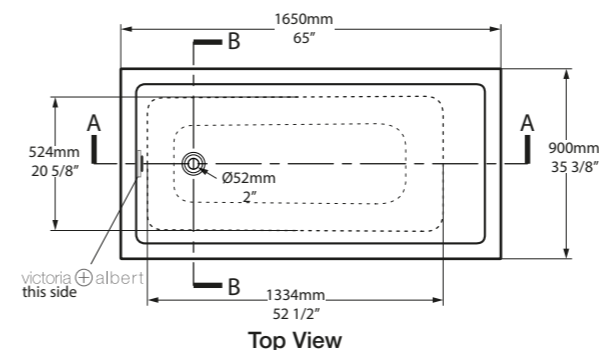

Front View

Section AA

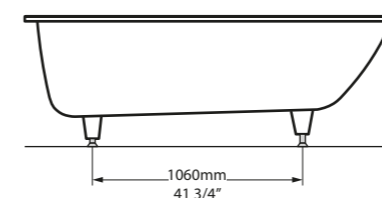

Side View

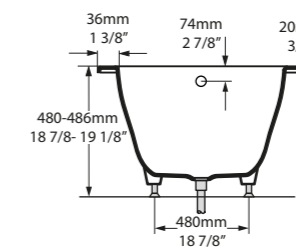

Section BB

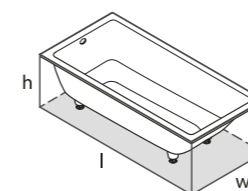
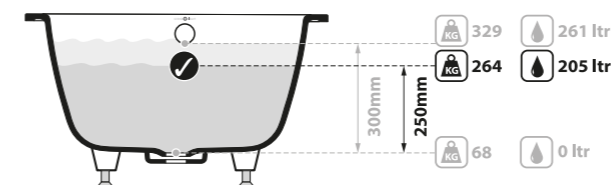
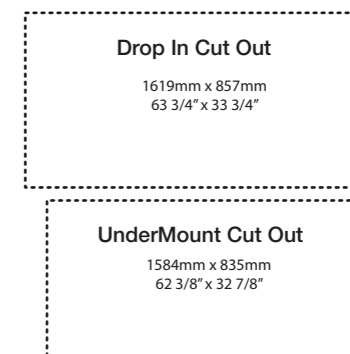

l = 1650mm/65"
w = 900mm/35 3/8"
h = 480-486mm/18 7/8-19 1/8"

○ KAL6-N-SW-OF
68kg



Avec sa conception ergonomique, la Kaldera 6 offre un confort optimal et convient aussi bien aux installations encastrées que sous plan. Ses lignes épurées et son aspect luxueux en font la baignoire idéale aussi bien pour les salles de bains d'hôtels que de résidences privées. La Kaldera 6 est la plus grande baignoire de la collection avec ses 1650mm de long.

- Inclinaison à 32°;
 - Bords découpés avec précision - idéal pour les installations contre un mur ou en angle;
 - Quatre pieds réglables pour un parfait nivellement.
- Voir également les baignoires plus compactes Kaldera 4 et Kaldera 5.

Kaldera 6 wurde ergonomisch design't und ist geeignet zur Aufsatzmontage oder für den Einbau mit versenktem Rand. Kaldera 6 bringt klare Formen und luxuriösen Stil ins Badezimmer und eignet sich sowohl für den Einsatz im Privatbereich, als auch für den Einsatz in Hotels. Mit ihren 1650 Millimetern ist sie die längste Wanne dieser Kollektion.

- Neigungswinkel 32 Grad;
- Rand mit akkuratem Diamantschnitt, ideal für die Wand - sowie die Eckmontage;
- 4 verstellbare Füße für einen perfekten Stand.

Beachten Sie auch die kompakteren Modelle Kaldera 4 sowie Kaldera 5.

Kaldera 6 è progettata ergonomicamente per il massimo comfort e adatta per installazioni ad incasso e montate sotto. Kaldera 6 regala al bagno linee pulite e stile lussuoso, prestandosi sia ad applicazioni residenziali che ad hotel. Kaldera 6 è la vasca più grande della collezione, misurando 1650mm.

- Angolo di inclinazione di 32°;
 - Bordo diamantato - ideale per installazioni a parete o ad angolo;
 - Quattro piedini regolabili per un perfetto livellamento.
- Vedi anche le vasche Kaldera 4 e Kaldera 5 più compatte.

Kaldera 6 is ergonomisch ontworpen voor maximaal comfort en geschikt voor zowel inbouw- als onderbouwinstallaties. Kaldera 6 brengt strakke lijnen en luxe stijl naar de badkamer en leent zichzelf voor toepassingen in zowel woningen als hotels. Kaldera 6 is de langste van de collectie met een lengte van 1650mm.

- Een rugleuning van 32°;
- Nauwkeurige diamantgeneden kanten
- Ideaal voor tegen-de-muur of hoekinstallaties;
- Vier verstelbare poten voor perfecte nivellering.

Zie ook de meer compactere Kaldera 4 en Kaldera 5.

SW
QUARRYCAST™ Blanc.
QUARRYCAST™ Weiß.
QUARRYCAST™ Bianco.
QUARRYCAST™ Wit.





Basins

Agrémentez votre baignoire avec une de nos vasques à poser qui vous correspond. Choisissez entre un style moderne ou plus traditionnel. Certains modèles ont été conçus pour être associés à des baignoires spécifiques, alors que d'autres conviennent naturellement à toutes les formes et tous les styles. Découvrez notre gamme de couleurs RAL en finition mate ou brillante.

Ergänzen Sie Ihr Bad mit einem unserer freistehenden Waschbecken. Wählen Sie zwischen modernen und traditionellen Stilrichtungen. Einige Modelle wurden passend zu bestimmten Wannenserien entwickelt, andere lassen sich wiederum wunderbar mit vielen verschiedenen Designs und Formen kombinieren. Schauen Sie sich das Spektrum der verfügbaren RAL-Farben in glänzender und matter Oberfläche an.

Completa la tua vasca con uno dei nostri corrispondenti lavabi freestanding. Con gli stili moderni e tradizionali tra cui scegliere, sono stati progettati una serie di modelli per soddisfare certe vasche, mentre altri completano naturalmente molteplici forme e stili. Esplora la nostra gamma di colori RAL con finiture lucide e opache.

Vul uw vrijstaand bad aan met onze opzetwastafels. Kies uit moderne of traditionele stijlen, een aantal modellen zijn specifiek ontworpen om ter aanvulling op specifieke baden, terwijl anderen perfect bij verschillende vormen passen. Ontdek ons spectrum van RAL-kleuren in glanzende of matte afwerkingen.

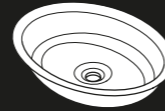
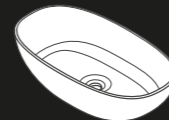
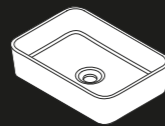

Drayton 40
400 x 400
Page 184

Maru 42
423 x 423
Page 192

Edge 45
450 x 325
Page 186

Barcelona 48
480 x 301
Page 176

Radford 51
510 x 395
Page 196

Internal overflow

Standard Matt

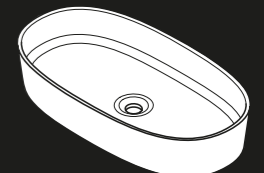
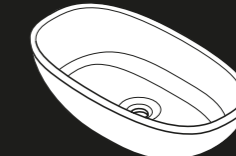
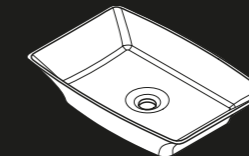
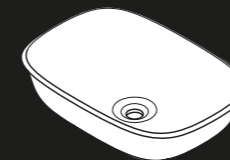

Amiata 60
600 x 413
Page 174

Ravello 60
612 x 411
Page 198

Barcelona 64
635 x 346
Page 180

ios 80
810 x 432
Page 190

Internal overflow

Standard Matt

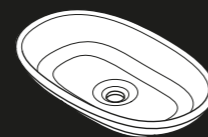
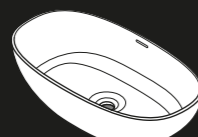
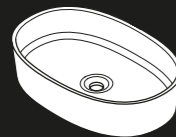

ios 54
540 x 362
Page 188

Barcelona 55
546 x 329
Page 178

Amalfi 55
550 x 340
Page 172

Cabrits 55
550 x 340
Page 182

Napoli 57
570 x 345
Page 194

Internal overflow

Standard Matt



Internal overflow / Trop-plein intégré / Integrierter Überlauf / Troppopieno interno / Geïntegreerde overloop.
Standard Matt / Blanc Mat / Standard Matt / Standard Opaco / Standaard Mat.



○ VB-AML-55-NO  ○ VB-AML55M-SM-NO 

  Massachusetts Code
cUPC listing by IAPMO

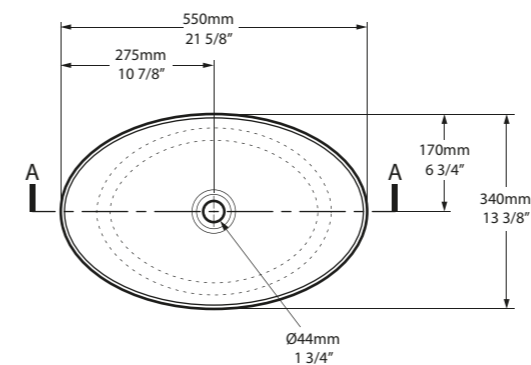

Top View

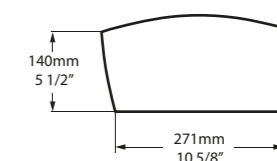

Side View

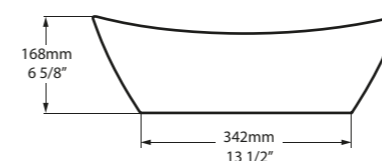

Front View

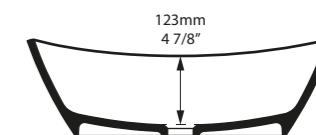

Section AA

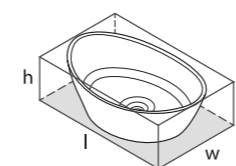

l = 550mm/21 5/8"
w = 340mm/13 3/8"
h = 168mm/6 5/8"

○ VB-AML-55-NO
○ VB-AML55M-SM-NO
● PAINT-VB
6kg

La vasque Amalfi 55 est caractérisée par des lignes épurées et des courbes élégantes. Elle a été conçue pour accompagner la baignoire Amalfi mais fonctionne aussi bien avec n'importe laquelle de nos baignoires modernes. Découvrez notre gamme de couleurs RAL en finition mate ou brillante.

Das Amalfi 55 Becken besticht durch klare Linien und elegante Rundungen. Es wurde als Ergänzung zur Amalfi Wanne gestaltet, harmonisiert aber ebenso mit unseren anderen modernen Wannen. Schauen Sie sich das Spektrum der verfügbaren RAL-Farben in glänzender und matter Oberfläche an.

L'Amalfi 55 è caratterizzato da linee pulite e curve eleganti. È stato progettato per completare la vasca Amalfi, ma è abbinabile con qualsiasi nostra vasca moderna. Esplori la nostra gamma di colori RAL con finiture lucide e opache.

De Amalfi 55 wordt gekenmerkt door strakke lijnen en elegante rondingen. Het is ontworpen ter aanvulling op het Amalfi bad, maar past eigenlijk goed bij al onze moderne baden. Ontdek ons spectrum van RAL-kleuren in glanzende of matte afwerkingen.

SW QUARRYCAST™ Blanc.
QUARRYCAST™ Weiß.
QUARRYCAST™ Bianco.
QUARRYCAST™ Wit.

SM QUARRYCAST™ Blanc Mat.
QUARRYCAST™ Standard Matt.
QUARRYCAST™ Standard Opaco.
QUARRYCAST™ Standaard Mat.

 rich in
Vulkano
Limestone™



 Personalisez.
Personalisieren.
Personalizza.
Personaliseren.



Amiata 60

○ VB-AMT-60-NO 

CE  Massachusetts Code
cUPC listing by IAPMO

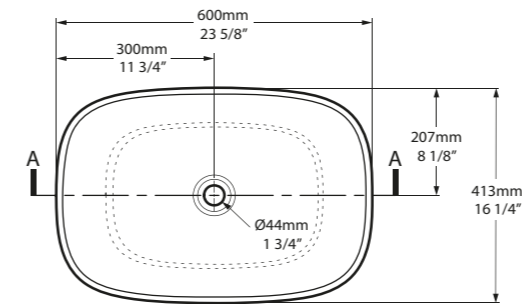

Top View

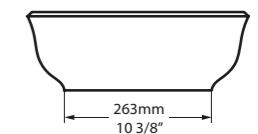

Side View

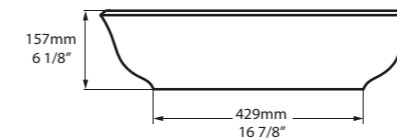

Front View

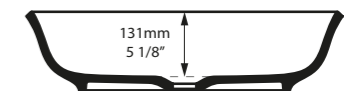

Section AA

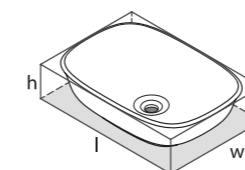
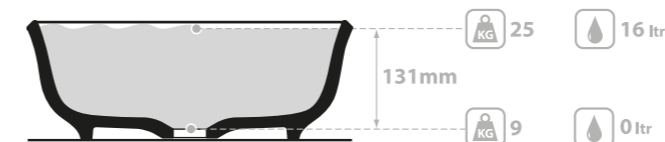

l = 600mm/23 5/8"
w = 413mm/16 1/4"
h = 157mm/6 1/8"

○ VB-AMT-60-NO
🖌️ PAINT-VB
9kg

SW QUARRYCAST™ Blanc.
QUARRYCAST™ Weiß.
QUARRYCAST™ Bianco.
QUARRYCAST™ Wit.

QC rich in volcanic Limestone



Personnalisez.
Personalisieren.
Personalizza.
Personaliseren.



reddot award 2015
winner

Amiata 60 est une vasque à poser généreuse conçue pour accompagner la baignoire en îlot Amiata. Conçue par Meneghello Paoletti Associati. Découvrez notre gamme de couleurs RAL en finition mate ou brillante.

Das Amiata 60 Becken ist ein großzügig bemessenes Aufsatzwaschbecken und wurde als Ergänzung zur freistehenden Amiata Wanne gestaltet. Designed von Meneghello Paoletti Associati. Schauen Sie sich das Spektrum der verfügbaren RAL-Farben in glänzender und matter Oberfläche an.

L'Amiata 60 è un lavabo di dimensioni generose, progettato per integrare la vasca freestanding Amiata. Progettato da Meneghello Paoletti Associati. Esplori la nostra gamma di colori RAL con finiture lucide e opache.

De Amiata 60 is een ruime opzetwastafel passend bij het Amiata vrijstaande bad. Ontworpen door Meneghello Paoletti Associati. Ontdek ons spectrum van RAL-kleuren in glanzende of matte afwerkingen.



Barcelona 48

○ VB-BAR-48-NO  ○ VB-BAR48M-SM-NO 

  Massachusetts Code
cUPC listing by IAPMO

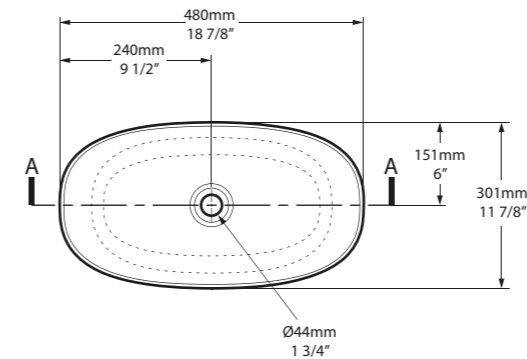

Top View

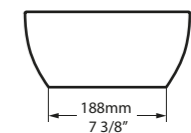

Side View



Front View

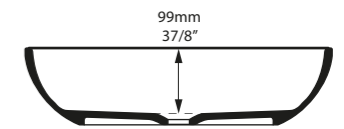

Section AA

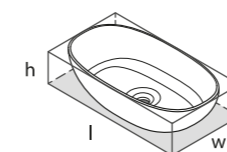
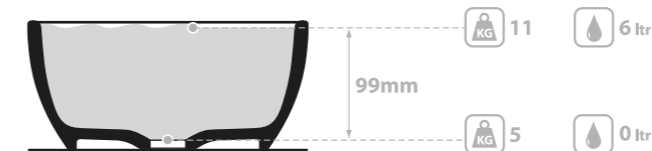

l = 480mm/18 7/8"
w = 301mm/11 7/8"
h = 120mm/4 3/4"

○ VB-BAR-48-NO
○ VB-BAR48M-SM-NO
PAINT-VB
5kg

SW QUARRYCAST™ Blanc.
QUARRYCAST™ Weiß.
QUARRYCAST™ Bianco.
QUARRYCAST™ Wit.

SM QUARRYCAST™ Blanc Mat.
QUARRYCAST™ Standard Matt.
QUARRYCAST™ Standard Opaco.
QUARRYCAST™ Standaard Mat.

 rich in
Vikarino
Limestone™



 Personalisez.
Personalisieren.
Personalizza.
Personaliseren.



Barcelona 48 est une vasque élégante en forme de galet. Elle s'associe parfaitement aux baignoires Barcelona, et est idéale dans les toilettes ou en aménagement duo. Découvrez notre gamme de couleurs RAL en finition mate ou brillante. Voir également les modèles Barcelona 55 et Barcelona 64.

Das Barcelona 48 Becken ist glatt und kieselsteinförmig gestaltet; die perfekte Ergänzung zu den Barcelona Wannen. Ideal für Gäste-WCs oder als Doppelwaschtisch. Schauen Sie sich das Spektrum der verfügbaren RAL-Farben in glänzender und matter Oberfläche an. Beachten Sie ebenfalls Barcelona 55 und 64.

Barcelona 48 è un lavabo elegante a forma di sasso; complementa perfettamente le vasche Barcelona. Ideale per piccoli bagni o in coppia nelle impostazioni 'Lui' e 'Lei'. Esplori la nostra gamma di colori RAL con finiture lucide e opache. Vedi inoltre Barcelona 55 e Barcelona 64.

De Barcelona 48 is een slanke kiesel-vormige bekken; de perfecte aanvulling op de Barcelona baden. Ideaal voor de kleine badkamer of in duo opzet 'voor hem en haar'. Ontdek ons spectrum van RAL-kleuren in glanzende of matte afwerkingen. Zie ook Barcelona 55 en Barcelona 64.

○ VB-BAR-55-IO  ○ VB-BAR55M-SM-IO 

  Massachusetts Code
cUPC listing by IAPMO

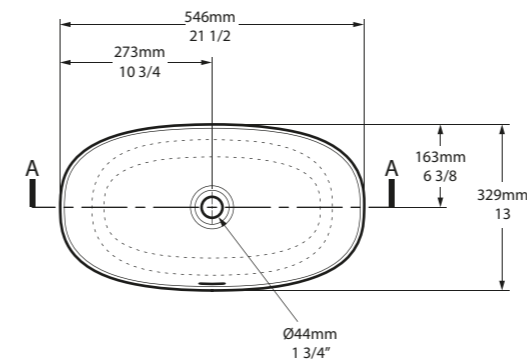

Top View

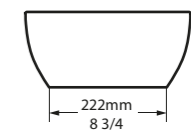

Side View

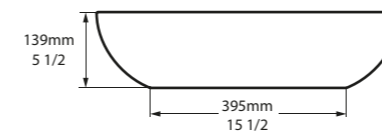

Front View

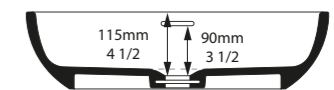

Section AA

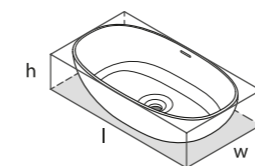



l = 546mm/21 1/2"
w = 329mm/13"
h = 139mm/5 1/2"

○ VB-BAR-55-IO
○ VB-BAR55M-SM-IO
PAINT-VB
7kg

SW QUARRYCAST™ Blanc.
QUARRYCAST™ Weiß.
QUARRYCAST™ Bianco.
QUARRYCAST™ Wit.

SM QUARRYCAST™ Blanc Mat.
QUARRYCAST™ Standard Matt.
QUARRYCAST™ Standard Opaco.
QUARRYCAST™ Standaard Mat.

QC rich in
Vicatano
Limestone™

  Personalisez.
Personalisieren.
Personalizza.
Personaliseren.



La vasque Barcelona 55 complète idéalement aux baignoires Barcelona, et est idéale dans les toilettes ou en aménagement duo. Dispose d'un trop-plein intégré. Découvrez notre gamme de couleurs RAL en finition mate ou brillante. Voir également les modèles Barcelona 48 et Barcelona 64.

Das Becken Barcelona 55 ist die perfekte Ergänzung zu den Barcelona Wannen. Ideal für Gäste-WCs oder als Doppelwaschtisch. Mit eingebautem Überlauf. Schauen Sie sich das Spektrum der verfügbaren RAL-Farben in glänzender und matter Oberfläche an. Beachten Sie ebenfalls Barcelona 48 und Barcelona 64.

Barcelona 55 complementa perfettamente le vasche Barcelona. Caratterizzato da un troppopieno interno. Esplori la nostra gamma di colori RAL con finiture lucide e opache. Vedi inoltre Barcelona 48 e Barcelona 64.

De Barcelona 55 is de perfecte aanvulling op de Barcelona baden. Voorzien van geïntegreerde overloop. Ontdek ons spectrum van RAL-kleuren in glanzende of matte afwerkingen. Zie ook Barcelona 48 en Barcelona 64.



○ VB-BAR-64-NO  ○ VB-BAR64M-SM-NO 

  Massachusetts Code
cUPC listing by IAPMO

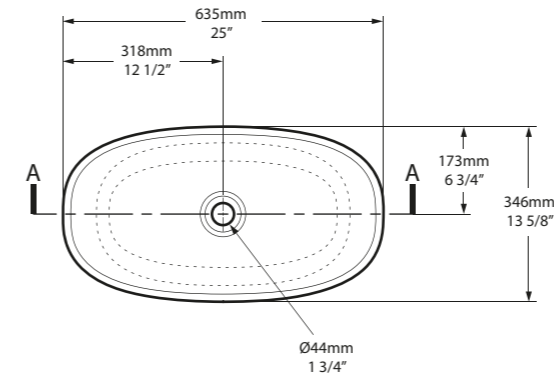

Top View

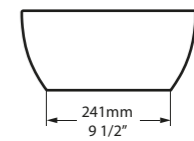

Side View

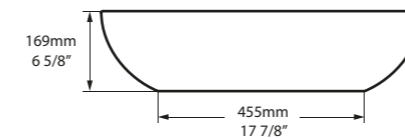

Front View

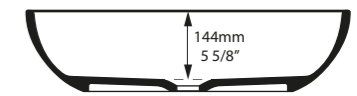

Section AA

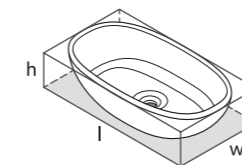
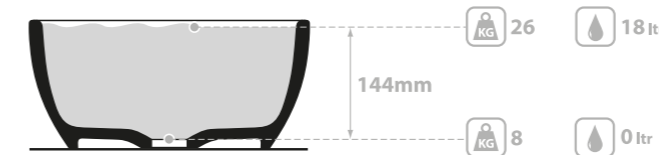

l = 635mm/25"
w = 346mm/13 5/8"
h = 169mm/6 5/8"

○ VB-BAR-64-NO
○ VB-BAR64M-SM-NO
PAINT-VB
8kg



Barcelona 64 est une vasque aux dimensions généreuses, en forme de galet. Elle s'associe parfaitement aux baignoires Barcelona. Découvrez notre gamme de couleurs RAL en finition mate ou brillante. Voir également les modèles Barcelona 48 et Barcelona 55.

Barcelona 64 ist ein großes, kieselsteinförmiges Becken; die perfekte Ergänzung zu den Barcelona Wannen. Ideal für Gäste-WCs oder als Doppelwaschtisch. Schauen Sie sich das Spektrum der verfügbaren RAL-Farben in glänzender und matter Oberfläche an. Beachten Sie ebenfalls Barcelona 48 und Barcelona 55.

Barcelona 64: Un ampio lavabo senza bordo e' stato progettato da abbinare perfettamente alle vasche Barcelona. Esplori la nostra gamma di colori RAL con finiture lucide e opache. Vedi inoltre Barcelona 48 e Barcelona 55.

De Barcelona 64 is een ruim kiezel-vormige wasbak; perfect passend bij de Barcelona baden. Ontdek ons spectrum van RAL-kleuren in glanzende of matte afwerkingen. Zie ook Barcelona 48 en Barcelona 55.

SW QUARRYCAST™ Blanc.
QUARRYCAST™ Weiß.
QUARRYCAST™ Bianco.
QUARRYCAST™ Wit.

SM QUARRYCAST™ Blanc Mat.
QUARRYCAST™ Standard Matt.
QUARRYCAST™ Standard Opaco.
QUARRYCAST™ Standaard Mat.

QC rich in
Vicatano
Limestone™

  Personalisez.
Personalisieren.
Personalizza.
Personaliseren.



Cabrits 55

○ VB-CAB-55-NO 

CE  Massachusetts Code
cUPC listing by IAPMO

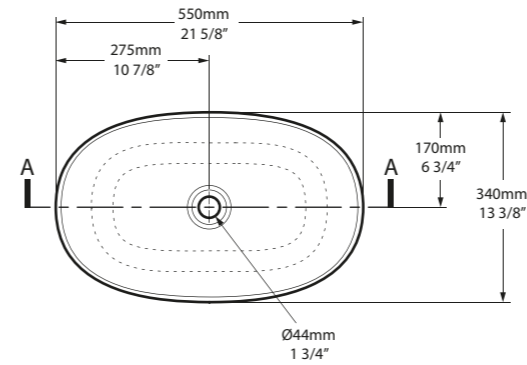

Top View

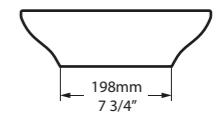

Side View

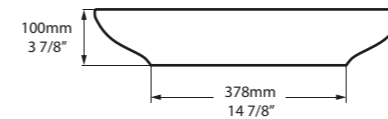

Front View

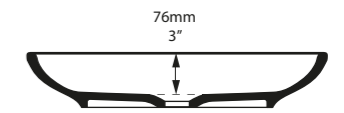

Section AA

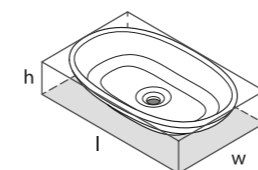
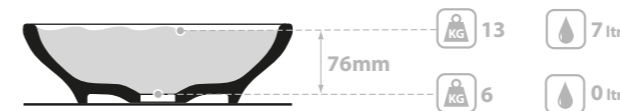

l = 550mm/21 5/8"
w = 340mm/13 3/8"
h = 100mm/3 7/8"

○ VB-CAB-55-NO
PAINT-VB
6kg

SW QUARRYCAST™ Blanc.
QUARRYCAST™ Weiß.
QUARRYCAST™ Bianco.
QUARRYCAST™ Wit.

QC rich in
Volcanic
Limestone



Personnalisez.
Personalisieren.
Personalizza.
Personaliseren.

La vasque Cabrits 55 est une vasque sophistiquée, basse, et caractérisée par des courbes singulières. Conçue pour accompagner la baignoire Cabrits. Découvrez notre gamme de couleurs RAL en finition mate ou brillante.

Das Cabrits 55 Waschbecken ist ein tief geschnittenes, elegantes Waschbecken mit komplexen Kurven, und damit die ideale Ergänzung zur Cabrits Wanne. Schauen Sie sich das Spektrum der verfügbaren RAL-Farben in glänzender und matter Oberfläche an.

Il lavabo Cabrits 55 e' un sofisticato lavabo dall forma gradevole e snella, progettato per integrare la vasca Cabrits. Esplori la nostra gamma di colori RAL con finiture lucide e opache.

De lage Cabrits 55 wasbak heeft complexe rondingen, ontworpen ter aanvulling op het bad Cabrits. Ontdek ons spectrum van RAL-kleuren in glanzende of matte afwerkingen.



○ VB-DRA-40-NO 

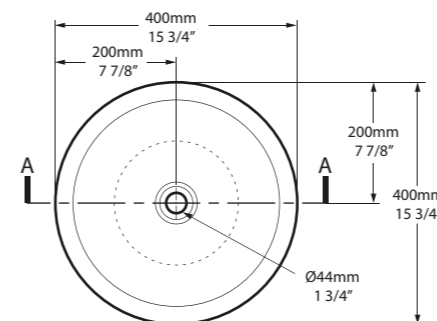

Top View

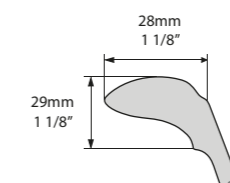

Rim Detail

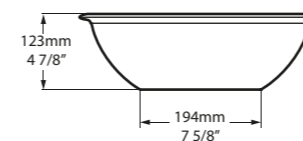

Front View

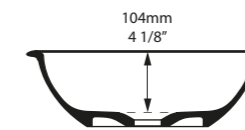

Section AA

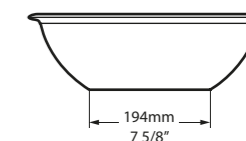

Side View

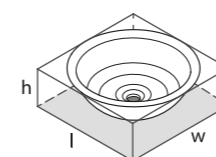
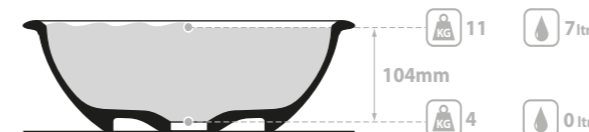

l = 400mm/15 3/4"
w = 400mm/15 3/4"
h = 123mm/4 7/8"

○ VB-DRA-40-NO
PAINT-VB
4kg

 QUARRYCAST™ Blanc.
QUARRYCAST™ Weiß.
QUARRYCAST™ Bianco.
QUARRYCAST™ Wit.

 rich in
Volcanic
Limestone™



Personnalisez.
Personalisieren.
Personalizza.
Personaliseren.



La Drayton 40 est une vasque à poser de style traditionnel avec un rebord tout en finesse. Conçue pour accompagner la baignoire en filot Drayton. Découvrez notre gamme de couleurs RAL en finition mate ou brillante.

Drayton 40 ist ein traditionelles Aufsatzwaschbecken mit fein verziertem Rand. Designed als Ergänzung zur freistehenden Drayton Wanne. Schauen Sie sich das Spektrum der verfügbaren RAL-Farben in glänzender und matter Oberfläche an.

Il lavandino Drayton 40 tradizionale con sottile dettgalio sul bordo che può essere montato ad appoggio o incasso. Esplori la nostra gamma di colori RAL con finiture lucide e opache.

De Drayton 40 is een traditionele wasbak met subtiële rand detaillering. Passend bij het Drayton bad. Ontdek ons spectrum van RAL-kleuren in glanzende of matte afwerkingen.



○ VB-EDG-45-NO 

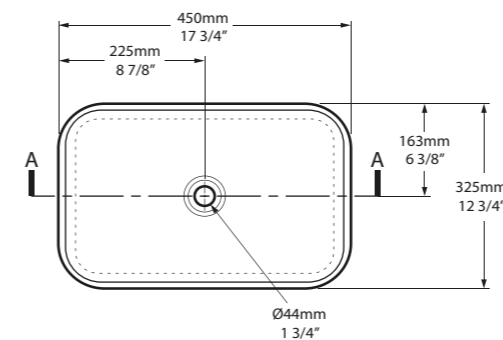

Top View

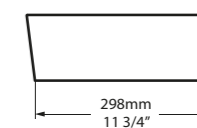

Side View

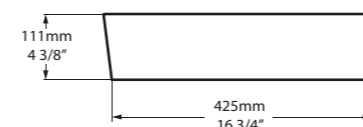

Front View

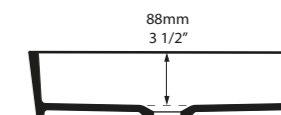

Section AA

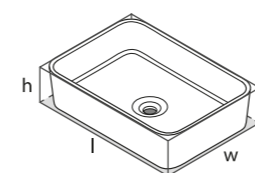
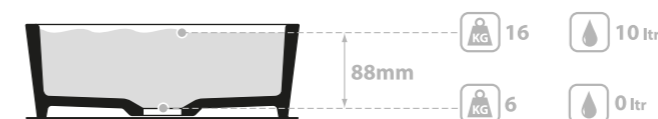

l = 450mm/17 3/4"
w = 325mm/12 3/4"
h = 111mm/4 3/8"

○ VB-EDG-45-NO
PAINT-VB
6kg

SW QUARRYCAST™ Blanc.
QUARRYCAST™ Weiß.
QUARRYCAST™ Bianco.
QUARRYCAST™ Wit.

rich in
Volcanic
Limestone™



Personnalisez.
Personalisieren.
Personalizza.
Personaliseren.

Compacte, la vasque Edge 45 se distingue par ses formes cubiques. Parfaite pour accompagner la baignoire Edge. Découvrez notre gamme de couleurs RAL en finition mate ou brillante.

Edge 45 ist ein kompakt bemessenes Waschbecken im kubischen Stil. Perfekt in Kombination mit der Edge Wanne. Schauen Sie sich das Spektrum der verfügbaren RAL-Farben in glänzender und matter Oberfläche an.

Il lavabo Edge 45 e' compatto e caratterizzato da uno stile cubico. Perfetto per completare la vasca Edge. Esplori la nostra gamma di colori RAL con finiture lucide e opache.

De Edge 45 is een compacte kubistische gestylde wasbak. Perfect te combineren met het Edge bad. Ontdek ons spectrum van RAL-kleuren in glanzende of matte afwerkingen.



○ VB-IOS-54-NO  ○ VB-IOS54M-SM-NO 

CE  Massachusetts Code
cUPC listing by IAPMO

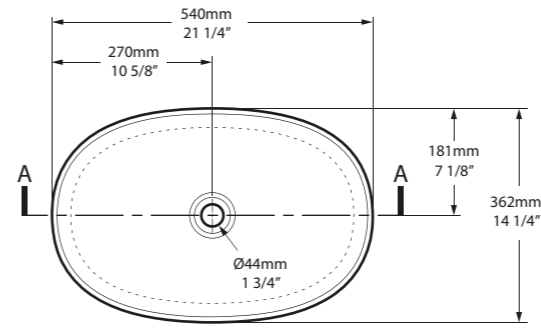

Top View

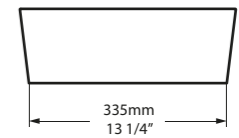

Side View

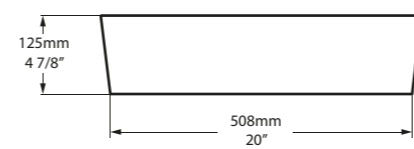

Front View

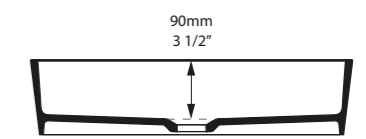

Section AA

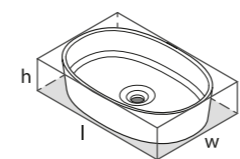
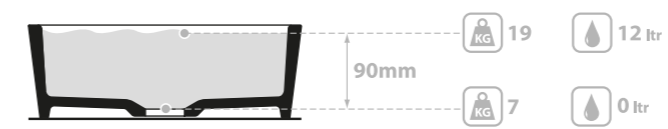

l = 540mm/21 1/4"
w = 362mm/14 1/4"
h = 125mm/4 7/8"

○ VB-IOS-54-NO
○ VB-IOS54M-SM-NO
PAINT-VB
7kg



La vasque à poser ios 54 sans rebord a été conçue pour accompagner la baignoire ios. Disponible également dans des dimensions plus généreuses, consulter ios 80. Découvrez notre gamme de couleurs RAL en finition mate ou brillante.

ios 54 ist ein randloses Aufsatzwaschbecken und eine Ergänzung zur ios Wanne. Auch in größeren Abmessungen erhältlich, siehe ios 80. Schauen Sie sich das Spektrum der verfügbaren RAL-Farben in glänzender und matter Oberfläche an.



L'ios 54 è un lavabo senza montatura progettato per integrare la vasca ios. Disponibile anche in ampie dimensioni vedi ios 80. Esplori la nostra gamma di colori RAL con finiture lucide e opache.

De ios 54 is een randloze opzetwastafel ontworpen ter aanvulling op het ios bad. Ook verkrijgbaar in een groter formaat zie ios 80. Ontdek ons spectrum van RAL-kleuren in glanzende of matte afwerkingen.

SW QUARRYCAST™ Blanc.
QUARRYCAST™ Weiß.
QUARRYCAST™ Bianco.
QUARRYCAST™ Wit.

SM QUARRYCAST™ Blanc Mat.
QUARRYCAST™ Standard Matt.
QUARRYCAST™ Standard Opaco.
QUARRYCAST™ Standaard Mat.

QC rich in
Vicatano
Limestone™

  Personalisez.
Personalisieren.
Personalizza.
Personaliseren.



○ VB-IOS-80-NO 

  Massachusetts Code
cUPC listing by IAPMO

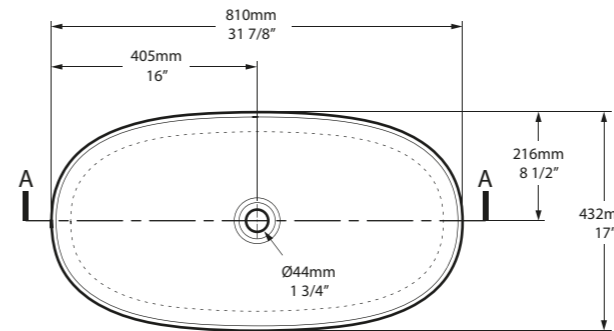

Top View

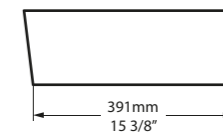

Side View

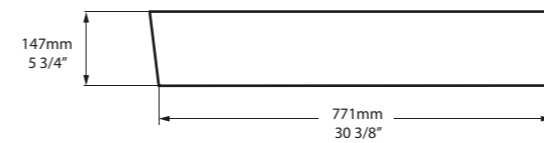

Front View

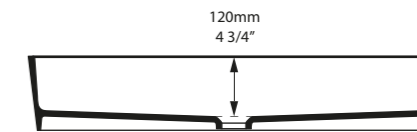

Section AA

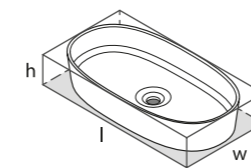
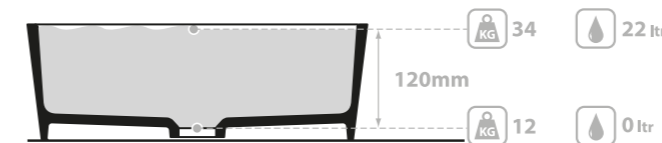

l = 810mm/31 7/8"
w = 432mm/17"
h = 147mm/5 3/4"

○ VB-IOS-80-NO
🔧 PAINT-VB
12kg



La vasque à poser ios 80 et ses proportions généreuses à été conçue pour accompagner la baignoire ios. Disponible dans des dimensions plus réduites, consulter ios 54. Découvrez notre gamme de couleurs RAL en finition mate ou brillante.

ios 80 ist ein großzügig bemessenes Aufsatzwaschbecken und eine Ergänzung zur ios Wanne. Auch in kleineren Abmessungen erhältlich, siehe ios 54. Schauen Sie sich das Spektrum der verfügbaren RAL-Farben in glänzender und matter Oberfläche an.

L'ios 80 e' un generoso lavabo progettato per complementare la vasca ios. Disponibile inoltre in piccole dimensioni - vedi ios 54. Esplori la nostra gamma di colori RAL con finiture lucide e opache.

De ios 80 is een royale opzetwastafel passend bij het ios bad. Ook verkrijgbaar in een kleiner formaat- zie ios 54. Ontdek ons spectrum van RAL-kleuren in glanzende of matte afwerkingen.



QUARRYCAST™ Blanc.
QUARRYCAST™ Weiß.
QUARRYCAST™ Bianco.
QUARRYCAST™ Wit.



Personnalisez.
Personalisieren.
Personalizza.
Personaliseren.



○ VB-MAU-42-NO

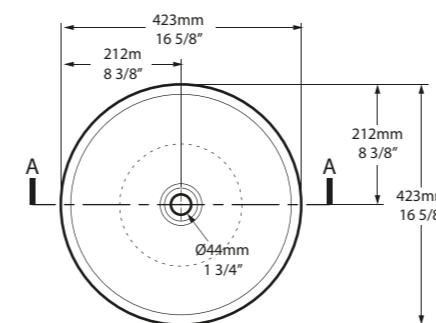

Top View

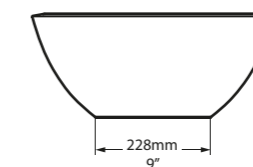

Side View

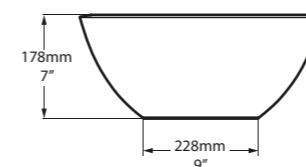

Front View

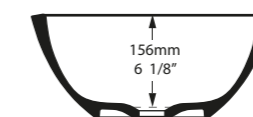

Section AA

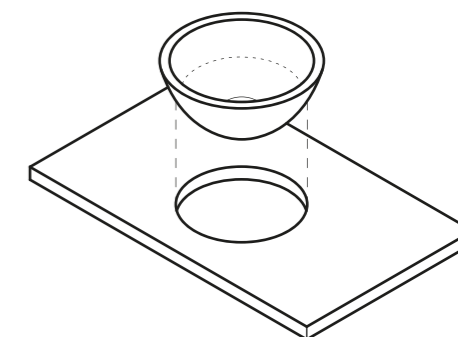
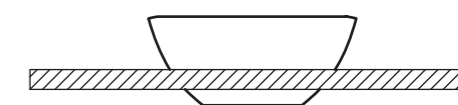

Semi Recessed

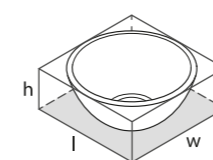
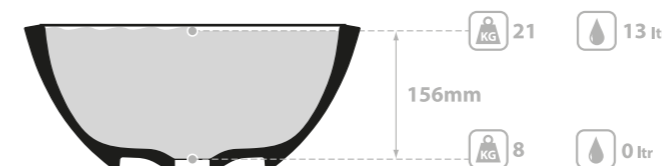

l = 423mm/16 5/8"
w = 423mm/16 5/8"
h = 178mm/7"

○ VB-MAU-42-NO
PAINT-VB
8kg



QUARRYCAST™ Blanc.
QUARRYCAST™ Weiß.
QUARRYCAST™ Bianco.
QUARRYCAST™ Wit.



Personnalisez.
Personalisieren.
Personalizza.
Personaliseren.



Une vasque hémisphérique et profonde aux dimensions généreuses, dotée d'un design sans rebord, adaptée à la pose sur plan ou semi-encastée. Idéale pour des aménagement en duo. Découvrez notre gamme de couleurs RAL en finition mate ou brillante.

Ein halbkugelförmig gestaltetes Becken mit randlosem Design und von großzügiger Tiefe. Sowohl als Aufsatzwaschbecken, als auch für den halb versenkten Einbau geeignet. Ideal als Doppelwaschtisch. Schauen Sie sich das Spektrum der verfügbaren RAL-Farben in glänzender und matter Oberfläche an.

Un lavabo emisferico generosamente profondo con il design senza montatura; adatto per il montaggio ad appoggio o a semi-incasso. Ideale per una impostazione "lui" e "lei". Esplori la nostra gamma di colori RAL con finiture lucide e opache.

Een royaal ronde en diepe wasbak; geschikt voor opzet als ook half-verzonken instalatie. Ideaal voor een 'hem en haar' setting. Ontdek ons spectrum van RAL-kleuren in glanzende of matte afwerkingen.



Napoli 57

○ VB-NAP-57-NO  ○ VB-NAP57M-SM-NO 

CE  Massachusetts Code
cUPC listing by IAPMO

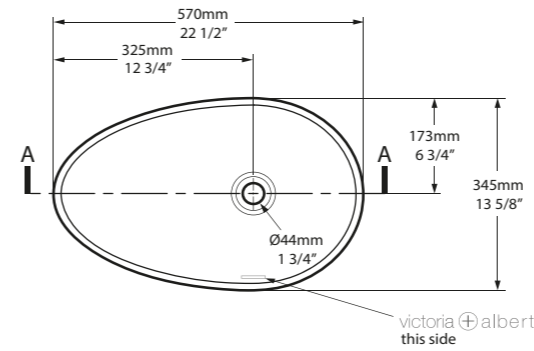

Side View

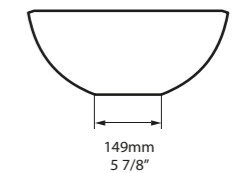

Top View

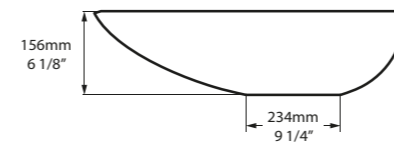

Front View

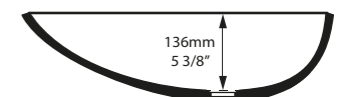

Section AA

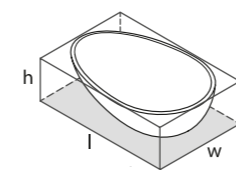
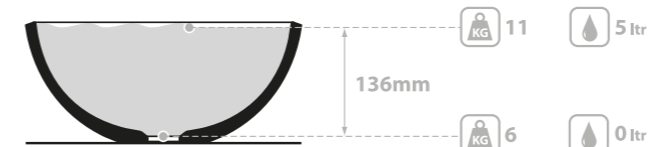

l = 570mm/22½"
w = 345mm/13⅝"
h = 156mm/6⅛"

○ VB-NAP-57-NO
○ VB-NAP57M-SM-NO
PAINT-VB
6kg



La vasque Napoli 57 et sa forme asymétrique est la pièce maîtresse de toutes les salles de bains. Conçue pour accompagner la baignoire en îlot Napoli. Découvrez notre gamme de couleurs RAL en finition mate ou brillante.

Das eiförmige, asymmetrische Napoli 57 Becken wird in jedem Badezimmer zum Blickfang. Designed als Ergänzung zur freistehenden Napoli Wanne. Schauen Sie sich das Spektrum der verfügbaren RAL-Farben in glänzender und matter Oberfläche an.

Il lavabo asimmetrico Napoli 57 a forma di uovo è un punto focale in ogni bagno. Progettato per completare la vasca freestanding Napoli. Esplori la nostra gamma di colori RAL con finiture lucide e opache.

Het ei-vormige asymmetrische Napoli 57 wasbak is een centraal punt in een badkamer. Ontworpen om het Napoli bad aan te vullen. Ontdek ons spectrum van RAL-kleuren in glanzende of matte afwerkingen.

SW QUARRYCAST™ Blanc.
QUARRYCAST™ Weiß.
QUARRYCAST™ Bianco.
QUARRYCAST™ Wit.

SM QUARRYCAST™ Blanc Mat.
QUARRYCAST™ Standard Matt.
QUARRYCAST™ Standard Opaco.
QUARRYCAST™ Standaard Mat.

QC rich in
Vicatano
Limestone™



Personalisez.
Personalisieren.
Personalizza.
Personaliseren.



○ VB-RAD-51-NO 

CE  Massachusetts Code cUPC listing by IAPMO

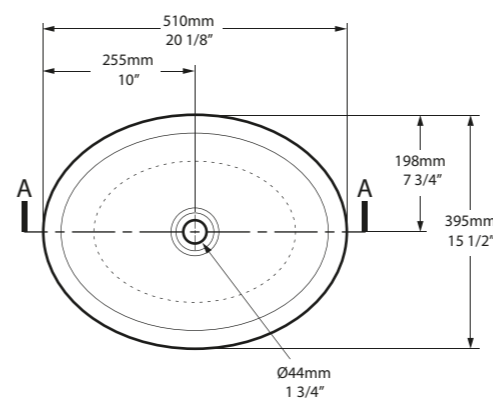

Top View

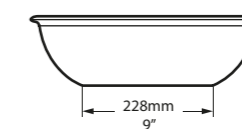

Side View

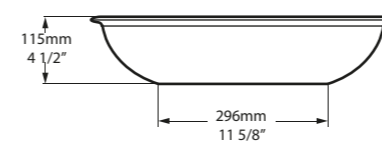

Front View

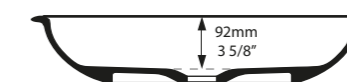

Section AA

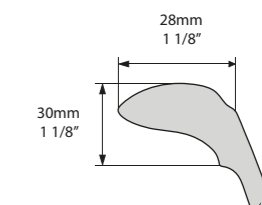

Rim Detail

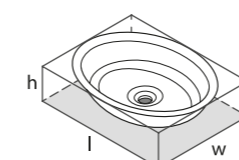
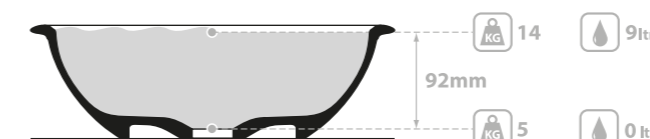

l = 510mm/20 1/8"
w = 395mm/15 1/2"
h = 115mm/4 1/2"

○ VB-RAD-51-NO
■ PAINT-VB
5kg

SW QUARRYCAST™ Blanc.
QUARRYCAST™ Weiß.
QUARRYCAST™ Bianco.
QUARRYCAST™ Wit.

QC rich in volcanic Limestone



Personnalisez.
Personalisieren.
Personalizza.
Personaliseren.



La Radford 51 est une vasque à poser de style traditionnel avec un rebord tout en finesse. Conçue pour accompagner la baignoire en îlot Radford. Découvrez notre gamme de couleurs RAL en finition mate ou brillante.

Radford 51 ist ein traditionelles Aufsatzwaschbecken mit fein verziertem Rand. Designed als Ergänzung zur freistehenden Radford Wanne. Schauen Sie sich das Spektrum der verfügbaren RAL-Farben in glänzender und matter Oberfläche an.

Il lavandino Radford 51 tradizionale con sottile dettgalio sul bordo che può essere montato ad appoggio o incasso. Esplori la nostra gamma di colori RAL con finiture lucide e opache.

De Radford 51 is een traditionele wasbak met subtiel rand detaillering. Passend bij het Radford bad. Ontdek ons spectrum van RAL-kleuren in glanzende of matte afwerkingen.



Les lignes sculpturales de la vasque Ravello 60 s'harmonisent avec la baignoire Ravello. Découvrez notre gamme de couleurs RAL en finition mate ou brillante.

Die skulpturalen Linien des Ravello 60 Beckens entsprechen denen der Ravello Wanne. Schauen Sie sich das Spektrum der verfügbaren RAL-Farben in glänzender und matter Oberfläche an.

Il lavabo Ravello 60 dalle linee scultoree completa la vasca Ravello. Esplori la nostra gamma di colori RAL con finiture lucide e opache.

De Ravello 60 wasbak met zijn sculpturale lijnen is een aanvulling op het Ravello Bad. Ontdek ons spectrum van RAL-kleuren in glanzende of matte afwerkingen.

Ravello 60

○ VB-RAV-60-NO 

CE  Massachusetts Code cUPC listing by IAPMO

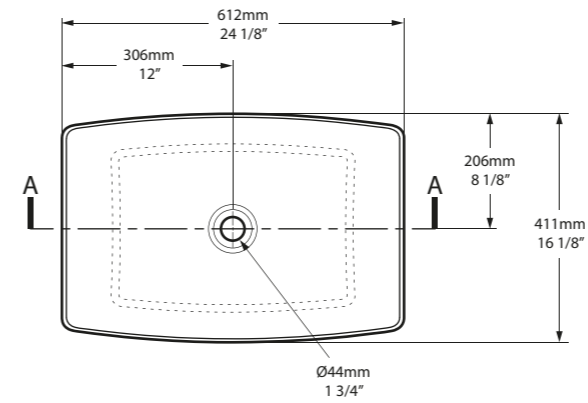

Top View

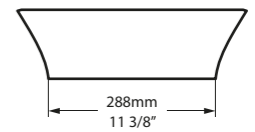

Side View

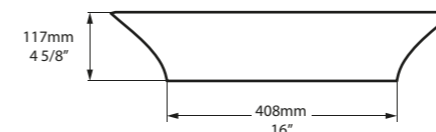

Front View

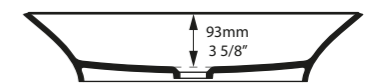

Section AA

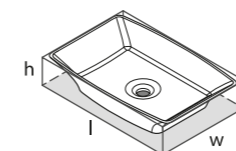
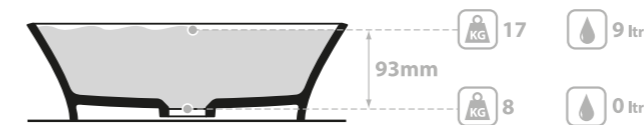

l = 612mm/24 1/8"
w = 411mm/16 1/8"
h = 117mm/4 5/8"

○ VB-RAV-60-NO
PAINT-VB
8kg

SW QUARRYCAST™ Blanc.
QUARRYCAST™ Weiß.
QUARRYCAST™ Bianco.
QUARRYCAST™ Wit.

QC rich in volcanic Limestone™



Personnalisez.
Personalisieren.
Personalizza.
Personaliseren.



Recessed basins

Notre gamme de vasques encastrées QUARRYCAST™ comprend des styles modernes et traditionnels pour de nombreuses possibilités d'installation.

Disponibles dans différentes tailles et formes - rondes, ovales ou rectangulaires - vous êtes assurés de trouver un format qui convienne à vos besoins en matière de design.

Die Kollektionen unserer QUARRYCAST™ Einbaubecken umfassen moderne und auch traditionelle Stilrichtungen mit flexiblen Einbaumöglichkeiten.

Innerhalb der verschiedenen Größen und Formen finden Sie bestimmt ein Format, das Ihren Designwünschen entspricht. Wählen Sie aus unter runden, ovalen oder rechteckigen Modellen.

La nostra gamma di lavabi QUARRYCAST™ ad incasso include modelli di stilo moderno o tradizionale, con soluzioni flessibili per differenti tipi di installazioni.

Disponibili in diverse dimensioni e forme, troverai sicuramente un formato adatto alle tue esigenze di progettazione; scegli tra stili rotondi, ovali o rettangolari.

Ons assortiment van QUARRYCAST™ wasbakken bevat moderne en klassieke vormen welke op meerdere wijzen kunnen worden geïnstalleerd.

Verkrijgbaar in verschillende maten en vormen, u zult zeker een formaat vinden dat voldoet aan uw ontwerpvereisten; kies uit ronde, ovale of rechthoekige stijlen.

SW
QUARRYCAST™ Blanc
QUARRYCAST™ Weiß.
QUARRYCAST™ Bianco.
QUARRYCAST™ Wit.

Qc rich in
Volcanic
Limestone™



Kaali 46
466 x 353
Page 202

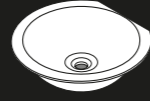

Kaali 48
475 x 453
Page 204

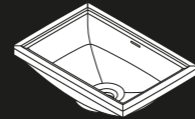

Pembroke 52
512 x 351
Page 218

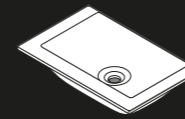

Kaldera 56
560 x 358
Page 210

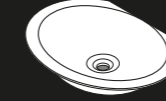

Kaali 60
595 x 447
Page 206

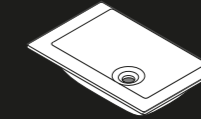

Kaldera 62
610 x 420
Page 212

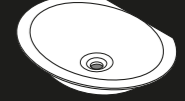

Kaali 65
641 x 466
Page 208

Undermount

✓

✓

✓

✓

✓

✓

✓

Drop-in

✓

Undermount / Encastrement par dessous / Unterbau / Sotto il top / Onderbouw.

Drop-in / Encastrement par dessus / Einbau / A caduta / Inbouw.

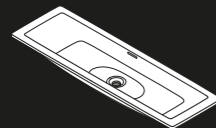

Rossendale 91
916 x 382
Page 220

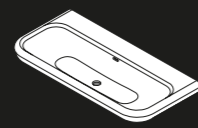

Lario 100 Solo
999 x 479
Page 214

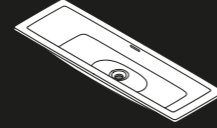

Rossendale 107
1065 x 379
Page 222

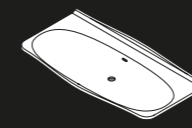

Mandello 114 Solo
1145 x 579
Page 216

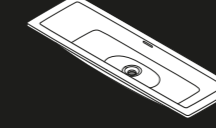

Rossendale 122
1215 x 380
Page 224

Undermount

✓

✓

✓

Drop-in

✓

✓

✓

✓

✓

Undermount / Encastrement par dessous / Unterbau / Sotto il top / Onderbouw.

Drop-in / Encastrement par dessus / Einbau / A caduta / Inbouw.



Kaali 46



○ UB-KAA-46-IO

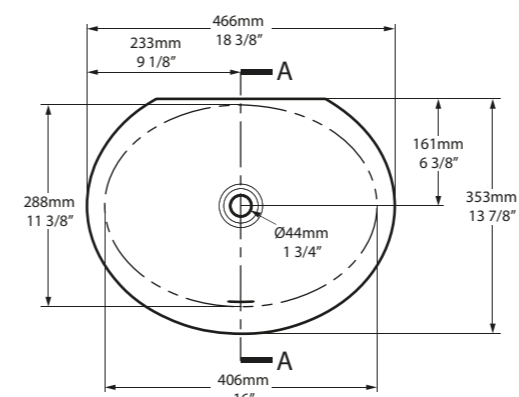

Top View

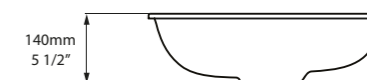

Side View



Front View

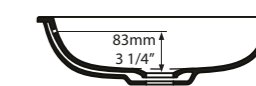

Section AA

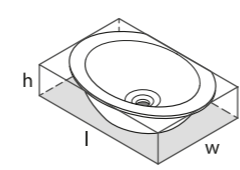
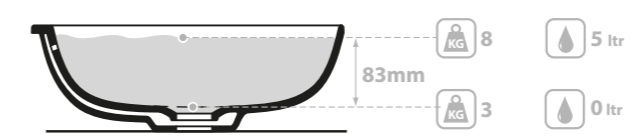

l = 466mm/18 3/8"
w = 353mm/13 7/8"
h = 140mm/5 1/2"

○ UB-KAA-46-IO
3kg



Vasque ovale et profonde à encastrer. La vasque Kaali 46 dispose d'un trou de trop-plein et est désormais disponible dans deux tailles supplémentaires - voir Kaali 60 et Kaali 65. Egalement disponible en format lavabo - voir Metallo 61 Quartz.

Ein tiefes, ovales Waschbecken für den Unterbau. Kaali 46 besitzt einen integrierten Überlauf und ist nun in 2 weiteren Größen erhältlich - siehe Kaali 60 und Kaali 65. Auch erhältlich als Waschtisch mit Metallständer - siehe Metallo 61 Quartz.

Un lavabo ovale profondo progettato per un'installazione sottopiano a scelta. Il Kaali 46 è dotato di un troppopieno interno ed è ora disponibile in due dimensioni supplementari - vedi Kaali 60 e Kaali 65. Disponibile anche in formato lava mani-vedi Metallo 61 Quartz.

Een diep ovale wasbak ontworpen voor onderbouwmontage. De Kaali 46 heeft een interne overloop en is nu verkrijgbaar in twee extra maten - zie Kaali 60 en Kaali 65. Ook verkrijgbaar in wastafelformaat - zie Metallo 61 Quartz.

SW QUARRYCAST™ Blanc
QUARRYCAST™ Weiß.
QUARRYCAST™ Bianco.
QUARRYCAST™ Wit.





Kaali 48

○ UB-KAA-48-IO 

CE  Massachusetts Code
cUPC listing by IAPMO

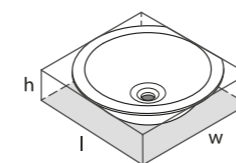
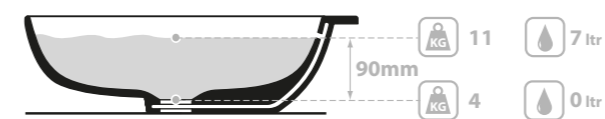
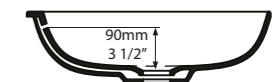
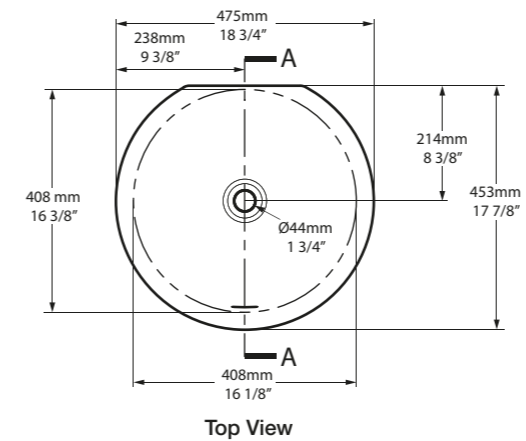

l = 475mm/18¾"
w = 453mm/17⅞"
h = 136mm/5⅜"

○ UB-KAA-48-IO
4kg



Toute en rondeur, la nouvelle vasque Kaali 48 convient parfaitement aux salles de bains contemporaines ou traditionnelles. Comme tous les modèles de la collection Kaali, elle a été conçue pour être encastrée et dispose d'un trou de trop-plein. Voir aussi le plus petit modèle : Kaali 46, ou le plus grand : Kaali 60.

Mit seiner runden Form eignet sich das neue Kaali 48 Waschbecken sowohl für moderne als auch für traditionelle Badezimmer. Wie alle Modelle der Kaali-Kollektion wurde es für den Unterbau konzipiert und besitzt einen integrierten Überlauf. Beachten Sie auch das kleinere Becken Kaali 46 oder das größere Kaali 65.

Di forma rotonda, il nuovo lavabo Kaali 48 si adatta perfettamente ai bagni contemporanei o tradizionali. Come tutti i modelli della collezione Kaali, è progettato per applicazioni sottopiano e presenta un troppopieno interno. Vedi anche i piccoli Kaali 46 o i più grandi lavabi Kaali 60.

De nieuwe Kaali 48-wasbak is rond van vorm en is zeer geschikt voor moderne of traditionele badkamers. Zoals alle modellen in de Kaali-collectie, is het ontworpen voor onderbouw toepassingen en beschikt het over een interne overloop. Zie ook de kleinere Kaali 46 of de grotere Kaali 60-wasbak.

SW QUARRYCAST™ Blanc
QUARRYCAST™ Weiß.
QUARRYCAST™ Bianco.
QUARRYCAST™ Wit.

QC rich in
Volcanic
Limestone™



Kaali 60



○ UB-KAA-60-IO

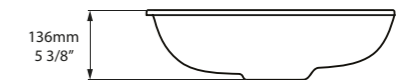
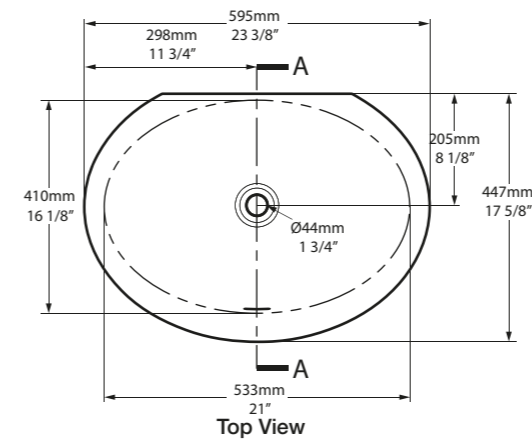

Side View



Front View

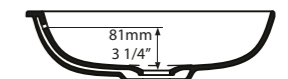

Section AA

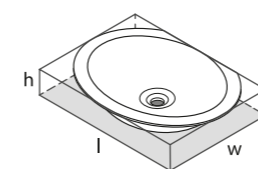
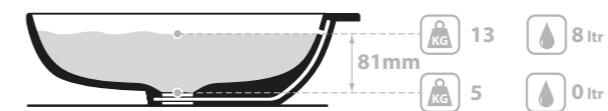

l = 595mm/23 3/8"
w = 447mm/17 5/8"
h = 136mm/5 3/8"

○ UB-KAA-60-IO
5kg



Avec sa forme ovale, la nouvelle vasque à encastrer Kaali 60 suit le même design que la vasque Kaali 46 mais en version plus large. Disponible également dans deux autres formats - voir le plus petit Kaali 46 et le plus grand, Kaali 65.

Mit seiner ovalen Form folgt das Becken Kaali 60 (mit versenktem Rand) der gleichen Ästhetik wie Kaali 46, nur in größeren Abmessungen. In zwei weiteren Größen erhältlich - siehe die kleinere Kaali 46 und die größere Kaali 65.

Di forma ovale, il nuovo lavabo su piano Kaali 60 segue lo stesso design estetico del Kaali 46 ma è di dimensioni maggiori. Disponibile in altre due misure - vedi il più piccolo Kaali 46 e il più grande Kaali 65.

De nieuwe Kaali 60-wasbak is ovaal van vorm en volgt dezelfde ontwerpethiek als de Kaali 46, maar is groter van formaat. Verkrijgbaar in twee andere maten - zie de kleinere Kaali 46 en de grotere Kaali 65.

SW QUARRYCAST™ Blanc
QUARRYCAST™ Weiß
QUARRYCAST™ Bianco
QUARRYCAST™ Wit.





Kaali 65



○ UB-KAA-65-IO

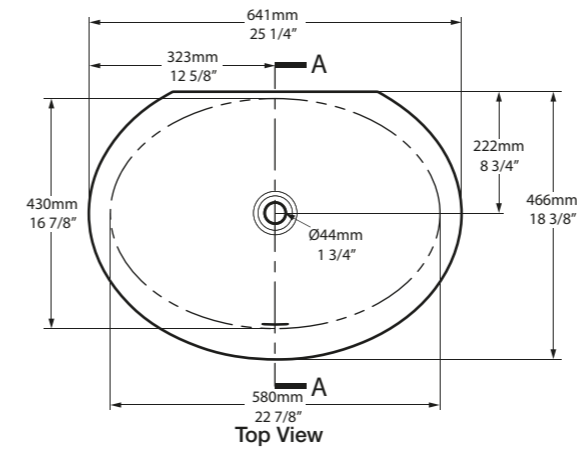

Side View



Front View

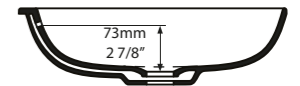

Section AA

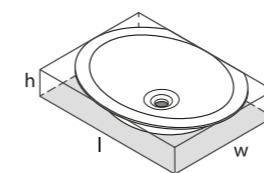
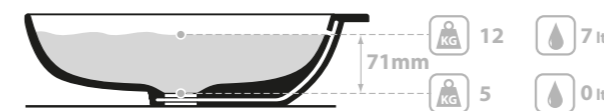

l = 641mm/25 1/4"
w = 466mm/18 3/8"
h = 132mm/5 1/4"

○ UB-KAA-65-IO
5kg



Kaali 65 est la plus généreuse de nos vasques ovales de la collection Kaali ; elle est adaptée à la pose encastrée. Dispose d'un trou de trop-plein. Egalement disponible dans deux formats plus petits - voir Kaali 46 et Kaali 60.

Il Kaali 65 è il più generoso dei nostri lavabi Kaali di forma ovale ed è progettato per installazioni sottopiano. Dispone di un troppopieno interno. Disponibile anche in due taglie più piccole - vedi Kaali 46 e Kaali 60.

Kaali 65 (mit versenktem Rand) ist das größte Modell der Kaali-Kollektion. Mit integriertem Überlauf. Auch erhältlich in zwei kleineren Abmessungen - siehe Kaali 46 und Kaali 60.

De Kaali 65 is de meest genereuze van onze ovaalvormige Kaali-wasbakken en is ontworpen voor onderbouw installaties. Beschikt over een interne overloop. Ook verkrijgbaar in twee kleinere maten - zie Kaali 46 en Kaali 60.

SW QUARRYCAST™ Blanc
QUARRYCAST™ Weiß.
QUARRYCAST™ Bianco.
QUARRYCAST™ Wit.





Kaldera 56

○ UB-KAL-56-IO 

CE  Massachusetts Code
cUPC listing by IAPMO

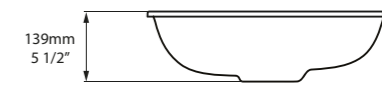
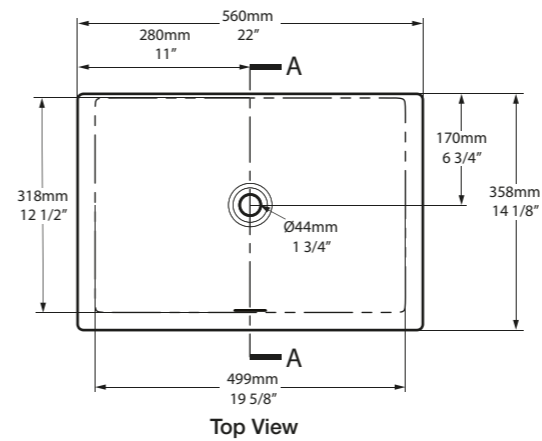

Side View

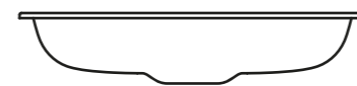

Front View

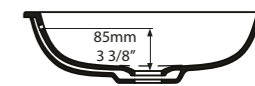

Section AA

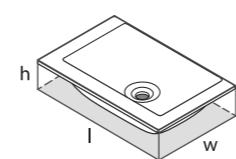
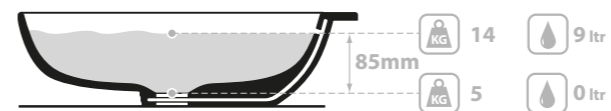

l = 560mm/22"
w = 358mm/14 1/8"
h = 139mm/5 1/2"

○ UB-KAL-56-IO
5kg



Kaldera 56 est une vasque rectangulaire simple conçue pour compléter la baignoire encastrée de la collection Kaldera. Adaptée à la pose encastrée, la vasque Kaldera 56 dispose d'un trou de trop-plein et est aussi disponible dans un plus grand format - voir Kaldera 62.

Kaldera 56 ist ein schlichtes, rechteckiges Waschbecken, passend zur Kollektion der Kaldera Einbauwannen. Geeignet für den Unterbau. Mit integriertem Überlauf. Für ein größeres Format siehe Kaldera 62.

Il lavabo Kaldera 56 è semplice lavabo rettangolare progettato per abbinarsi alla collezione di vasche da bagno ad incasso Kaldera. Adatto per l'installazione sottopiano, il Kaldera 56 presenta un troppopieno interno ed è disponibile anche in dimensioni maggiori - vedi Kaldera 62.

De Kaldera 56 is een eenvoudige rechthoekige wasbak dat is ontworpen passend bij de inbouw badencollectie van Kaldera. Geschikt voor onderbouwinstallatie beschikt het over een interne overloop en is ook verkrijgbaar in een groter formaat - zie Kaldera 62.

SW QUARRYCAST™ Blanc
QUARRYCAST™ Weiß.
QUARRYCAST™ Bianco.
QUARRYCAST™ Wit.

QC rich in
Volcanic
Limestone™



Kaldera 62

○ UB-KAL-62-IO 

CE  Massachusetts Code
cUPC listing by IAPMO

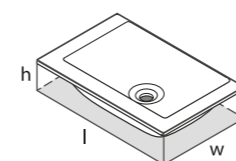
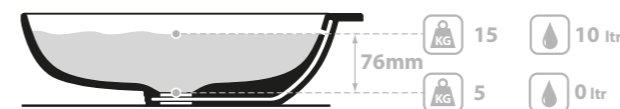
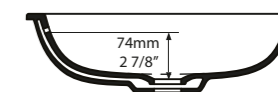
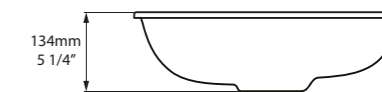
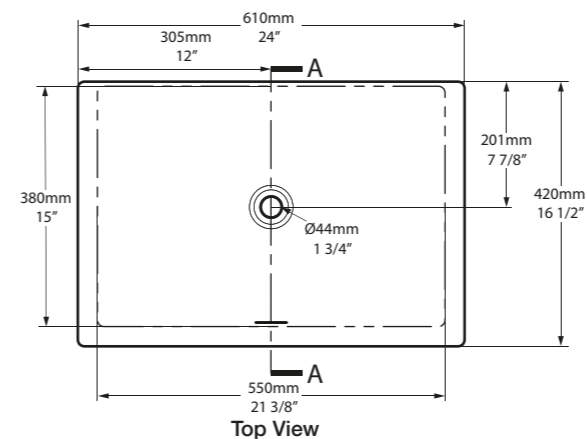

l = 610mm/24"
w = 420mm/16 1/2"
h = 134mm/5 1/4"

○ UB-KAL-62-IO
5kg



Kaldera 62 est la plus grande des vasques à encastrer de la collection Kaldera. De forme rectangulaire, elle a été conçue pour compléter la baignoire encastrée de la collection Kaldera mais peut aussi bien se marier à d'autres modèles. Dispose d'un trou de trop-plein. Egalement disponible dans un plus petit format - voir Kaldera 56.

Kaldera 62 ist das größte Einsatzbecken der Kaldera-Kollektion. Mit seiner rechteckigen Form passt es perfekt zur Kollektion der Kaldera Einbauwannen, lässt sich aber auch gut mit anderen Modellen kombinieren. Mit integriertem Überlauf. Auch in kleinerem Format erhältlich - siehe Kaldera 56.

Il Kaldera 62 è il più grande dei lavabi sottopiano Kaldera. Di forma rettangolare, è progettato per abbinarsi alla collezione di vasche da bagno Kaldera, ma si integra naturalmente con altri modelli. Dispone di un troppopieno interno. Disponibile anche in una dimensione più piccola - vedi Kaldera 56.

De Kaldera 62 is de grootste van de Kaldera onderbouwwasbakken. Het heeft een rechthoekige vorm en is ontworpen om te passen bij de inbouwbaden collectie van Kaldera, maar is natuurlijk ook een aanvulling op andere modellen. Beschikt over een interne overloop. Ook verkrijgbaar in een kleiner formaat - zie Kaldera 56.

SW QUARRYCAST™ Blanc
QUARRYCAST™ Weiß.
QUARRYCAST™ Bianco.
QUARRYCAST™ Wit.

QC rich in
Volcanic
Limestone™



Une vasque traditionnelle dotée d'un rebord délicat, adaptée à la pose sur plan ou semi-encastée. Possède un trou de trop-plein. Conçue par Meneghello Paoletti Associati.

Ein traditionell gestaltetes Becken mit feinen Randverzierungen, das als Aufsatzwaschbecken oder halb versenkt eingebaut werden kann. Mit internem Überlauf. Designed von Meneghello Paoletti Associati.

Un lavabo tradizionale con bordo sottile a dettaglio che può essere montato ad appoggio o a semi incasso. Caratterizzato da un troppopieno interno. Progettato da Meneghello Paoletti Associati.

Een traditionele wastafel met subtiële rand detaillering, voor opzetinstallatie of half verzonken. Inclusief geïntegreerde overloop. Ontwerp van Meneghello Paoletti Associati.

Lario 100 Solo

○ DB-LAR-N-100-IO DB-LAR-1TH-100-IO DB-LAR-3TH-100-IO 

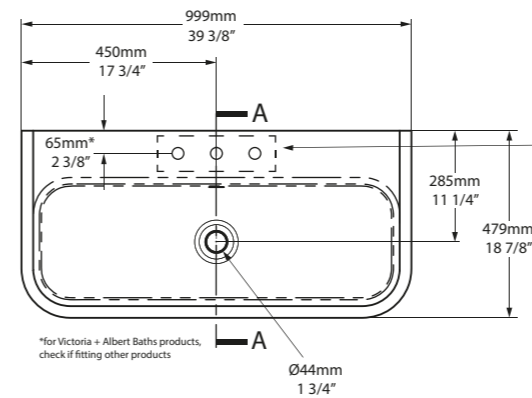

Top View

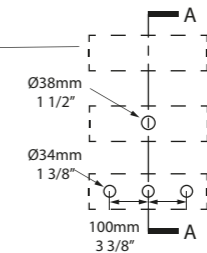

DB-LAR-N-100-IO

DB-LAR-1TH-100-IO

DB-LAR-3TH-100-IO



Front View



Side View

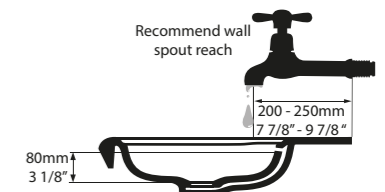

Section AA

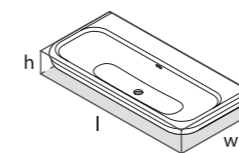

l = 999mm/39 3/8"
w = 479mm/18 7/8"
h = 135mm/5 3/8"

○ DB-LAR-N-100-IO
○ DB-LAR-1TH-100-IO
○ DB-LAR-3TH-100-IO
18kg



SW QUARRYCAST™ Blanc
QUARRYCAST™ Weiß
QUARRYCAST™ Bianco
QUARRYCAST™ Wit.





Mandello 114 Solo

○ DB-MAN-N-114-IO DB-MAN-1TH-114-IO DB-MAN-3TH-114-IO

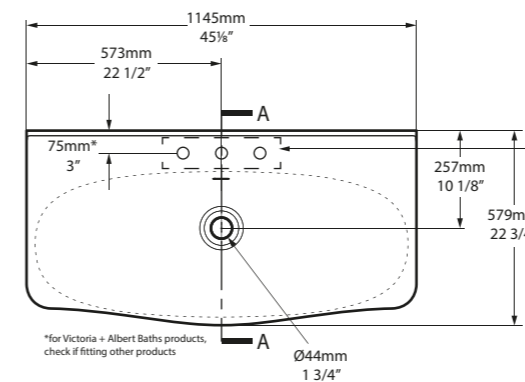

Top View

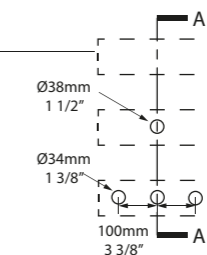

DB-MAN-N-114-IO
DB-MAN-1TH-114-IO
DB-MAN-3TH-114-IO



Front View

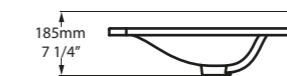

Side View

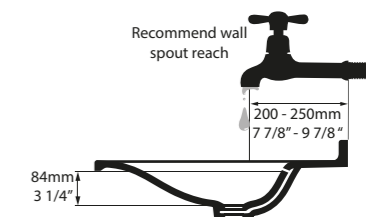

Section AA

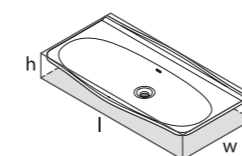
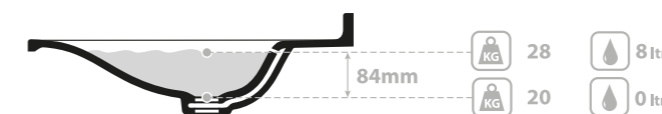

l = 1145mm/45 1/8"
w = 579mm/22 3/4"
h = 185mm/7 1/4"

○ DB-MAN-N-114-IO
○ DB-MAN-1TH-114-IO
○ DB-MAN-3TH-114-IO
20kg



Une vasque contemporaine aux lignes élégantes adaptée à la pose sur plan ou semi-encastée. Possède un trou de trop-plein. Conçue par Meneghello Paoletti Associati.

Ein modernes Becken mit eleganten Linien, das als Aufsatzwaschbecken oder halb versenkt eingebaut werden kann. Mit internem Überlauf. Designed von Meneghello Paoletti Associati.

Un lavabo contemporaneo dalle linee eleganti che può essere montato ad appoggio o semi incasso. Caratterizzato da un troppopieno interno. Progettato da Meneghello Paoletti Associati

Een eigentijdse wastafel met elegante lijnen voor opzetinstallatie of half verzonken. Inclusief egïntegreerde overloop. Onwerp van Meneghello Paoletti Associati.

SW QUARRYCAST™ Blanc
QUARRYCAST™ Weiß,
QUARRYCAST™ Bianco,
QUARRYCAST™ Wit.





Elegante vasque avec bordure et trop-plein intégré. Dispose d'un design caractérisé par un rebord spécial qui permet une installation sur le plan ou encastrée, au choix. Conçue par Meneghello Paoletti Associati.

Waschbecken mit elegantem Rand und integriertem Überlauf. Der speziell gestaltete Rand erlaubt für sowohl Unterbau oder Einbau Installation in eine Oberfläche Ihrer Wahl. Designed von Meneghello Paoletti Associati.

Elegante lavabo con bordo con troppopieno interno. Presenta un design speciale del bordo che permette un'installazione a scelta di piano. Progettato da Meneghello Paoletti Associati.

Elegante wasbak met geïntegreerde overloop. Geschikt voor inbouw alsook onderbouw installaties naar keuze. Ontworpen door Meneghello Paoletti Associati.

Pembroke 52

○ DU-PEM-52-IO 

CE  Massachusetts Code
cUPC listing by IAPMO

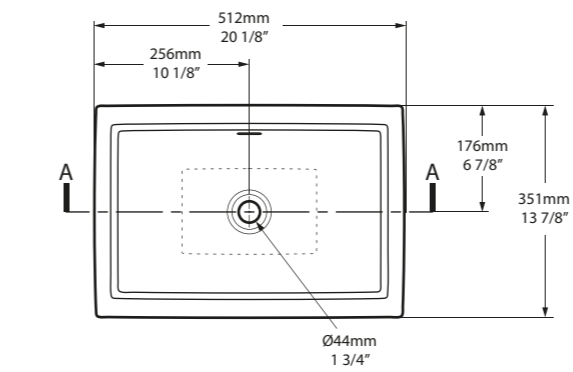

Top View

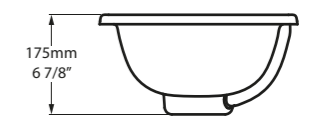

Side View

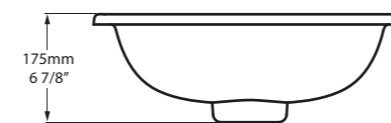

Front View

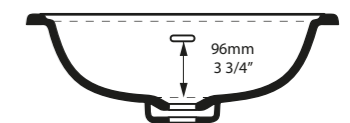
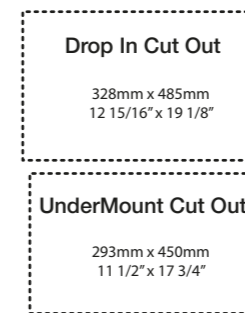

Section AA

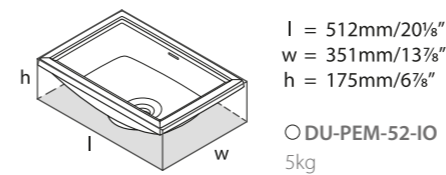
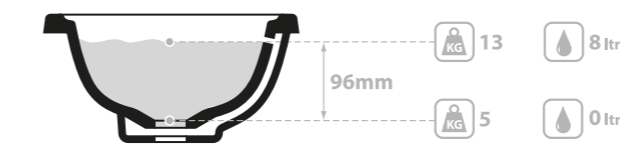

SW QUARRYCAST™ Blanc
QUARRYCAST™ Weiß.
QUARRYCAST™ Bianco.
QUARRYCAST™ Wit.

QC rich in
Volcanic
Limestone™



Rossendale 91

○ DU-ROS-91-IO 

CE  Massachusetts Code
cUPC listing by IAPMO

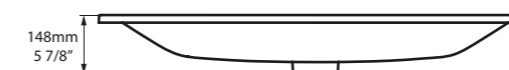
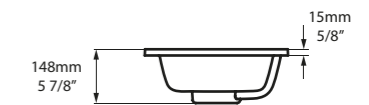
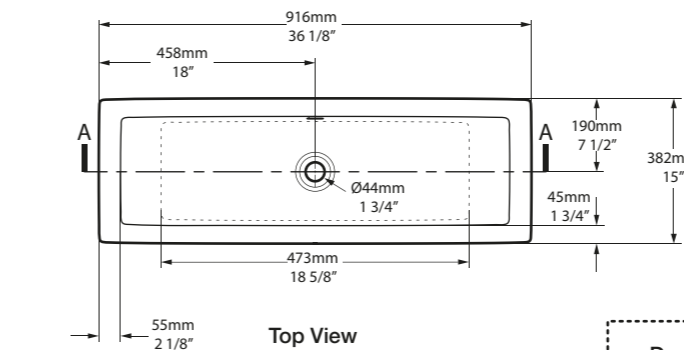

Drop In Cut Out
833mm x 340mm
32 3/4" x 13 3/8"

UnderMount Cut Out
779mm x 274mm
30 5/8" x 10 3/4"

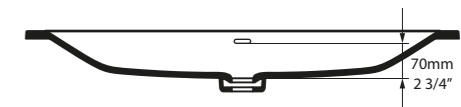

Front View

Section AA

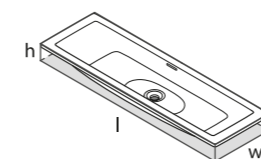
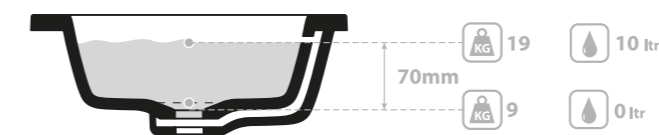

l = 916mm/36 1/8"
w = 382mm/15"
h = 148mm/5 7/8"

○ DU-ROS-91-IO
9kg



La plus petite vasque de la collection Rossendale. Grande, peu profonde, elle est adaptée à la pose encastrée ou sous plan. Possède un trou de trop-plein. Disponible en trois dimensions - voir également Rossendale 107 et Rossendale 122.

Das kleinste unserer Rossendale Waschbecken. Ein langes, flaches Becken zur versenkten Installation, oder zum Unterbau. Mit internem Überlauf. Erhältlich in 3 Größen. Beachten Sie auch Rossendale 107 und Rossendale 122.

Il più piccolo dei nostri lavabi Rossendale. Un lavabo lungo che può essere incassato o montato sotto. Dispone di un troppopieno interno. Disponibile in tre formati-vedi inoltre Rossendale 107 e Rossendale 122.

De kleinste van onze Rossendale wasbakken. Een lange, ondiepe wasbak voor inbouw of onderbouw met geïntegreerde overloop. Verkrijgbaar in drie maten - zie ook Rossendale 107 en Rossendale 122.

SW QUARRYCAST™ Blanc
QUARRYCAST™ Weiß.
QUARRYCAST™ Bianco.
QUARRYCAST™ Wit.

QC rich in
Volcanic
Limestone™



Rosendale 107

○ DU-ROS-107-IO 

CE  Massachusetts Code cUPC listing by IAPMO

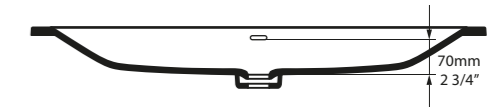
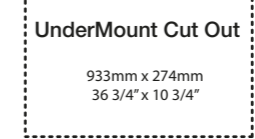
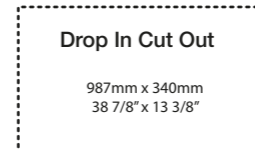
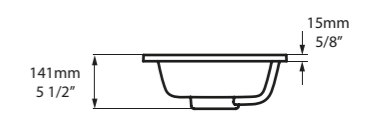
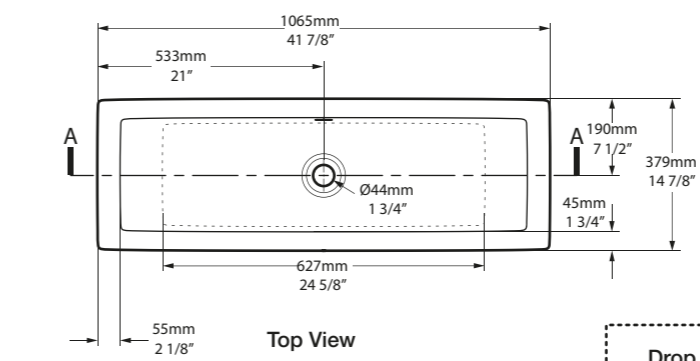

Front View

Section AA

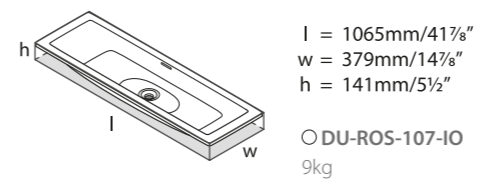
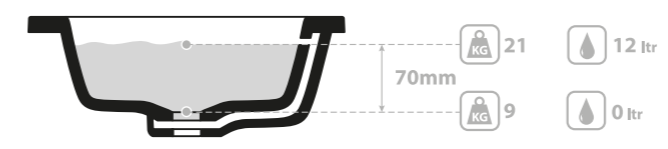

Grande vasque, peu profonde, adaptée à la pose encastrée ou sous-plan. Possède un trou de trop-plein. Disponible en trois dimensions - voir également Rosendale 91 et Rosendale 122.

Ein langes, flaches Becken zur versenkten Installation, oder zum Unterbau. Mit internem Überlauf. Erhältlich in 3 Größen. Beachten Sie auch Rosendale 91 und Rosendale 122.

Un lavabo lungo che può essere incassato o montato sotto. Dispone di un troppopieno interno. Disponibile in tre formati-vedi inoltre Rosendale 91 e Rosendale 122.

Een lange, ondiepe wasbak voor inbouw of onderbouw met geïntegreerde overloop. Verkrijgbaar in drie maten - zie ook Rosendale 91 en Rosendale 122.

SW QUARRYCAST™ Blanc
QUARRYCAST™ Weiß.
QUARRYCAST™ Bianco.
QUARRYCAST™ Wit.

QC rich in Volcanic Limestone™



Rossendale 122



○ DU-ROS-122-IO

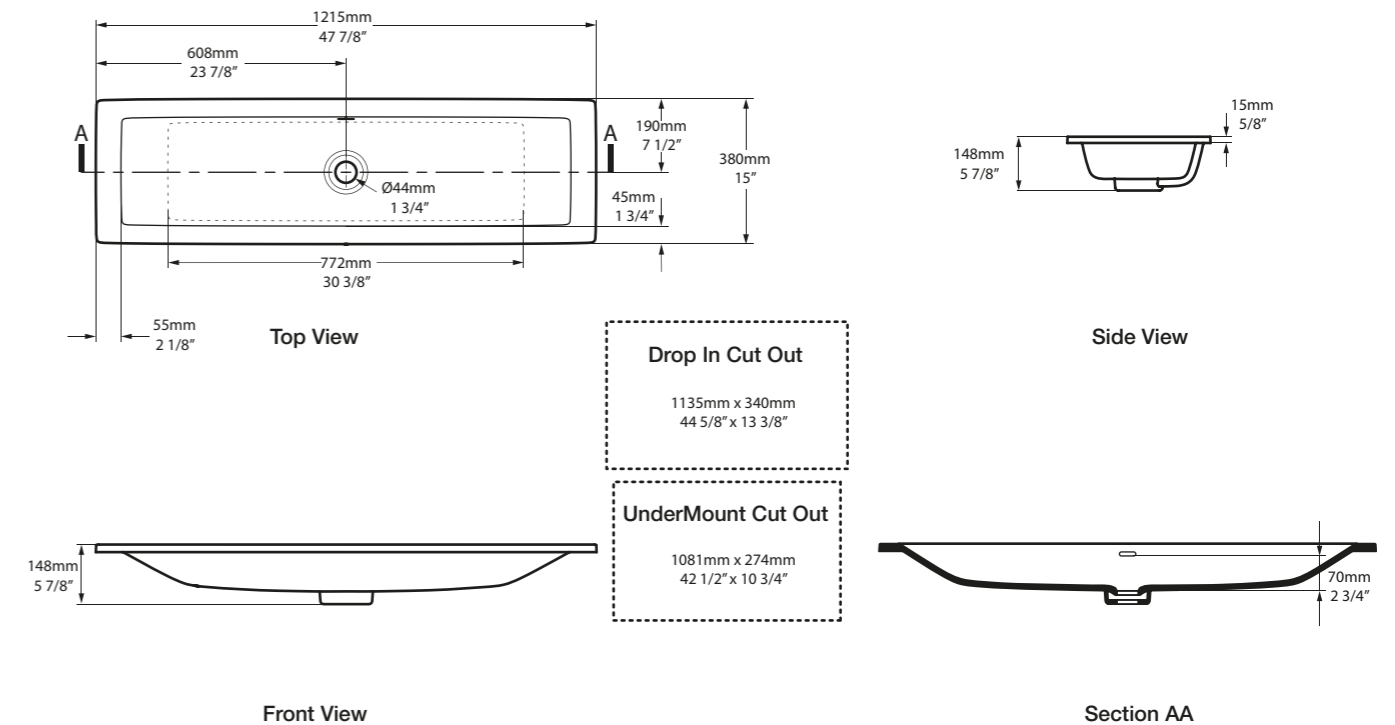

La plus généreuse vasque de la collection Rossendale. Grande mais peu profonde elle est adaptée à la pose encastrée ou sous plan. Possède un trou de trop-plein. Disponible en trois dimensions - voir également Rossendale 91 et Rossendale 107.

Das größte unserer Rossendale Waschbecken. Ein langes, flaches Becken zur versenkten Installation, oder zum Unterbau. Mit internem Überlauf. Erhältlich in 3 Größen. Beachten Sie auch Rossendale 91 und Rossendale 107.

Il più grande dei nostri lavabi Rossendale. Un lavabo lungo che può essere incassato o montato sotto. Dispone di un troppopieno interno. Disponibile in tre formati-vedi inoltre Rossendale 91 e Rossendale 107.

De grootste van onze Rossendale wasbakken. Een lange, ondiepe wasbak voor inbouw of onderbouw met geïntegreerde overloop. Verkrijgbaar in drie maten - zie ook Rossendale 91 en Rossendale 107.

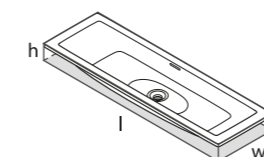
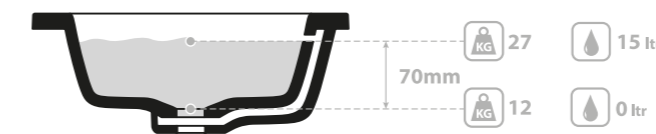

l = 1215mm/47 7/8"
w = 380mm/15"
h = 148mm/5 7/8"

○ DU-ROS-122-IO
12kg



SW
QUARRYCAST™ Blanc
QUARRYCAST™ Weiß.
QUARRYCAST™ Bianco.
QUARRYCAST™ Wit.



Washstands

Nos lavabos s'accordent parfaitement aux intérieurs modernes ou traditionnels.

Choisissez entre deux styles : Candella, de style néoclassique, avec ses pieds délicatement enroulés ou Metallo, de style édouardien, avec ses détails profilés distinctifs. Découvrez les différentes options de vasques, incluant une étonnante surface en Quartz avec vasque encastrée ou l'une de nos généreuses vasques Solo. Cette collection a été conçue par Meneghello Paoletti Associati.

Unsere Waschbeckenständer passen perfekt zu modernen und traditionellen Möbeln.

Wählen Sie zwischen 2 Stilen: Den neoklassizistischen Candella, mit seinen zart gewendelten Füßen, oder dem edwardianischen Metallo, mit dem charakteristischen Gelenken. Erkunden Sie die verschiedenen Waschbeckenoptionen, darunter ein eindrucksvolles Quartz Top mit Becken zum Unterbau, oder eines unserer großzügig bemessenen Solo Becken. Diese Kollektion wurde designed von Meneghello Paoletti Associati.

I nostri lavabi sono perfetti per interni moderni o tradizionali.

Scegli tra due stili; il neoclassico Candella con le gambe delicatamente tornite, o il Metallo edwardiano, che presenta dettagli di giuntura distinti. Esplora le diverse opzioni di lavabo, che includono un top in quarzo con un lavabo sottomontato, o uno dei nostri lavabi Solo generosamente proporzionati. Questa collezione è stata progettata da Meneghello Paoletti Associati.

Onze wastafels zijn perfect geschikt voor moderne of klassieke interieurs.

Kies uit twee stijlen; de neoklassieke Candella met subtiele en elegante poten, of de Edwardian Metallo, met kenmerkende verbindingen. Ontdek de verschillende wasafeloptyes, waaronder een opvallende Quartz-wastafelblad met een onderbouw wasbak, of één van onze royaal geproportioneerde Solo-wasbakken. Deze collectie is ontworpen door Meneghello Paoletti Associati.

Mirrors

Nos miroirs Anatolia sont le complément idéal de notre gamme de lavabos.

Unsere Anatolia Spiegel sind die perfekte Ergänzung zu unserem Waschtisch-Sortiment.

I nostri specchi Anatolia sono il completamento perfetto per i nostri lavabi.

Onze Anatolia-spiegels kunnen perfect gecombineerd worden met ons assortiment wastafels.



PC
Chrome Poli.
Chrom Poliert.
Cromo Lucidato.
Chroom Glanzend.



QWH
Chromé & Blanc.
Chrom Poliert & Weiß.
Cromo Lucido & Bianco.
Chroom Glanzend & Wit.



QBK
Chromé & Noir.
Chrom Poliert & Schwarz.
Cromo Lucido & Nero.
Chroom Glanzend & Zwart.



QBT
Chromé & Biscuit.
Chrom Poliert & Biskuit.
Cromo Lucido & Biscotto.
Chroom Glanzend & Biscuit.



BS
Acier Brossé.
Gebürsteter Stahl.
Acciaio Spazzolato.
Geborsteld RVS.



Metallo 61 Quartz
610 x 494
Page 236

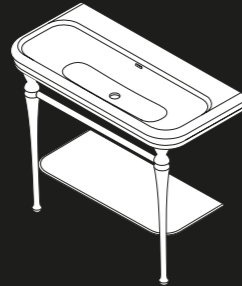

Candella 100
999 x 479
Page 228

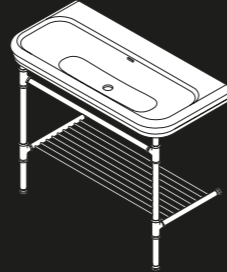

Metallo 100
999 x 479
Page 232



Anatolia 55
638 x 550
Page 240

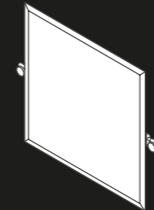

Anatolia 56
652 x 560
Page 242

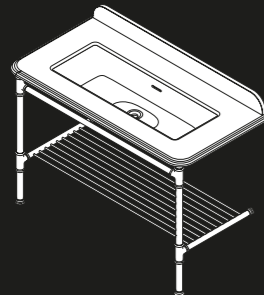

Metallo 113 Quartz
1125 x 515
Page 238

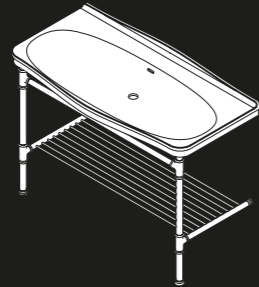

Metallo 114
1145 x 579
Page 234



Candella 114
1145 x 579
Page 230

Candella 100



CAN-100-N-PC CAN-100-1TH-PC CAN-100-3TH-PC

CE UPC Massachusetts Code cUPC listing by IAPMO

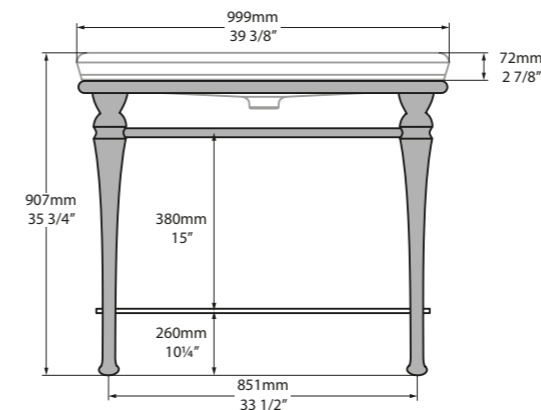

Front view

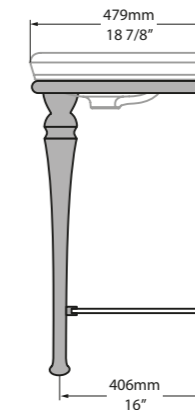

Side view

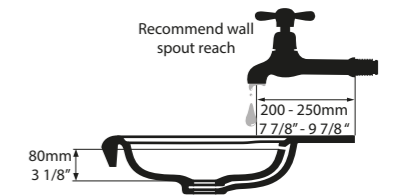

Section AA



Tap holes can be drilled by installer.
Armaturenlöcher können leicht vom Installateur gebohrt werden.
Les trous de robinetterie peuvent être percés par l'installateur.
Pueden ser perforados por el instalador.
I fori per rubinetti possono essere perforati dall'installatore.

CAN-100-N-PC

CAN-100-1TH-PC

CAN-100-3TH-PC

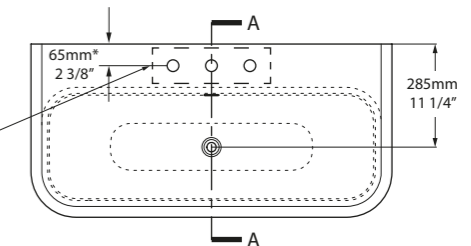
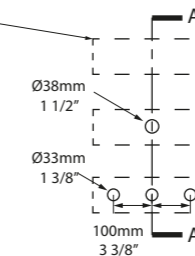

*for Victoria + Albert Baths products, check if fitting other products.

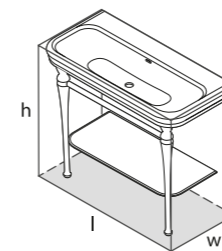

l = 999mm/39 3/8"
w = 479mm/18 7/8"
h = 907mm/35 3/4"

CAN-100-N-PC
CAN-100-1TH-PC
CAN-100-3TH-PC
40.5kg



Lavabo chromé surmonté d'une vasque Lario 100 Solo.

- Possibilité de commander avec ou sans trou de robinetterie;
- Deux pieds aux détails de formes élégantes;
- Porte-serviette et étagère en verre trempé pour le rangement;
- Elements d'ancrage mural inclus.

Waschbeckenständer in poliertem Chrom, mit dem Becken Lario 100 Solo.

- Mit oder ohne Armaturenlöcher erhältlich;
- Zwei Füße mit elegant geschwungenen Details;
- Handtuchhalter und ein Aufbewahrungsregal aus gehärtetem Glas;
- Inklusive Wandbefestigung.

Lavabo in cromo lucido sormontato da un lavabo Lario 100 Solo.

- Opzione per ordinare con o senza fori per rubinetto;
- Due gambe con eleganti dettagli;
- Portasciugamani e un ripiano in vetro temperato;
- Ancoraggi a muro inclusi.

Glans chromen onderstel met de Lario 100 Solo wasbak.

- Optioneel verkrijgbaar met of zonder kraangaten;
- Twee poten met elegant gevormde details;
- Handdoek rail en planchet van gehard glas;
- Muurankers inbegrepen.



CAN-114-N-PC CAN-114-1TH-PC CAN-114-3TH-PC

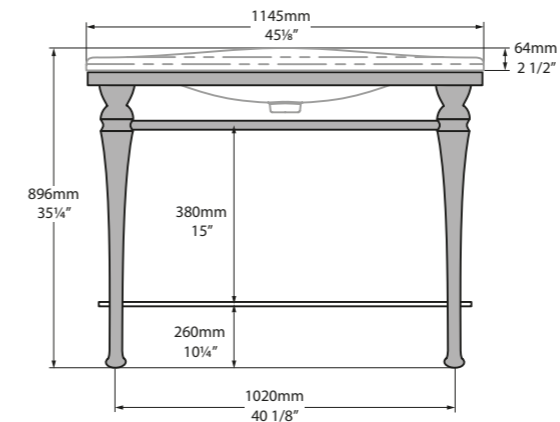

Front view

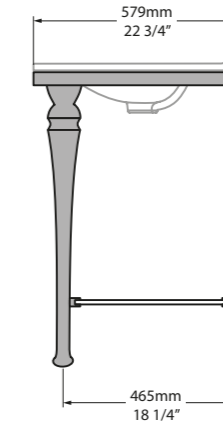

Side view

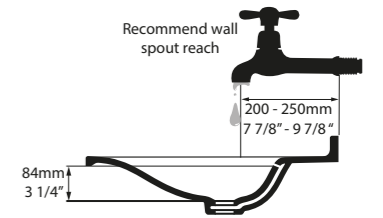

Section AA



Tap holes can be drilled by installer
 Armaturenlöcher können leicht vom Installateur gebohrt werden
 Les trous de robinetterie peuvent être percés par l'installateur
 Pueden ser perforados por el instalador
 I fori per rubinetti possono essere perforati dall'installatore

CAN-114-N-PC

CAN-114-1TH-PC

CAN-114-3TH-PC

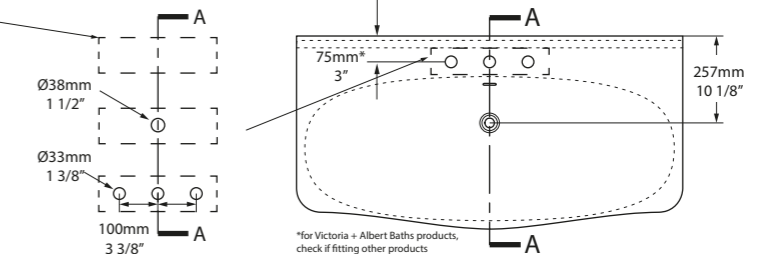

*for Victoria + Albert Baths products, check if fitting other products

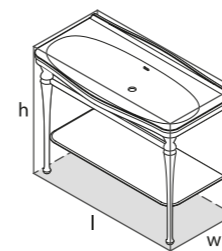

l = 1145mm/45 1/8"
 w = 579mm/22 3/4"
 h = 896mm/35 1/4"

CAN-114-N-PC
 CAN-114-1TH-PC
 CAN-114-3TH-PC
 42.5kg



- Lavabo chromé surmonté d'une vasque Mandello 114 Solo.
- Possibilité de commander avec ou sans trou de robinetterie;
 - Deux pieds aux détails de formes élégantes;
 - Porte-serviette et étagère en verre trempé pour le rangement;
 - Elements d'ancrage mural inclus.

Waschbeckenständer in poliertem Chrom, mit dem Becken Mandello 114 Solo.

- Mit oder ohne Armaturenlöcher erhältlich;
- Zwei Füße mit elegant geschwungenen Details;
- Handtuchhalter und ein Aufbewahrungsregal aus gehärtetem Glas;
- Inklusive Wandbefestigung.

Lavabo in cromo lucido sormontato da un lavabo Mandello 114 Solo.

- Opzione per ordinare con o senza fori per rubinetto;
- Due gambe con eleganti dettagli;
- Portasciugamani e un ripiano in vetro temperato;
- Ancoraggi a muro inclusi.

Glans chromen onderstel met de Mandello 114 Solo wasbak.

- Optioneel verkrijgbaar met of zonder kraangaten;
- Twee poten met elegant gevormde details;
- Handdoek rail en planchet van gehard glas;
- Muurankers inbegrepen.



Metallo 100

MET-100-N-PC MET-100-1TH-PC MET-100-3TH-PC

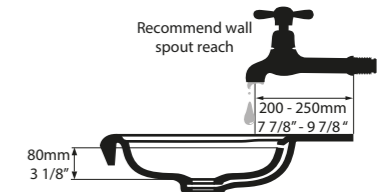
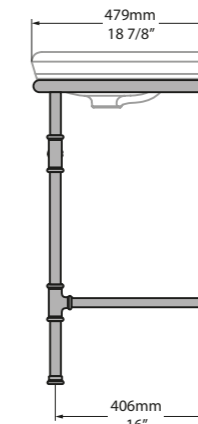
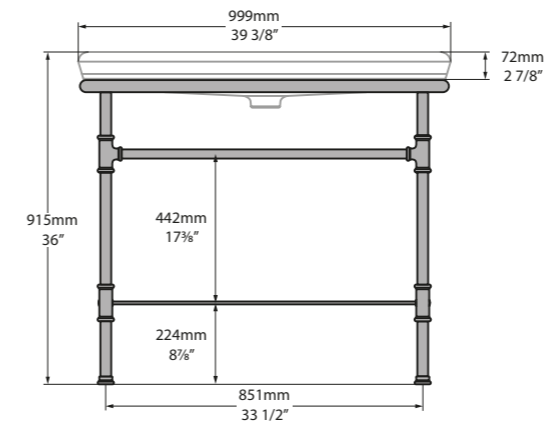

Front view

Side view

Section AA



Tap holes can be drilled by installer
 Armaturenlöcher können leicht vom Installateur gebohrt werden
 Les trous de robinetterie peuvent être percés par l'installateur
 Pueden ser perforados por el instalador
 I fori per rubinetti possono essere perforati dall'installatore

MET-100-N-PC
 MET-100-1TH-PC
 MET-100-3TH-PC

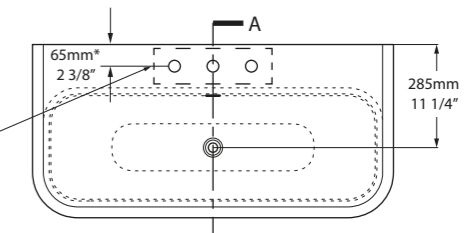
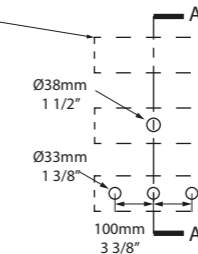

*for Victoria + Albert Baths products, check if fitting other products

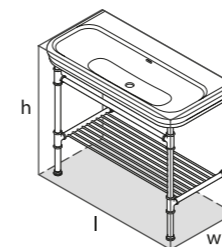

l = 999mm/39 3/8"
 w = 479mm/18 7/8"
 h = 915mm/36"

MET-100-N-xx-IO
 MET-100-1TH-xx-IO
 MET-100-3TH-xx-IO
 33kg



- Lavabo chromé surmonté d'une vasque Lario 100 Solo.
- Possibilité de commander avec ou sans trou de robinetterie;
 - Deux pieds avec finition des jointures en T;
 - Porte-serviette et support pour le rangement;
 - Elements d'ancrage mural inclus.

Waschbeckenständer in poliertem Chrom, mit dem Becken Lario 100 Solo.

- Mit oder ohne Armaturenlöcher erhältlich;
- Zwei Füße mit charakteristischen Gelenken;
- Handtuchhalter und Aufbewahrungsregal;
- Inklusive Wandbefestigung.

- Lavabo in cromo lucido sormontato da un lavabo Lario 100 Solo.
- Opzione per ordinare con o senza fori per rubinetto;
 - Due gambe con dettagli di giunture eleganti;
 - Portasciugamani e un ripiano;
 - Ancoraggi a muro inclusi.

Glans chromen onderstel met de Lario 100 Solo wasbak.

- Optioneel verkrijgbaar met of zonder kraangaten;
- Twee poten met T-stuk verbindingen;
- Handdoek rail en planchet;
- Muurankers inbegrepen.

MET-114-N-PC MET-114-1TH-PC MET-114-3TH-PC

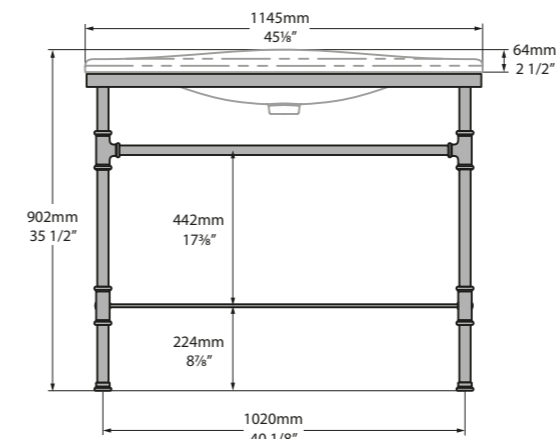

Front view

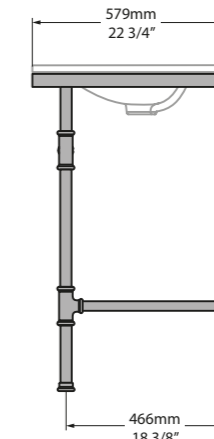

Side view

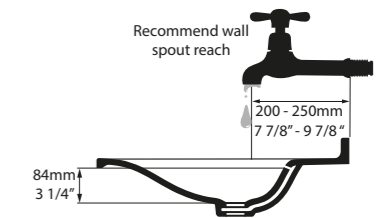

Section AA



Tap holes can be drilled by installer
 Armaturenlöcher können leicht vom Installateur gebohrt werden
 Les trous de robinetterie peuvent être percés par l'installateur
 Pueden ser perforados por el instalador
 I fori per rubinetti possono essere perforati dall'installatore

MET-114-N-PC

MET-114-1TH-PC

MET-114-3TH-PC

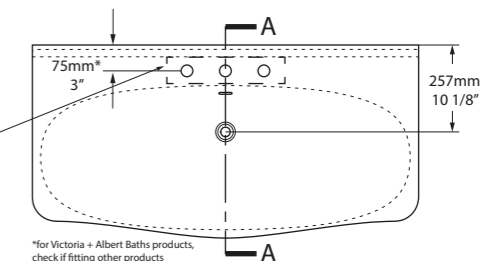
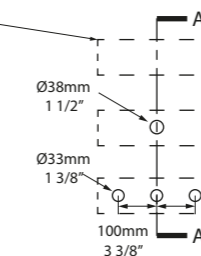

*for Victoria + Albert Baths products, check if fitting other products

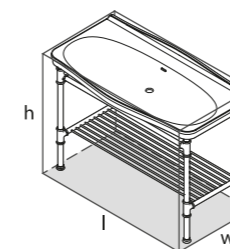

l = 1145mm/45 1/8"
 w = 579mm/22 3/4"
 h = 902mm/35 1/2"

MET-114-N-PC
 MET-114-1TH-PC
 MET-114-3TH-PC
 35kg



Lavabo chromé surmonté d'une vasque Mandello 114 Solo.

- Possibilité de commander avec ou sans trou de robinetterie;
- Deux pieds avec finition des jointures en T;
- Porte-serviette et support pour le rangement;
- Elements d'ancrage mural inclus.

Waschbeckenständer in poliertem Chrom, mit dem Becken Mandello 114 Solo.

- Mit oder ohne Armaturenlöcher erhältlich;
- Zwei Füße mit charakteristischen Gelenken;
- Handtuchhalter und Aufbewahrungsregal;
- Inklusive Wandbefestigung.

Lavabo in cromo lucido sormontato da un lavabo Mandello 114 Solo.

- Opzione per ordinare con o senza fori per rubinetto;
- Due gambe con dettagli di giunture eleganti;
- Portasciugamani e un ripiano;
- Ancoraggi a muro inclusi.

Glans chromen onderstel met de Mandello 114 Solo wasbak.

- Optioneel verkrijgbaar met of zonder kraangaten;
- Twee poten met T-stuk verbindingen;
- Handdoek rail en planchet;
- Muurankers inbegrepen.



MET-61-Qxx-N-PC MET-61-Qxx-1TH-PC MET-61-Qxx-3TH-PC



Massachusetts Code Pending
cUPC listing by IAPMO Pending

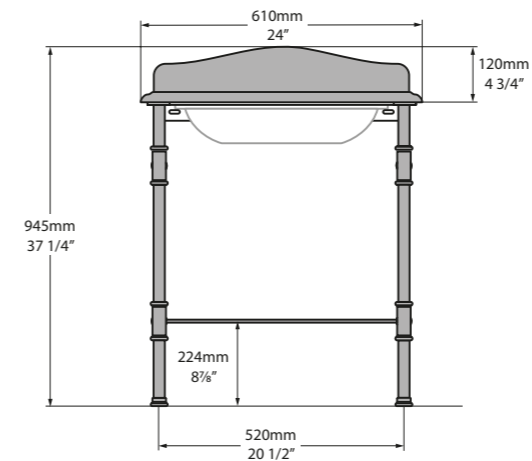

Front view

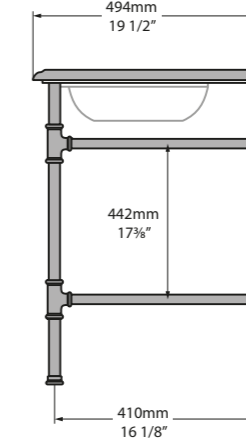

Side view

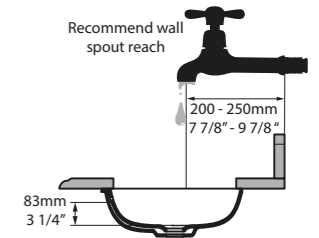

Section AA



Tap holes can be drilled by installer
Armaturenlöcher können leicht vom Installateur gebohrt werden
Les trous de robinetterie peuvent être percés par l'installateur
Pueden ser perforados por el instalador
I fori per rubinetti possono essere perforati dall'installatore

MET-61-Qxx-N-PC

MET-61-Qxx-1TH-PC

MET-61-Qxx-3TH-PC

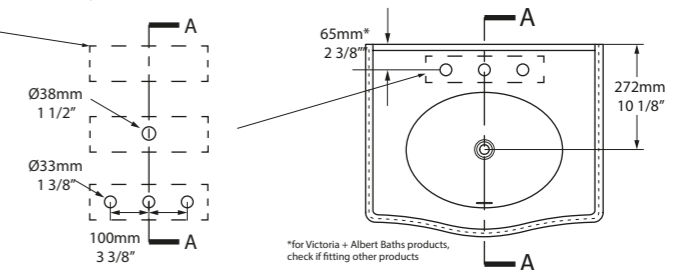

*for Victoria + Albert Baths products,
check if fitting other products

Lavabo avec surface en Quartz et vasque encastrée Kaali 46.

- Au choix : surface en Quartz Blanche, Noire ou Biscuit;
- Crédenca amovible dans le même matériau de finition;
- Possibilité de commander avec ou sans trou de robinetterie;
- Deux pieds chromés avec finition des jointures en T;
- Porte-serviette et support pour le rangement;
- Elements d'ancrage mural inclus.

Waschbeckenständer mit Quartz Top und untermontiertem Waschbecken Kaali 46.

- Quartz Top wahlweise in Weiß, Schwarz oder Biscuit;
- Abnehmbarer Überstand aus dem gleichen Oberflächenmaterial;
- Mit oder ohne Armaturenlöcher erhältlich;
- Zwei Füße aus poliertem Chrom mit markanten T-Stücken;
- Handtuchhalter und Aufbewahrungsregal;
- Inklusive Wandbefestigung.

Lavabo quarzo-sormontato con un lavabo sottomontato Kaali 46.

- Scelta di top in quarzo Bianco, Nero o Biscotto;
- Alzata removibile nella stessa finitura di materiale;
- Opzione per ordinare con o senza fori per rubinetto;
- Due gambe in cromo lucidato con dettagli di giunture eleganti;
- Portasciugamani e un ripiano;
- Ancoraggi a muro inclusi.

Quartz wastafelblad met onderstel, inclusief Kaali 46 onderbouw wasbak.

- Quartz wastafelblad naar keuze in Wit, Zwart of Biscuit;
- Verwijderbare opstand in dezelfde materiaalaafwerking;
- Optioneel verkrijgbaar met of zonder kraangaten;
- Twee glans chromen poten met T-stuk verbindingen;
- Handdoek rail en planket;
- Muurankers inbegrepen.

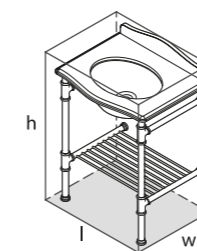

l = 610mm/24"
w = 494mm/19 1/2"
h = 945mm/37 1/4"

MET-61-Qxx-N-PC
MET-61-Qxx-1TH-PC
MET-61-Qxx-3TH-PC
31kg



Metallo 113 Quartz



MET-113-Qxx-N-PC MET-113-Qxx-1TH-PC MET-113-Qxx-3TH-PC

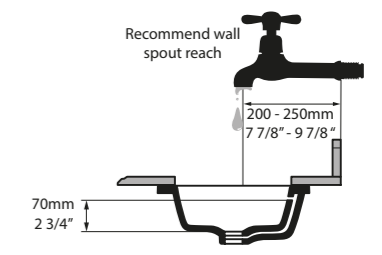
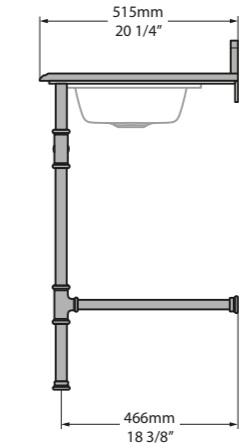
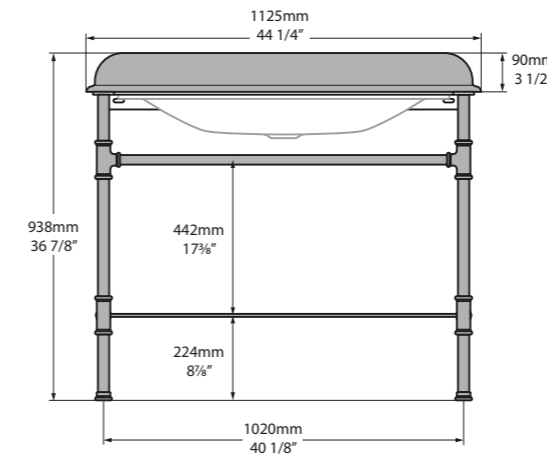

Front view

Side view

Section AA

Tap holes can be drilled by installer
 Armaturenlöcher können leicht vom Installateur gebohrt werden
 Les trous de robinetterie peuvent être percés par l'installateur
 Pueden ser perforados por el instalador
 I fori per rubinetti possono essere perforati dall'installatore

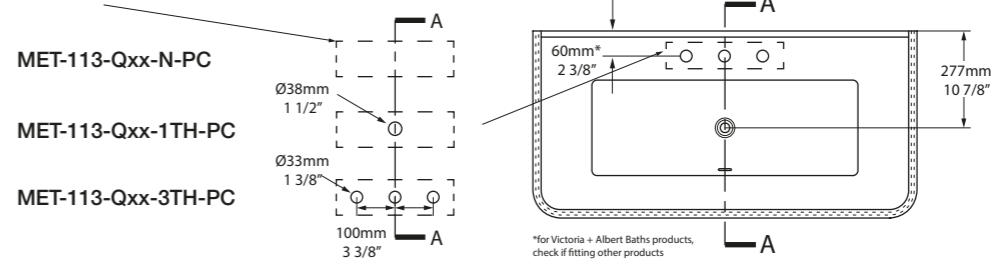

MET-113-Qxx-N-PC

MET-113-Qxx-1TH-PC

MET-113-Qxx-3TH-PC

*for Victoria + Albert Baths products, check if fitting other products

Lavabo avec surface en Quartz et vasque encastrée Rossendale 91.

- Au choix : surface en Quartz Blanche, Noire ou Biscuit;
- Crédence amovible dans le même matériau de finition;
- Possibilité de commander avec ou sans trou de robinetterie;
- Deux pieds chromés avec finition des jointures en T;
- Porte-serviette et support pour le rangement;
- Elements d'ancrage mural inclus.

Waschbeckenständer mit Quartz Top und untermontiertem Waschbecken Rossendale 91.

- Quartz Top wahlweise in Weiß, Schwarz oder Biscuit;
- Abnehmbarer Überstand aus dem gleichen Oberflächenmaterial;
- Mit oder ohne Armaturenlöcher erhältlich;
- Zwei Füße aus poliertem Chrom mit markanten T-Stücken;
- Handtuchhalter und Aufbewahrungsregal;
- Inklusive Wandbefestigung.

Lavabo quarzo-sormontato con un lavabo sottomontato Rossendale 91.

- Scelta di top in quarzo Bianco, Nero o Biscotto;
- Alzata removibile nella stessa finitura di materiale;
- Opzione per ordinare con o senza fori per rubinetto;
- Due gambe in cromo lucidato con dettagli di giunture eleganti;
- Portasciugamani e un ripiano;
- Ancoraggi a muro inclusi.

Quartz wastafelblad met onderstel, inclusief Rossendale 91 onderbouw wasbak.

- Quartz wastafelblad naar keuze in Wit, Zwart of Biscuit;
- Verwijderbare opstand in dezelfde materiaalafwerking;
- Optioneel verkrijgbaar met of zonder kraangaten;
- Twee glans chromen poten met T-stuk verbindingen;
- Handdoek rail en planket;
- Muurankers inbegrepen.

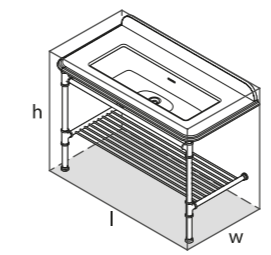

l = 1125mm/44 1/4"
 w = 515mm/20 1/4"
 h = 938mm/36 7/8"

MET-113-Qxx-N-PC
 MET-113-Qxx-1TH-PC
 MET-113-Qxx-3TH-PC
 45kg





Miroir mural rond avec supports pivotants apparents. Disponible en finition Chromé ou Inox brossé.

Runder schwenkbarer Wandspiegel mit sichtbarer Befestigung. Erhältlich in poliertem Chrom oder gebürstetem Edelstahl.

Specchio rotondo a parete con staffe esposte girevoli. Disponibile in finiture Cromo Lucido o Acciaio spazzolato.

Ronde wandspiegel met kantelbare beugels. Verkrijgbaar in Chrom of Roestvrij Staal.

MR-ANA-55-xx

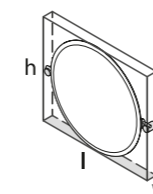
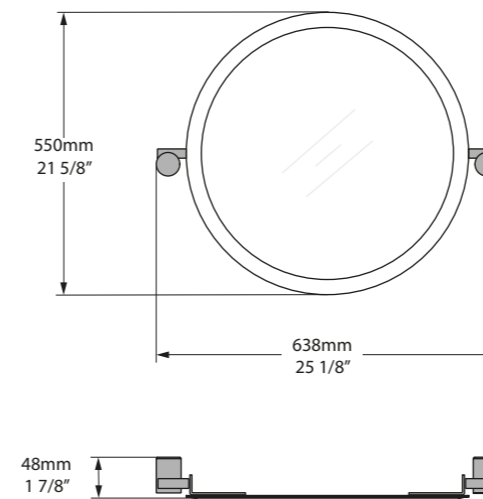

l = 638mm/25 1/8"
w = 48mm/1 7/8"
h = 550mm/21 5/8"

MR-ANA-55-xx
3kg





MR-ANA-56-xx

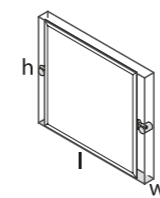
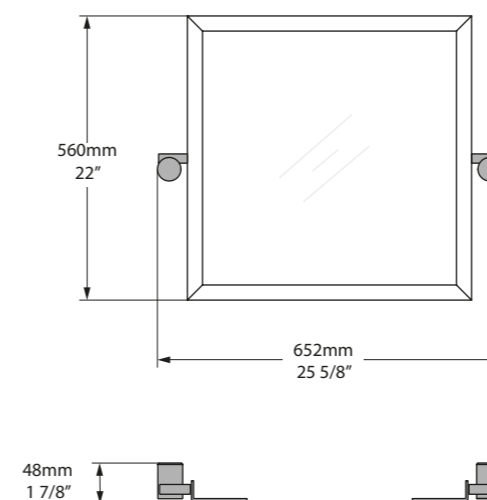

l = 652mm/25 5/8"
w = 48mm/1 7/8"
h = 560mm/22"

MR-ANA-56-xx
4kg



Miroir mural carré avec supports pivotants apparents. Disponible en finition Chromé ou en Inox brossé.

Viereckiger schwenkbarer Wandspiegel mit sichtbarer Befestigung. Erhältlich in poliertem Chrom oder gebürstetem Edelstahl.

Specchio quadrato a parete con staffe a vista girevoli. Disponibile in finitura Cromo Lucido o Acciaio spazzolato.

Vierkante wandspiegel met kantelbare beugels. Verkrijgbaar in Chrom of Roestvrij Staal.

Waste kits

Que vous recherchez des systèmes d'évacuation pour baignoire ou pour vasque ou encore des siphons, nous disposons de nombreuses options pour répondre à vos besoins en termes d'installation. Choisissez parmi toute une variété de finitions pour donner un style harmonieux à votre salle de bains.

Ob Sie Badewannenabflüsse, Waschbeckenabflüsse oder Flaschensiphons suchen: Wir bieten Ihnen eine Vielzahl an Optionen. Profitieren Sie von unserem Angebot an unterschiedlichsten Oberflächen, um Ihrem Badezimmer einen harmonischen Look zu verleihen.

Che tu stia cercando scarichi per la vasca, scarichi per lavabi o sifoni a bottiglia, abbiamo una serie di opzioni per soddisfare le tue esigenze di installazione. Scegli tra una varietà di finiture per creare un look pulito nel tuo bagno.

Of u nu op zoek bent naar bad- of wasbak afvoeren, of sifons, wij hebben een aantal opties om aan uw installatievereisten te voldoen. Kies uit verschillende afwerkingen om een naadloze look in uw badkamer te creëren.



Chrome Poli.
Chrom Poliert.
Cromo Lucidato.
Chroom Glanzend.



Laiton Poli.
Messing Poliert.
Ottone Lucidato.
Messing Glanzend.



Nickel Brossé.
Nickel Gebürstet.
Nickel Spazzolato.
Nickel Geborsteld.



Nickel Poli.
Nickel Poliert.
Nickel Lucidato.
Nickel Glanzend.



Métal Blanc.
Metall Weiß.
Metallo Bianco.
Wit Metalen.



Mat Blanc.
Matt Weiß.
Opaco Bianco.
Mat Metalen.



Noir.
Schwarz.
Nero.
Zwart.



QUARRYCAST™ Blanc
QUARRYCAST™ Weiß.
QUARRYCAST™ Bianco.
QUARRYCAST™ Wit.



QUARRYCAST™ Blanc Mat.
QUARRYCAST™ Standard Matt.
QUARRYCAST™ Standard Opaco.
QUARRYCAST™ Standaard Mat.



BASIN WASTES



Kit 24
Page 246



Kit 25
Page 247

Basin wastes / Vidages pour vasque / Abläufe Waschbecken / Tubature per lavabi / Afvoer wasbak.

BASIN BOTTLE TRAP



Kit 22
Page 248



Kit 122
Page 249

Basin bottle trap / Siphon / Geruchverschluss / Sifone a bottiglia per lavabo / Siphon wasbak.

BATH WASTES



Kit 12
Page 250



Kit 17
Page 251



Kit 30
Page 252



Kit 31
Page 253



Kit 36
Page 254



Kit 40
Page 254



Kit 60
Page 256



Kit 61
Page 257

For installation with overflow
IntelliDrain



Bath wastes / Vidages pour baignoire / Abläufe Wannen / Tubature per vasche / Afvoer baden.
For installation with overflow / Avec trop-plein / Mit Überlauf / Con foro per troppo pieno / Met overloopgat.



Kit 24

Système d'évacuation universel pour vasque avec bonde à clapet rotatif et insert pour écoulement libre.

Waschbecken-Abfluss mit Klappverschluss und freier Abflußoption.

Lavabo a drenaggio universale con tappo prigioniero e inserto a flusso libero.

Universele wasbakafvoer met flip plug en/of free flow insert.



K-24-xx

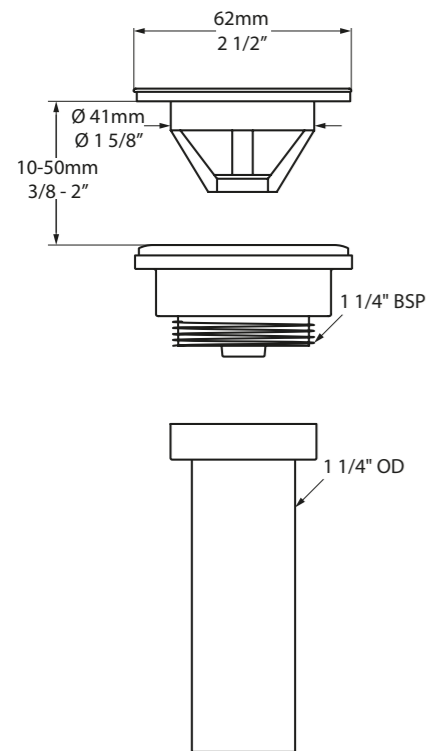

Kit 25

Système d'évacuation universel avec bonde clic-clac pour vasque.

Waschbecken-Ablauf mit Klickverschluss.

Lavabo a drenaggio universale con tappo a clicker.

Universele wasbakafvoer met clicker mechanisme.



K-25-xx

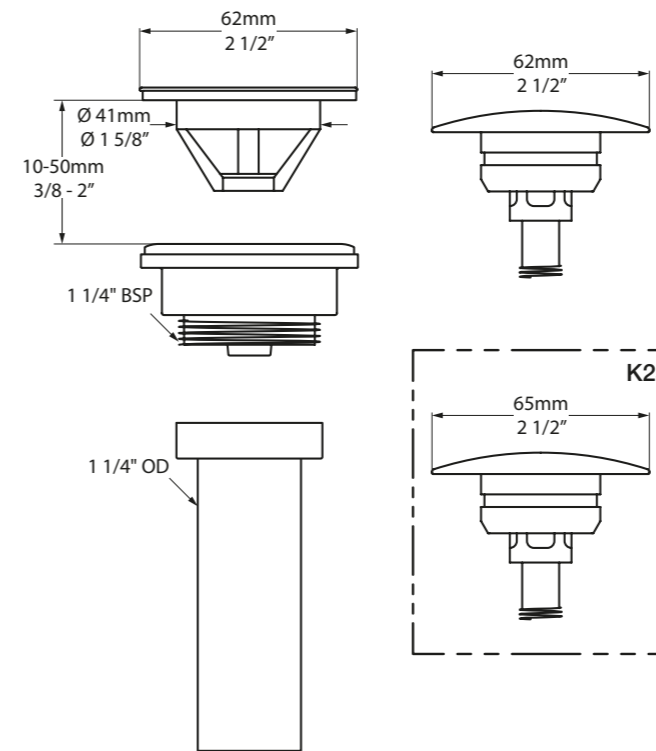



Kit 22

Siphon pour vidages K24/25.

Geruchverschluss für Einsatz mit K24/25.

Sifone a bottiglia per lavabi da usare con K24/25.

Afvoersifon voor gebruik met K24/25.

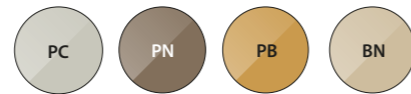

Kit 122

Siphon pour vidages K24/25.

Geruchverschluss für Einsatz mit K24/25.

Sifone a bottiglia per lavabi da usare con K24/25.

Afvoersifon voor gebruik met K24/25.



K-22-xx

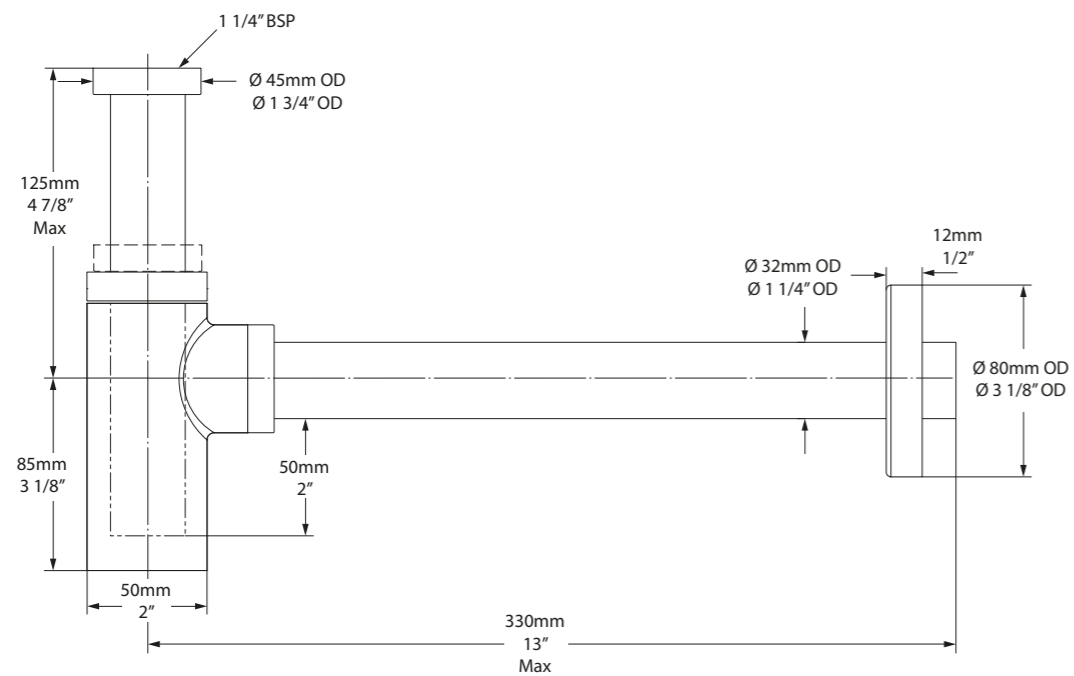

K-122-xx

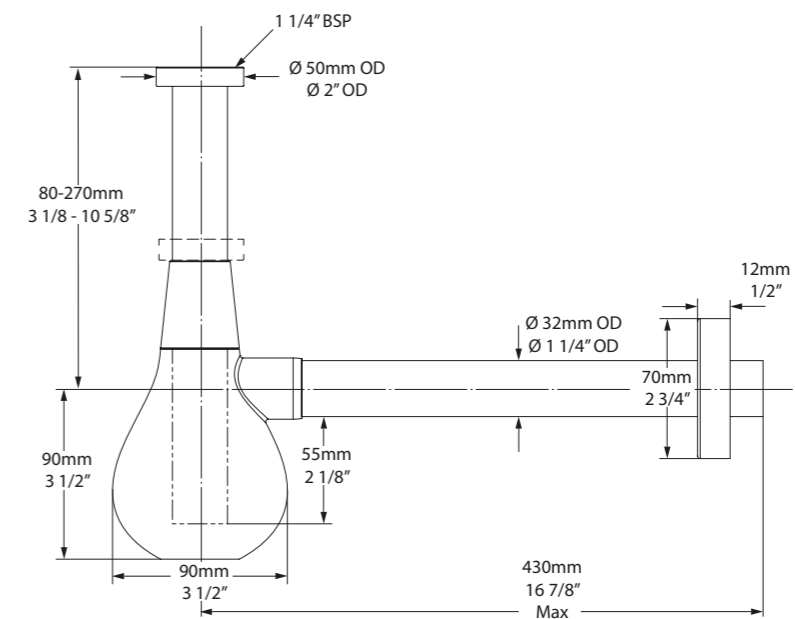



Kit 12

Vidage universel pour baignoires sans trou de trop-plein.
Bonde affleurante pivotante.

Universaler Ablauf für Wannen ohne Überlauf.
Klappverschluss.

Nascosto - Kit universale di scarico per vasche senza foro per troppopieno. Tappo "prigioniero" montato a filo.

Universele afvoer voor baden zonder overloop "Flip" plug.

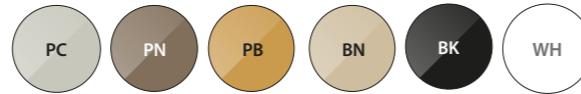

Kit 17

Vidage spécialement adapté aux baignoires sans trop-plein d'usine.
Bonde affleurante pivotante. Le trou de trop-plein peut être percé sur site par votre installateur ou par l'usine moyennant un supplément.

Spezielle Ab- und Überlaufgarnitur. Für Wannen ohne vorgebohrtes Überlaufloch. Das Überlaufloch kann vor Ort von Ihrem Installateur oder vom Werk gegen Aufpreis gebohrt werden.

Sistema di scarico speciale per vasche senza troppopieno pre-perforato. Un troppopieno può essere forato dal installatore, o dal stabilimento ad un ulteriore costo.

Speciale afvoer. Voor baden zonder voorgeboord overloopgat. Overloopgat kan ter plaatse door installateur worden geboord of door de fabriek tegen een meerprijs.

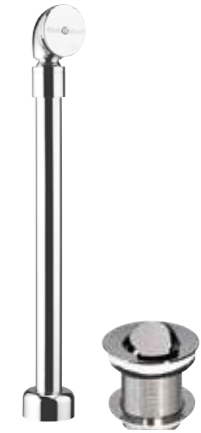

K-12-xx

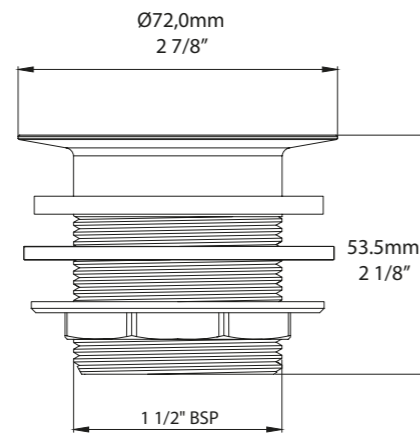

K-17-xx

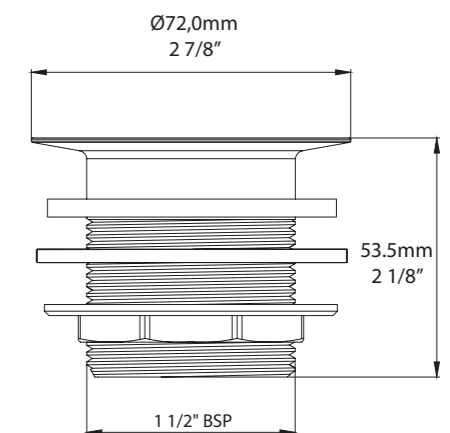
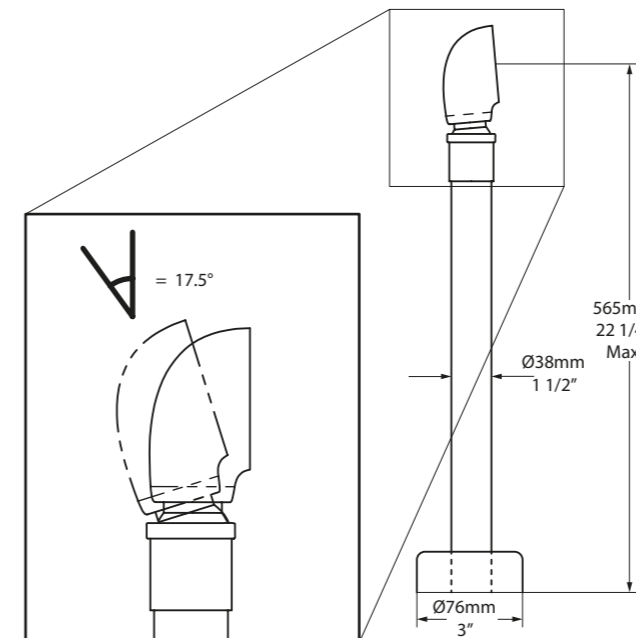



Kit 30

Vidage bonde moderne "clac-clac" pour baignoire avec trou de trop-plein.

Ab- und Überlaufgarnitur mit modernem Klickverschluss für Wannen mit Überlauf.

Sistema di scarico moderno con tappo a pressione per vasche con foro per troppopieno.

Overloopcombinatie met moderne push up-down voor baden met overloop.



K-30-xx

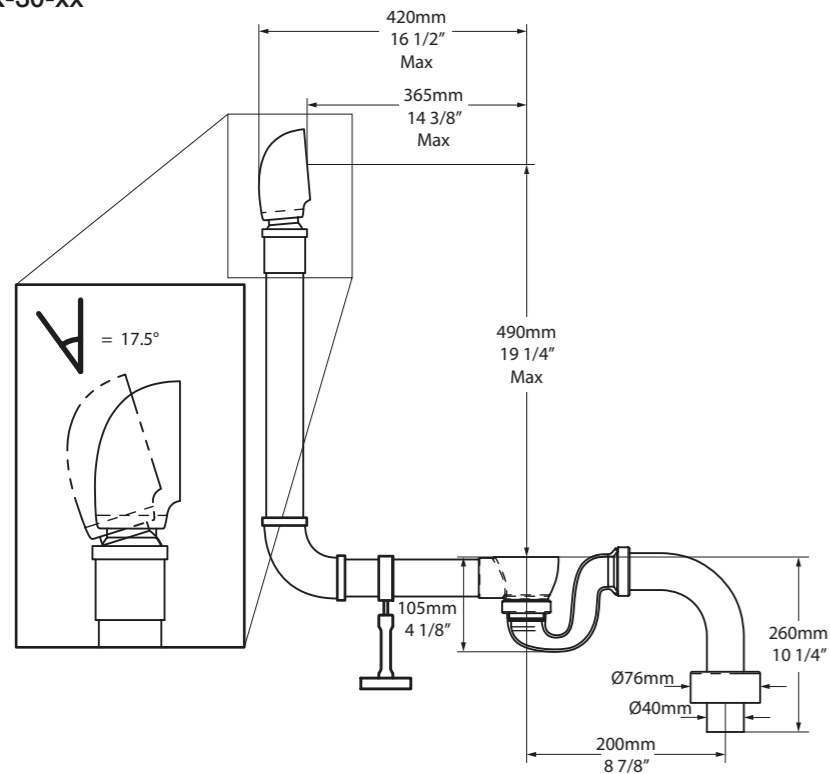

Depth of Water Seal Conforms to BS EN 274-1

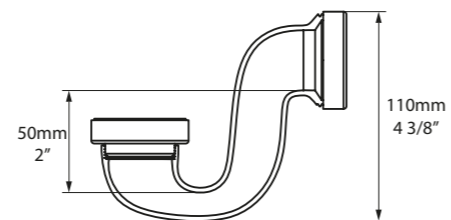

Kit 31

Vidage rétro "bonde et chaînette" pour baignoires avec trou de trop-plein.

Klassische „Kette & Stöpsel“- Ablaufgarnitur für Wannen mit Überlauf.

Sistema di scarico con tappo e catena tradizionali per vasche con foro per troppopieno.

Overloopcombinatie met traditionele ketting en plug voor baden met overloop.



K-31-xx

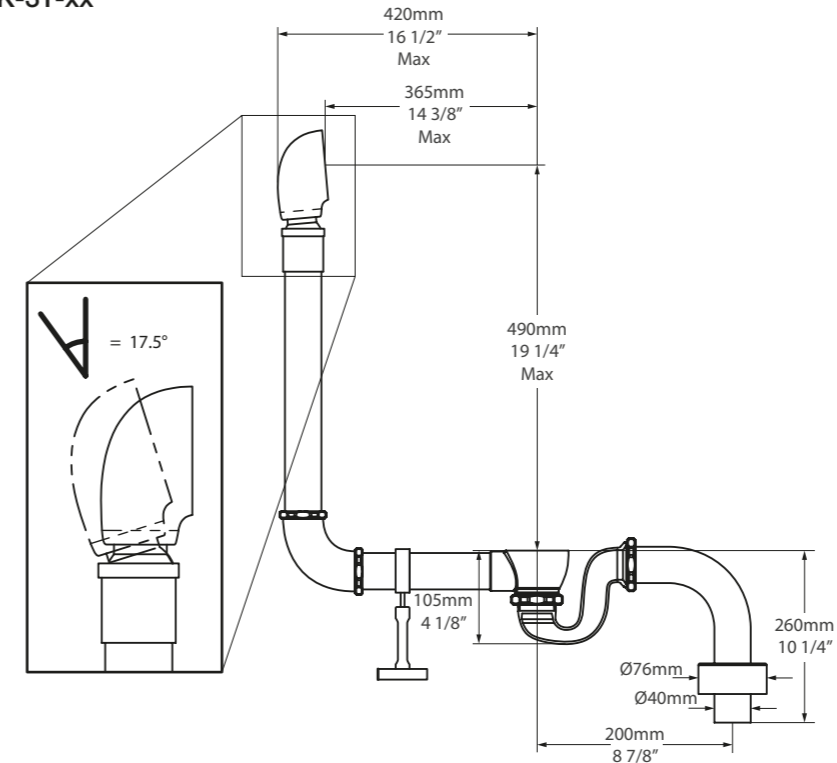

Depth of Water Seal Conforms to BS EN 274-1

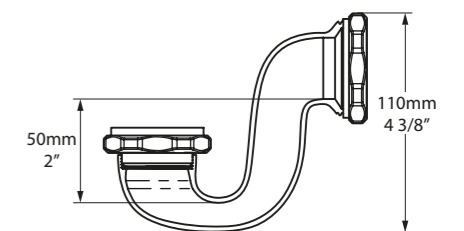

IntelliDrain

Nos "IntelliDrains" Kit 36 et Kit 40 fonctionnent avec une bonde "clic-clac" normale. Cependant, si la profondeur d'eau sécuritaire maximale est atteinte (36cm pour le Kit 36 et 40cm pour le Kit 40), la technologie brevetée à l'intérieur de l'unité déclenche l'ouverture de la bonde, permettant ainsi d'éviter un débordement. Une fois que le robinet est fermé, le kit de vidage intelligent permet le remplissage de la baignoire d'environ 26cm (30cm pour le kit 40) et se referme ensuite automatiquement, permettant au baigneur de profiter de son bain en toute tranquillité. Idéal pour les hôtels et les maisons avec enfants.

Unsere IntelliDrains Kit 36 und Kit 40 funktionieren wie ein normaler "klick-klack" Abfluss, aber wenn die maximale, sichere Wasserhöhe erreicht ist (36cm bei Kit 36 und 40cm bei Kit 40), öffnet die patentierte Automatik den Abfluss und vermeidet so ein Überlaufen. Ist das Wasser abgeschaltet, lässt der Abfluss das Wasser bis auf ca. 26cm Höhe ablaufen (30cm bei Kit 40), um sich dann wieder automatisch zu schließen, damit der Badende ein möglichst tiefes Eintauchen genießt. Ideal für Hotels oder Haushalte mit Kindern.

Il nostro kit 36 e Kit 40 "IntelliDrains" funzionano proprio come un normale scarico "click-clack"; ma se la massima profondità d'acqua di sicurezza viene raggiunta (36cm per il Kit 36 e 40cm per il Kit 40) allora la tecnologia brevettata all'interno dell'unità innesca la spina ad aprirsi evitando un'inondazione. Una volta che il rubinetto è spento lo scarico intelligente permette alla vasca di svuotarsi per circa 26cm (30cm per il Kit 40) per poi richiudersi automaticamente, permettendo a chi usa la vasca di godere un rilassante bagno. Perfetto per hotel o case con bambini.

Onze Kit 36 en Kit 40 "IntelliDrains" werken net als een normaal 'klik-klak'-afvoer; echter, als de maximale veilige waterdiepte wordt bereikt (circa 36 cm voor de Kit 36 en circa 40 cm voor de Kit 40), zorgt de gepatenteerde technologie in de unit ervoor dat de plug wordt geopend, wat een overstroming helpt voorkomen. Zodra de kraan is uitgeschakeld, zal de intelli-afval het waterniveau laten zakken tot ongeveer 26 cm (30 cm voor de Kit 40) en vervolgens automatisch opnieuw dicht, zodat de bader kan genieten van een diep bad. Perfect voor hoteltoepassingen of huizen met kinderen.

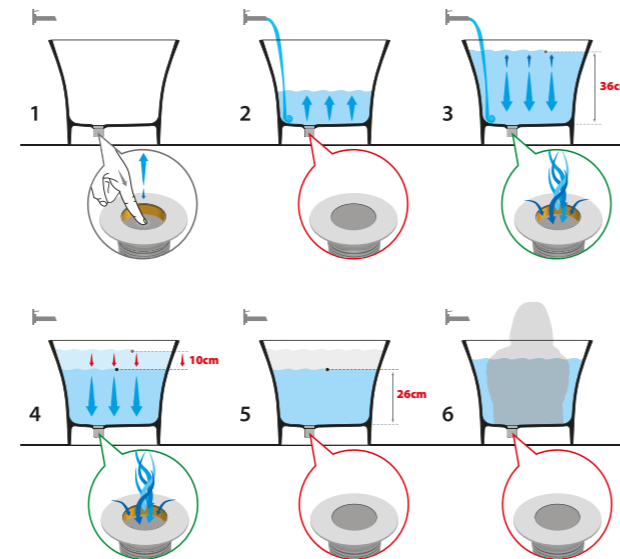

Kit 36

IntelliDrain. Environ 36cm de profondeur maximale. Convient aux baignoires Victoria + Albert sans trop-plein prépercé. NB. Ne convient pas pour la baignoire Cabrits.

Le Kit 36 est conçu pour être conforme à la norme BS EN 274-1.

IntelliDrain. Ca. 36cm maximale Tiefe. Passend für Victoria + Albert Wannen ohne vorgebohrten Überlauf. NB. Nicht geeignet für Cabrits Modelle.

Das Kit 36 wurde nach den Vorschriften der BS EN 274-1 Norm gestaltet.

IntelliDrain. Circa 36cm di profondità massima. Adatto per vasche Victoria + Albert senza un troppopieno preforato. NB. Non adatto per Cabrits.

Il Kit 36 e' progettato per essere conforme alla BS EN 274-1.

IntelliDrain. Tot ca. 36cm maximale diepte. Geschikt voor alle Victoria + Albert baden zonder vorgeboorde overloop. NB. Niet geschikt voor Cabrits.

De Kit 36 is ontworpen om te voldoen aan BS EN 274-1.

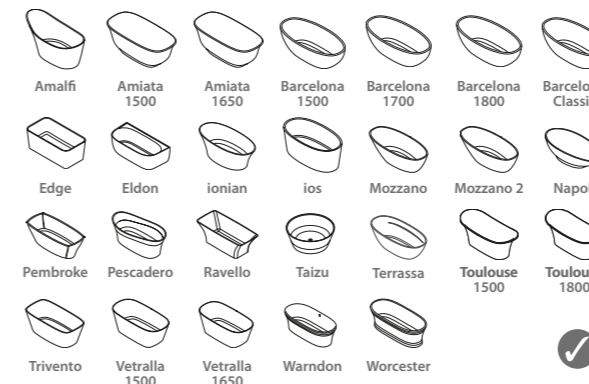

Kit 40

IntelliDrain. Environ 40cm de profondeur maximale. Convient aux baignoires Victoria + Albert sans trop-plein prépercé. NB. Ne convient pas pour les baignoires Amiata 1500, Barcelona 1500, Barcelona 1700, Barcelona 1800, Cabrits, Mozzano 2, Pescadero et Toulouse 1500.

Le Kit 40 est testé et répond aux exigences de la norme BS EN 274-1.

IntelliDrain. Ca. 40cm maximale Tiefe. Passend für Victoria + Albert Wannen ohne vorgebohrten Überlauf. NB. Nicht geeignet für die Modelle Amiata 1500, Barcelona 1500, Barcelona 1700, Barcelona 1800, Cabrits, Mozzano 2, Pescadero und Toulouse 1500.

Das Kit 40 wurde getestet und erfüllt die Anforderungen der BS EN 274-1 Norm.

IntelliDrain. Circa 40cm di profondità massima. Adatto per vasche Victoria + Albert senza un troppopieno preforato. NB. Non adatto per Amiata 1500, Barcelona 1500, Barcelona 1700, Barcelona 1800, Cabrits, Mozzano 2, Pescadero e Toulouse 1500.

Il Kit 40 e' testato e conforme BS EN 274-1.

IntelliDrain. Tot ca. 40cm maximale diepte. Geschikt voor alle Victoria + Albert baden zonder vorgeboorde overloop.

NB. Niet geschikt voor Amiata 1500, Barcelona 1500, Barcelona 1700, Barcelona 1800, Cabrits, Mozzano 2, Pescadero en Toulouse 1500.

De Kit 40 is getest volgens en voldoet aan BS EN 274-1.

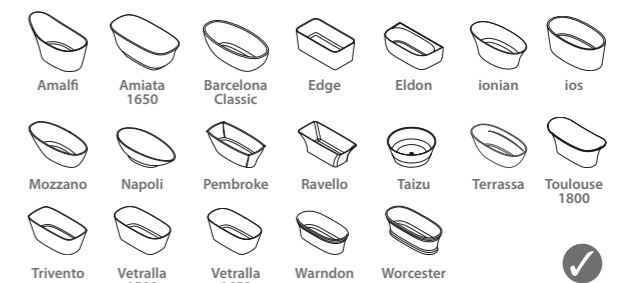

K-36-xx

K-40-xx

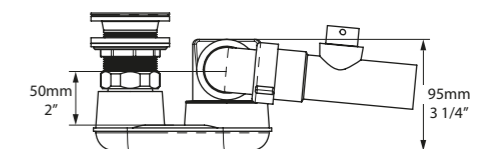
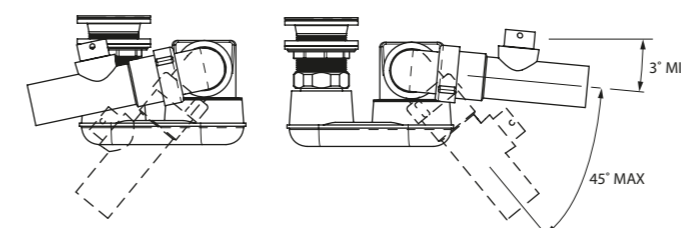
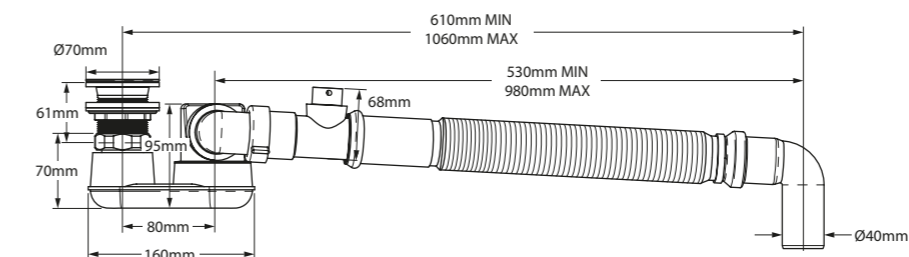

Depth of Water Seal Conforms to BS EN 274-1



Kit 60

Vidage de baignoire avec remplissage par le trop-plein.
 Robinetterie non incluse. Consulter nos gammes de robinetteries à encastrer.

Ab-und Überlaufgarnitur mit Wanneneinlauf. Für abgedeckten Installationen entwickelt.

Kontrollventile nicht enthalten. Beachten Sie die Armaturen Seiten, für Optionen zum versteckten Einbau.

Combinazione di riempimento per vasca e troppo pieno con tappo 'controllo a spinta'. Progettato per applicazioni nascoste.
 Valvole di controllo non incluse. Vedi le pagine per rubinetteria per le opzioni nascoste.

Overloop- en afvoercombinatie met badvulling, met 'push control' plug. Ontworpen voor verdede toepassingen.

Handgrepen niet inbegrepen. Zie paginas kranen omtrent inbouwopties

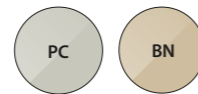

K-60-xx

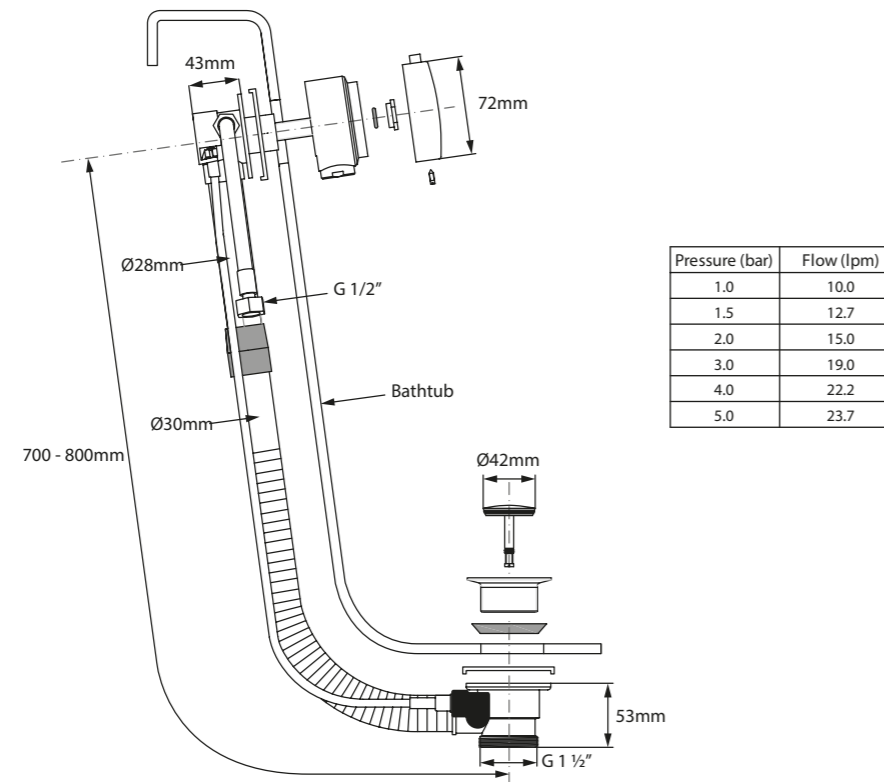

Kit 61

Vidage de baignoire automatique à câble.

Ab-und Überlaufgarnitur. Für abgedeckten Installationen entwickelt.

Combinazione scarico per vasca pop-up e troppopieno. Progettato per applicazioni nascoste.

Overloop- en afvoercombinatie met popup plug. Ontworpen voor verdede toepassingen.



K-61-xx

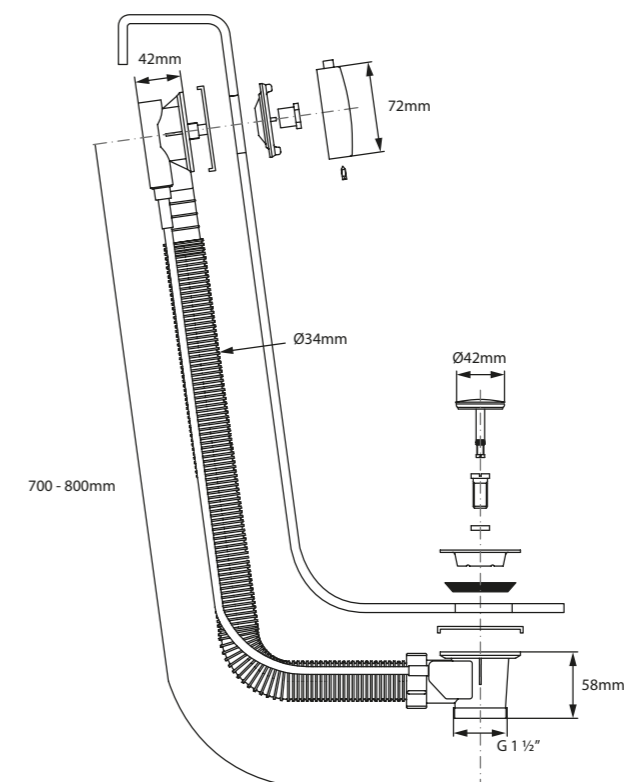

Accessories

Ajoutez la touche finale à votre salle de bains avec notre gamme d'accessoires de salle de bains luxueux. De l'élégant support de baignoire Tombolo avec porte-verres intégré à notre gamme de dossiers, la collection allie des matériaux de classe mondiale à une nouvelle conception.

Mit unseren luxuriösen Badezimmer-Accessoires verleihen Sie Ihrem Badezimmer den letzten feinen Schliff. Von der stilvollen Tombolo Wannenablage mit eingefräster Glashalterung bis hin zu unseren vielzähligen Wannen-Kissen – alle Produkte verbinden erstklassige Materialien und frisches Design.

Aggiungi gli ultimi tocchi alla tua stanza da bagno con la nostra gamma di lussuosi accessori da bagno. Dall'elegante Tombolo, accessorio per vasche con portabiccheri integrato, alla nostra gamma di poggiaschiena, la collezione fonde materiali di classe mondiale dal design innovativo.

Voeg de laatste hand toe aan uw badkamer met ons assortiment luxe badkameraccessoires. Van het stijlvolle Tombolo-badrek met geïntegreerde wijnglazen houders tot ons assortiment hoofd- en rugsteunen, combineert de collectie materialen van wereldklasse met een frisse vormgeving.



Chrome Poli.
Chrom Poliert.
Cromo Lucidato.
Chrom Glanzend.



Gris Anthracite.
Anthrazit.
Antracite.
Antraciet.



Stratifié Blanc.
Laminat Weiß.
Laminato Bianco.
Wit Laminaat.



Noyer Stratifié.
Walnusslaminat.
Noce Laminato.
Orzech Laminaat.



Noir.
Schwarz.
Nero.
Zwart.



Gris Clair.
Hellgrau.
Grigio Chiaro.
Licht Grijs.



Chêne Stratifié.
Eichenlaminat.
Rovere Laminato.
Eiken Laminaat.

BATH RACK

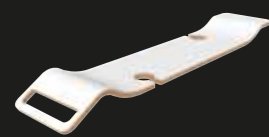

Tombolo 8
Page 260

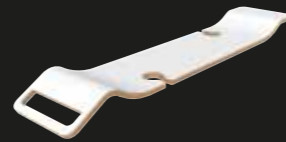

Tombolo 10
Page 260

Pont de baignoire / Badewannenbrücke / Mensola per vasca / Badbrug.

HEADREST

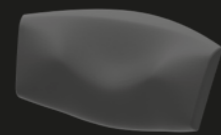

Amalfi Headrest
Page 264

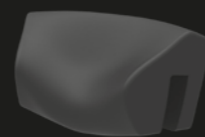

Napoli Headrest
Page 264

Repose-tête / Kopfstütze / Poggiatesta / Hoofdsteun.

BACKREST



Barcelona Backrest
Page 263



Luxury Backrest
Page 263

Dossier / Rückenlehne / Poggiaschiena / Rugsteun.

HANDLES



Handles
Page 265

Poignées pour baignoire / Wannengriffe / Maniglie per vasca / Handgrepen.

Tombolo 8

Pont de baignoire Design.

Moderne Badewannenbrücke.

Porta libro/vino contemporaneo per vasca.

Modern Badrek.

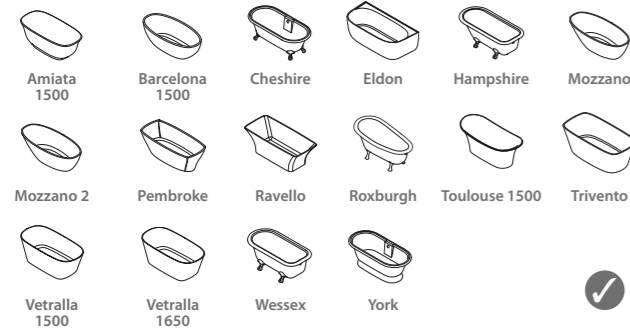

Tombolo 10

Pont de baignoire Design.

Moderne Badewannenbrücke.

Porta libro/vino contemporaneo per vasca.

Modern Badrek.

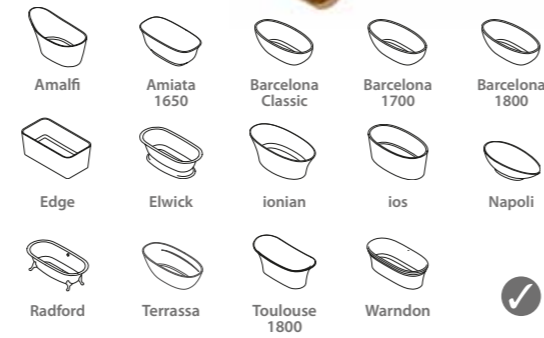

TOM-08-xx

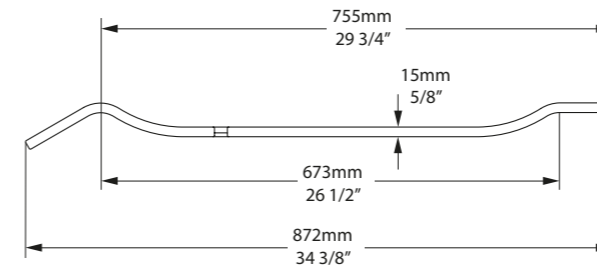

Side View

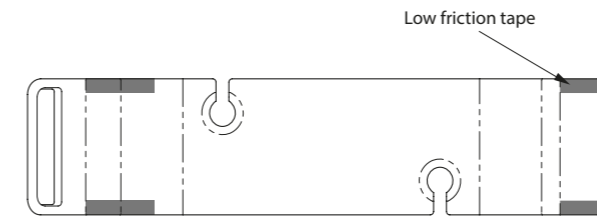

Underside View

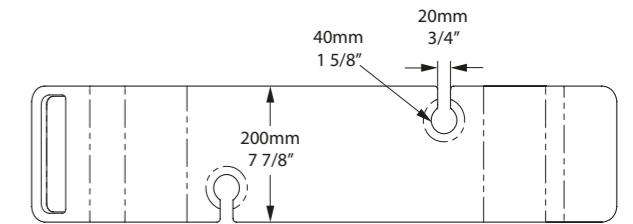

Top View

TOM-10-xx

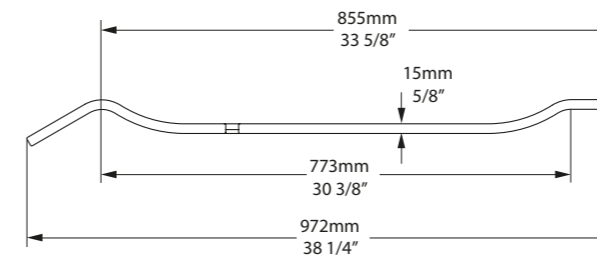

Side View

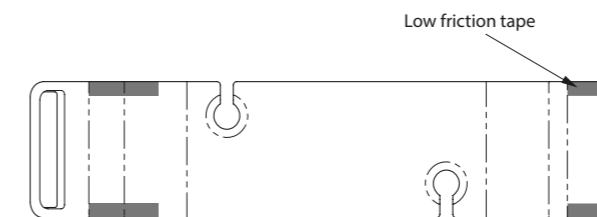

Underside View

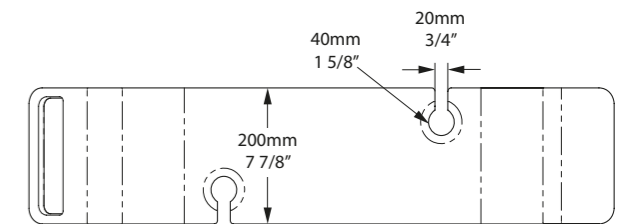

Top View

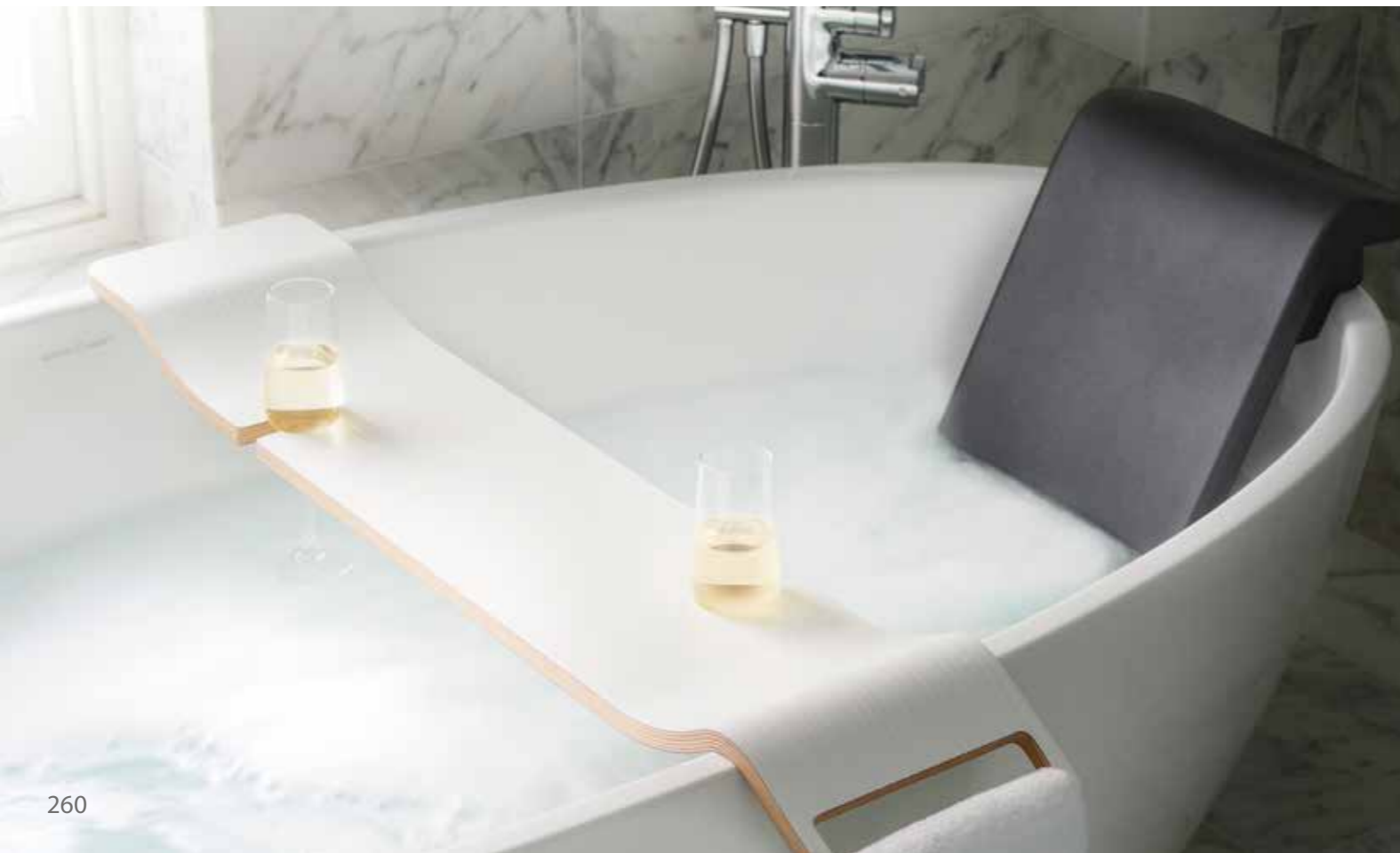



Barcelona Backrest

Dossier spécial pour baignoires Barcelona Classic, Eldon, Terrassa, Vetralla 1500 et Vetralla 1650

Exklusive Passform für die Wannenmodelle Barcelona Classic, Eldon, Terrassa, Vetralla 1500 und Vetralla 1650.

Disegno dedicato alle vasche Barcelona Classic, Eldon, Terrassa, Vetralla 1500 e Vetralla 1650.

Dedicated ontwerp voor de Barcelona Classic, Eldon, Terrassa, Vetralla 1500 en Vetralla 1650



BR-BAR-xx

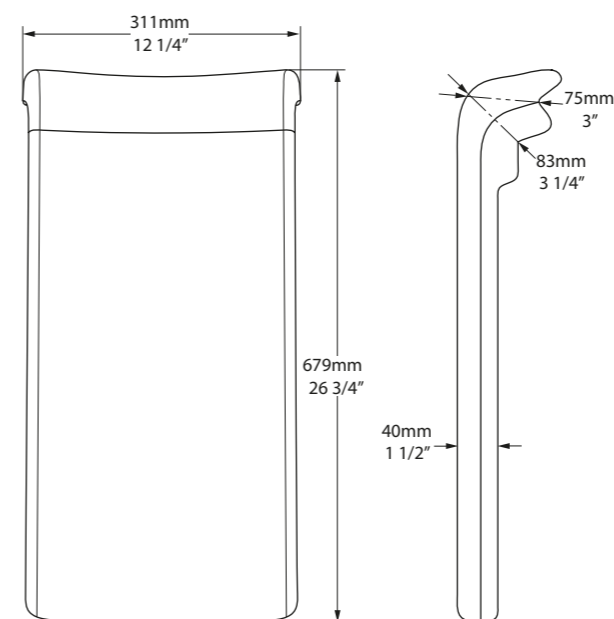

Front View

Side View

Luxury Backrest

Dossier spécial pour baignoires Barcelona 1700, Barcelona 1800, ios, Edge, Vetralla 1500 et Vetralla 1650.

Exklusive Passform für die Wannenmodelle Barcelona 1700, Barcelona 1800, ios, Edge, Vetralla 1500 and Vetralla 1650.

Progettato appositamente per le vasche a seduta Barcelona 1700, Barcelona 1800, ios, Edge, Vetralla 1500 e Vetralla 1650.

Dedicated ontwerp voor de Barcelona 1700, Barcelona 1800, ios, Edge, Vetralla 1500 en Vetralla 1650.



BR-SIT-xx

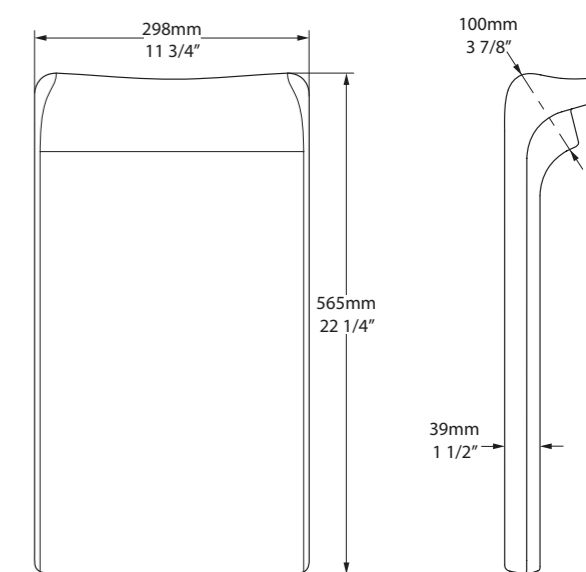

Front View

Side View

Amalfi Headrest

Repose-tête adapté - Noir.
 Abnehmbare Kopfstütze - Schwarz.
 Poggiatesta speciale - Nero.
 Speciaal hoofdkussen - Zwart.



HR-AML-xx

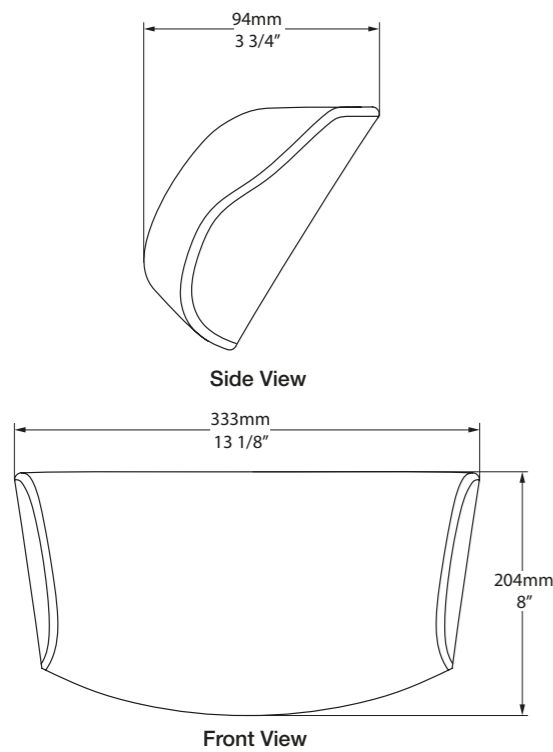

Napoli Headrest

Repose-tête adapté - Noir.
 Abnehmbare Kopfstütze - Schwarz.
 Poggiatesta speciale - Nero.
 Speciaal hoofdkussen - Zwart.



HR-NAP-xx

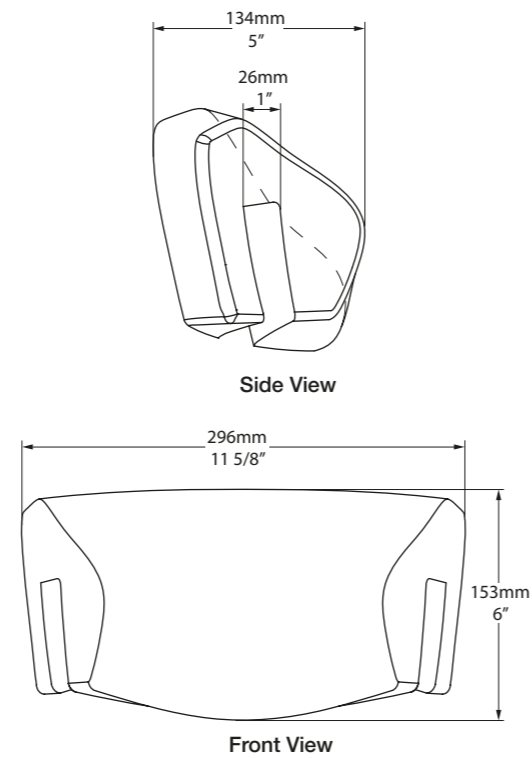

Handles

Lot de deux poignées
 Set mit 2 Griffen.
 Set di due maniglie.
 Set van twee handgrepen.



K-HAN01-xx

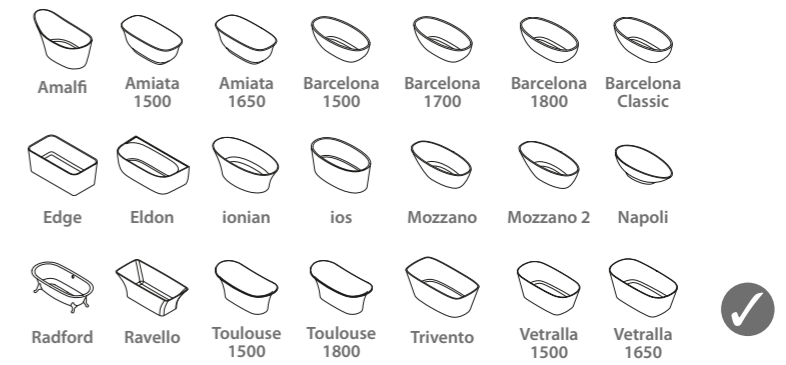
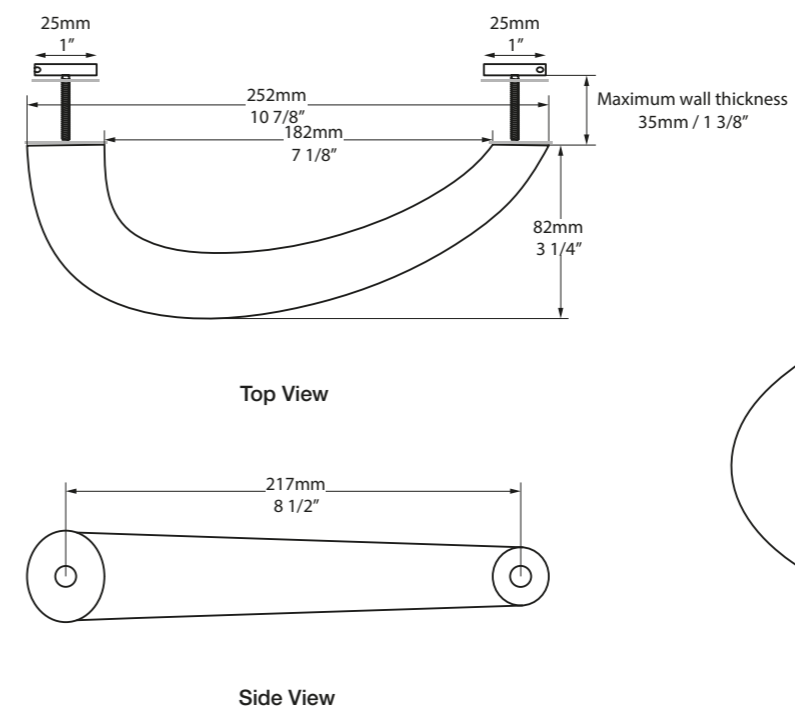

CAESARS PALACE
DUBAI



EDGE



WORLD SHOWCASE

HÔTEL LES
ROCHES ROUGES
SAINT-RAPHAËL, CÔTE D'AZUR, FRANCE

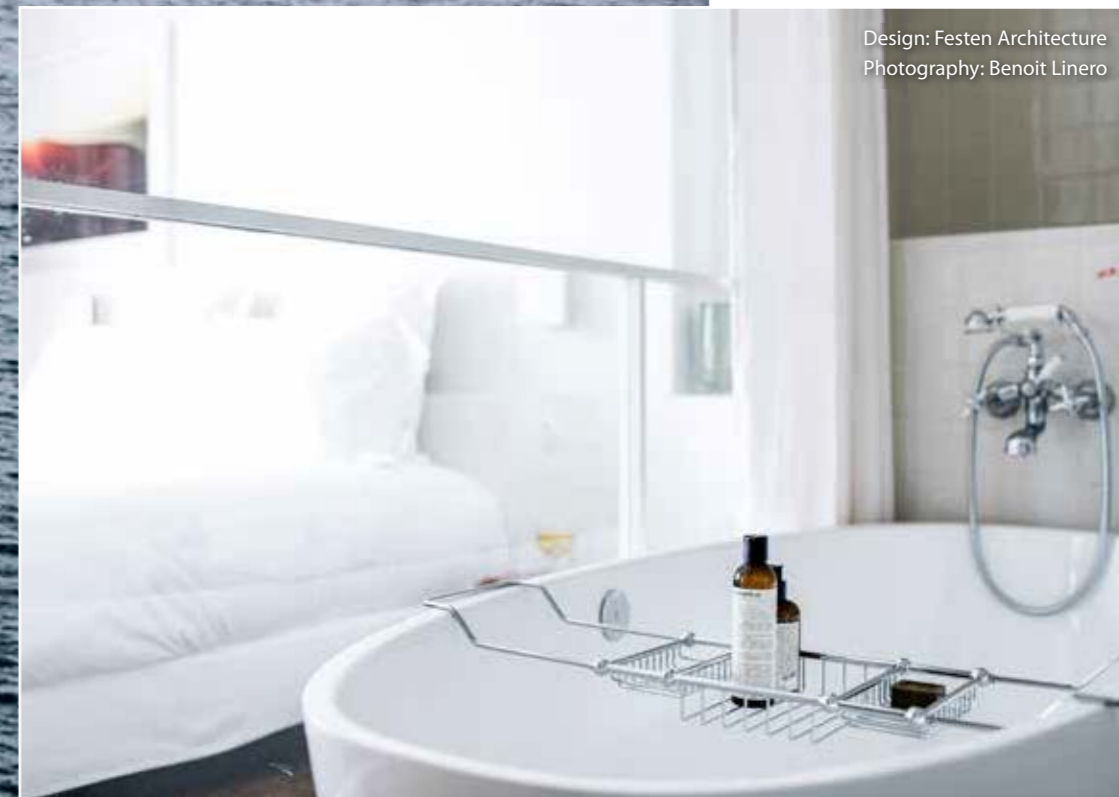

Design: Festen Architecture
Photography: Benoit Linero

BARCELONA CLASSIC



CEYLON TEA TRAILS

DIMBULA, SRI LANKA



Photography: Resplendent Ceylon

DRAYTON



BYRON BEACH ABODES

BYRON BAY, NSW,
AUSTRALIA



Design: Taliah Lowry
Photography: Jessie Prince

TERRASSA



BELMOND CADOGAN

CHELSEA,
LONDON, UK



Design: G.A Group
Photography: © Belmond

IOS



SIX SENSES IBIZA



ELWCK



A world of colour



Un monde haut en couleur

Personnalisez l'extérieur de nos baignoires et lavabos en îlot pour qu'il s'harmonise avec le reste du design de la salle de bains. Choisissez parmi une gamme de couleurs RAL en finition brillante ou mate. Chaque finition est réalisée en plusieurs couches à l'aide d'une peinture spéciale catalysée, avec un polissage manuel entre les applications. Cette technique donne une profondeur et un éclat exceptionnels à la finition, et est considérablement plus durable que les surfaces peintes à la main. Visitez www.vandabaths.com pour voir toute la gamme de couleurs.

i Veuillez prévoir un délai de livraison de 6 semaines pour toutes es baignoires et vasques peintes.

Veuillez vous adresser à un représentant commercial pour demander un formulaire de commande RAL.

Les baignoires Victoria + Albert définissent le terme "brillant" à un niveau de brillance de 90 %, et le terme "mat" à un niveau de brillance de 20 %.

Eine Welt voller Farben

Sie können das Äußere unserer freistehenden Wannen und Waschbecken nach Ihren Wünschen an den Rest Ihres Badezimmerdesigns anpassen. Wählen Sie aus unserem Angebot an RAL-Farben in glänzender oder matter Oberfläche. Jedes Finish wird in Form eines speziellen katalysierten Lacks in mehreren Schichten aufgetragen und nach jeder Schicht von Hand poliert. Diese Technik garantiert eine außergewöhnliche Tiefenwirkung und verleiht der Oberfläche ein Schimmern. Sie ist darüber hinaus bedeutend langlebiger als eine von Hand lackierte Oberfläche. Besuchen Sie www.vandabaths.com und schauen Sie sich das gesamte Farbangebot an.

i Bitte planen Sie eine Bearbeitungszeit von bis zu 6 Wochen für alle lackierten Wannen und Waschbecken ein.

Bitte sprechen Sie mit einem Verkaufsmitarbeiter und fordern Sie ein RAL-Bestellformular an.

Victoria + Albert definieren "glänzend" als 90 % Glanzniveau und "mat" als 20 % Glanzniveau.

Un mondo di colore

Personalizza l'esterno dei nostri lavabi da appoggio e delle vasche centro stanza per abbinarle allo stile del tuo bagno. Scegli tra una gamma di colori RAL in finiture lucide o opache. Ogni finitura è multistrato con una speciale vernice catalizzata, con lucidatura a mano. La tecnica si traduce in un'eccezionale profondità e lucentezza delle finiture ed è notevolmente più resistente rispetto alle superfici dipinte a mano. Visita www.vandabaths.com per visualizzare l'intera gamma di colori.

i i tempi di consegna per le vasche e i lavabi verniciati sono di circa 6 settimane.

Si prega di parlare con un rappresentante per richiedere un modulo di ordine RAL.

Le colorazioni Victoria + Albert ad effetto "lucido" hanno un livello di lucentezza del 90%; l'effetto "opaco" ha un livello di lucentezza del 20%.

Een wereld van kleur

Personaliseer de buitenkant van onze vrijstaande baden en wastafels om ze af te stemmen op de rest van het design van de badkamer. Kies uit een spectrum van RAL-kleuren in glans of matte afwerking. De afwerking bestaat uit meerdere lagen speciale, gekatalyseerde verf, na elke laag met de hand gepolijst. Deze techniek zorgt voor een uitzonderlijk diepe en glanzende afwerking, en is aanzienlijk duurzamer dan met de hand geschilderde oppervlakken. Bezoek www.vandabaths.com om het gehele kleurengamma te bekijken.

i Gelieve rekening te houden met een levertijd van 6 weken voor alle geschilderde baden en wastafels.

Neem contact op met een vertegenwoordiger om een RAL-bestelformulier aan te vragen.

Victoria + Albert Baths definieert 'glanzend' met een glansgraad van 90%, en 'mat' met een glansgraad van 20%.



La touche finale

Pour les grands projets résidentiels et hôteliers, Victoria + Albert est heureux de proposer un certain nombre d'options personnalisées pour répondre aux cahiers des charges.

Antidérapant

Toutes nos baignoires en îlot et encastrées peuvent être proposées avec un revêtement antidérapant en option pour plus de sécurité. Le revêtement présente une surface antibactérienne active, conforme à la norme ISO 22196. Il a été testé indépendamment par le TÜV selon la norme DIN 51097 : 1992-11. La surface peut être appliquée selon différents motifs et emplacements et est facile à nettoyer. Victoria + Albert offre une garantie de trois ans sur les revêtements antidérapants.

Perçage sur mesure

Toutes les baignoires en îlot modernes sont fournies en standard sans trop-plein pré-percé. Pour les kits de vidange tels que le Kit 17, Victoria + Albert propose désormais un service de perçage personnalisé. De plus, les trous de robinetterie peuvent être percés sur mesure sur les baignoires compatibles.

Pour plus d'informations et de prix sur l'antidérapant et notre service de perçage personnalisé, veuillez contacter info@vandabaths.com.

Abschließende Feinarbeiten

Für größere Projekte mit mehreren Räumen im Hotel- oder Wohnsektor bieten Viktoria + Albert gerne zusätzliche Optionen je nach den Vorgaben des Kunde an.

Anti-Rutsch

Alle unsere freistehenden Wannen und Einbauwannen können mit einer optionalen Anti-Rutsch-Beschichtung ausgestattet werden, die zusätzliche Sicherheit bietet. Die Beschichtung schließt eine antibakteriell aktive Oberfläche mit ein, die ISO 22196 entspricht. Sie ist vom TÜV unabhängig auf die Einhaltung von DIN 51097:1992-11 getestet worden. Die Oberfläche kann in verschiedenen Mustern und an verschiedenen Stellen aufgebracht werden und ist einfach zu reinigen. Victoria + Albert bieten eine dreijährige Garantie auf die Anti-Rutsch-Beschichtungen an.

Kundenspezifische Bohrungen

Alle modernen freistehenden Wannen werden standardmäßig ohne vorgebohrte Überläufe ausgeliefert. Für Ablaufgarnituren wie das Kit 17 bieten Victoria + Albert jetzt einen kundenspezifischen Bohrservice an. Dazu können in kompatible Wannen kundenspezifische Armaturlöcher gebohrt werden.

Wenn Sie mehr Informationen und Preisinformationen zur Anti-Rutsch-Beschichtung und zum kundenspezifischen Bohrservice haben möchten, schreiben Sie bitte eine entsprechende E-Mail an: info@vandabaths.com

Il tocco finale

Per grandi hotel e progetti residenziali, Victoria + Albert è lieta di offrire numerose opzioni di personalizzazione che incontrano ogni specifica esigenza.

Antiscivolo

Tutte le nostre vasche freestanding e da incasso possono essere dotate di una copertura opzionale antiscivolo per una maggiore sicurezza. La copertura è costituita da una superficie antibatterica attiva, conforme allo standard ISO 22196. È stata testata in modo indipendente da TÜV to DIN 51097: 1992-11. La copertura può essere applicata in vari schemi e posizioni ed è facile da pulire. Victoria + Albert offre una garanzia di tre anni sulle coperture antiscivolo.

Foratura personalizzata

Tutte le vasche freestanding moderne sono disponibili in versione standard senza la preforatura del troppo pieno. Per i kit di scarico come il Kit 17, Victoria + Albert ora offre un servizio di foratura personalizzato. In aggiunta, i fori degli scarichi possono essere personalizzati nelle vasche compatibili.

Per ulteriori informazioni e prezzi sulla copertura antiscivolo e il nostro servizio di foratura personalizzata, la invitiamo a contattare: info@vandabaths.com

De finishing touch

Voor grotere hotel- en woonprojecten met meerdere kamers biedt Victoria + Albert een aantal opties op maat aan, afhankelijk van de specificaties.

Antislip

Al onze vrijstaande en inbouwbaden kunnen voorzien worden van een optionele antislip-laag voor extra veiligheid. De coating heeft een antibacterieel oppervlak dat voldoet aan ISO 22196. Het is onafhankelijk getest door TÜV volgens DIN 51097: 1992-11. Het oppervlak kan in verschillende patronen en op verschillende plaatsen worden aangebracht en is gemakkelijk te reinigen. Victoria + Albert biedt drie jaar garantie op antislip coatings.

Boren op maat

Alle moderne vrijstaande baden worden standaard geleverd zonder voorgeboorde overloop. Voor afvoeren zoals de Kit 17 biedt Victoria + Albert nu een boorservice op maat. Bovendien kunnen bij compatibele baden kraangaten op maat worden geboord.

Voor meer informatie en prijzen van antislip en onze boorservice op maat kunt u contact opnemen met info@vandabaths.com



QUARRYCAST™ finishes

Nos finitions

Nos baignoires et nos lavabos sont disponibles en deux finitions : brillante et mate. Les deux finitions sont coulées dans notre matériau QUARRYCAST™, qui est naturellement chaud au toucher, d'une durabilité rassurante, et garanti pendant 25 ans. Et qui plus est, elles peuvent être personnalisées avec notre sélection de couleurs RAL.

Brillant (SW) Notre finition phare est brillante à l'intérieur comme à l'extérieur. Polie à la main pour produire un lustre magnifiquement lisse, notre finition brillante est leader du marché depuis plus de 25 ans. Toutes les baignoires et lavabos de notre gamme sont disponibles dans notre finition brillante.

Matt (SM) La finition Mate Fabriquée dans le moule, et non par des enduits ou des glaçages, elle est "100%" mate. Elle a un toucher velouté, doux contre la peau. Notre finition mate est disponible sur une sélection de nos baignoires et lavabos :

Unsere Oberflächen

Unsere Wannen und Waschbecken sind in zwei Oberflächenversionen erhältlich: glänzend und matt. Beide Oberflächen bestehen aus unserem charakteristischen QUARRYCAST™ Verbundmaterial, das von Natur aus berührungswarm, zuverlässig langlebig und mit einer 25-jährigen Garantie ausgestattet ist. Dazu kommt, dass Sie aus unserem Angebot an RAL-Farben Ihre persönliche Wunschfarbe wählen können.

Glänzend (SW) Unsere glänzenden Oberflächen glänzen auf der Außenseite und der Innenseite. Mit dem durch Handpolitur erzeugten wunderbar sanft schimmernden Glanz sind unsere glänzenden Oberflächen seit über 25 Jahren marktführend. Alle unsere Wannen und Waschbecken sind mit glänzender Oberfläche erhältlich.

Matt (SM) Die matte Oberfläche von Viktoria + Albert ist anders. Sie entsteht beim Guss und nicht durch Lackschichten oder Glasuren und ist '100%' matt. Sie fühlt sich samtig an und ist sanft auf der Haut. Unsere matte Oberfläche i

Le nostre finiture

Le nostre vasche e i lavabi sono disponibili in due finiture; lucide e opache. Entrambe le finiture sono stampate con il nostro materiale distintivo QUARRYCAST™, che è naturalmente caldo al tatto, duraturo e garantito per 25 anni. Inoltre possono essere personalizzate con la selezione di colori RAL.

Lucido (SW): la nostra finitura è lucida sia all'interno che all'esterno. Rifinita a mano per produrre una magnifica lucentezza, la nostra finitura liscia è leader del mercato da oltre 25 anni. Ogni vasca e lavabo del nostro catalogo è disponibile nella finitura Lucida.

Opaco (SM): la finitura Victoria + Albert opaca è differente. Fatta nello stampo, e non placcata o smaltata, è opaca al "100%". Offre una sensazione vellutata, gentile al tatto. La nostra finitura Opaca è disponibile per una selezione di vasche e lavabi:

Onze afwerkingen

Onze baden en wastafels zijn verkrijgbaar in twee afwerkingen; glanzend en mat. Beide afwerkingen zijn gegoten in ons unieke QUARRYCAST™-materiaal, dat van nature warm aanvoelt, uitzonderlijk duurzaam is en een garantie van 25 jaar biedt. Daarnaast kunnen ze aan uw persoonlijke smaak aangepast worden met onze selectie van RAL-kleuren.

Glanzend (SW) Onze kenmerkende afwerking is glanzend aan de binnen- en buitenkant. Dankzij de prachtige gladde glans die verkregen wordt door met de hand te polijsten, is onze glanzende afwerking al meer dan 25 jaar marktleider. Elke badkuip en wastafel in ons assortiment is verkrijgbaar in onze glanzende afwerking.

Mat (SM) De matte afwerking van Victoria + Albert is anders. Deze afwerking ontstaat in de gietvorm, niet door coatings of glazuur; het is '100%' mat. Het voelt fluweelzacht aan op de huid. Onze matte afwerking is beschikbaar voor een selectie van onze baden en wastafels:

Baignoire / Wanne / Vasca / Bad:

Amalfi	ios
Amiata 1500	Mozzano
Amiata 1650	Mozzano 2
Barcelona 1500	Napoli
Barcelona 1700	Toulouse 1500
Barcelona 1800	Toulouse 1800
Barcelona Classic	Vetralla 1500
ionian	Vetralla 1650

Vasque / Waschbecken / Lavabo / Wasbak:

Amalfi 55	Barcelona 64
Barcelona 48	ios 54
Barcelona 55	Napoli 57

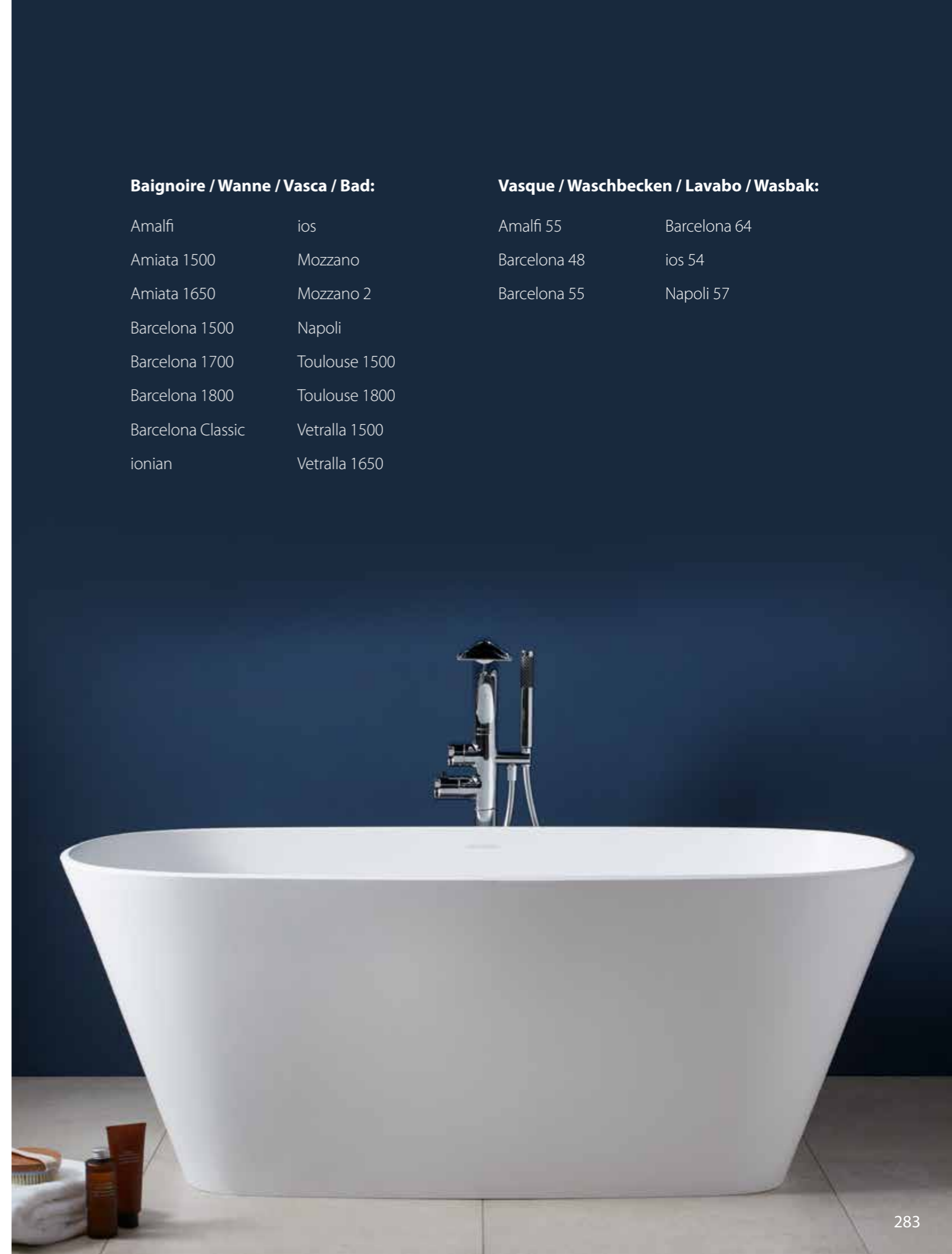

Next steps

Trouvez-nous en ligne

Pour plus d'informations sur nos produits, y compris les fichiers CAO 2D et 3D, les instructions de montage et les conseils d'entretien et de nettoyage, visitez notre site Web www.vandabaths.com. Vous y découvrirez également notre outil «Trouvez un Showroom» qui vous permet de localiser la salle d'exposition la plus proche, où que vous soyez dans le monde.

Si vous cherchez des idées de design de salle de bain, pourquoi ne pas jeter un coup d'œil à la section «Inspiration» de notre site Web? Vous pouvez également nous suivre sur Instagram, Twitter et Pinterest, où nous partageons tous les jours de superbes projets de salles de bains.

Zu unserer Website

Weitere Informationen zu unseren Produkten, inklusive 2D und 3D CAD Dateien, Montageanleitungen, Wartung- und Pflegeanleitungen finden Sie auf unserer Website

www.vandabaths.com. Dort finden Sie auch Hinweise zu den Showrooms in Ihrer Nähe – wo immer Sie sich zur Zeit befinden.

Falls Sie ein komplett neues Badezimmer planen, finden Sie auf unserer Website eine Fülle an Inspirationen. Folgen Sie uns zudem auf Instagram, Twitter und Pinterest, wo wir täglich neue, atemberaubende Badprojekte posten.



www.vandabaths.com



@victoria_albert_baths



@Vanda_Baths



Victoria + Albert Baths



Victoria + Albert Baths

Trovaci online

Per maggiori informazioni sui nostri prodotti, inclusi 2D e 3D Cad files, istruzioni di montaggio e cura e suggerimenti sulla pulizia, visita il nostro sito web www.vandabaths.com. Scopirai inoltre il nostro utile "Trova una sala mostra" che ti permette di trovare la tua sala mostra piu' vicina ovunque tu sia nel mondo.

Se cerchi idee di design per spazi da bagno, dai un'occhiata alla sezione del nostro sito web "Ispirazione". Ci puoi inoltre seguire su Instagram, Twitter and Pinterest, dove condividiamo stupendi progetti da bagno ogni giorno.

Vind ons online

Bezoek onze website www.vandabaths.com voor meer informatie over onze producten, waaronder 2D- en 3D CAD-bestanden, montage-instructies en onderhoudsvorschriften. Je zult ook onze handige tool "Vind een dichtsbijzijnde showroom" ontdekken, waar je ook bent.

Als u op zoek bent naar ideeën voor het ontwerpen van de badkamer, neem dan een kijkje op de sectie 'Inspiratie' op onze website. Je kunt ons ook volgen op Instagram, Twitter en Pinterest, waar we dagelijks prachtige badkamerprojecten delen.

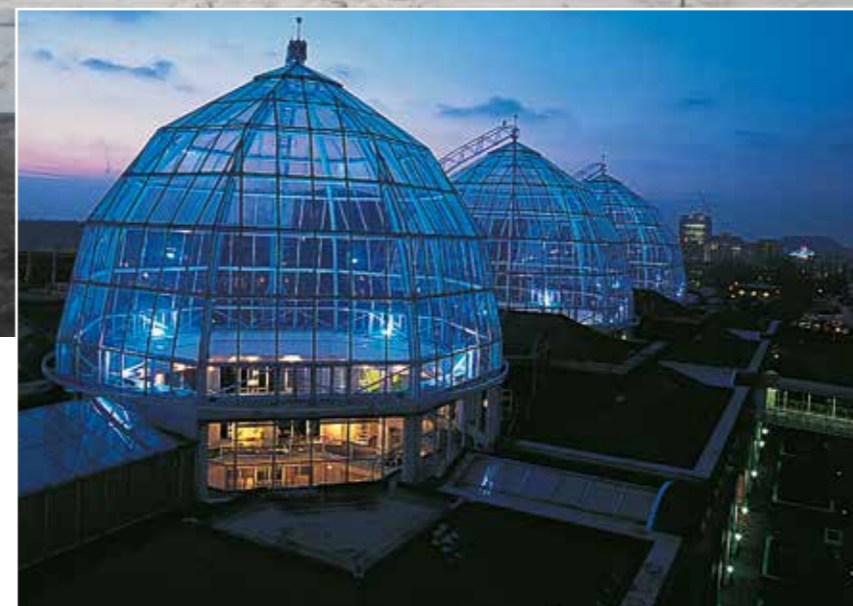

Specification

SHOWROOM

House of Rohl
316-318 North Dome, Design Centre Chelsea Harbour, London. SW10 0XE
Tel: +44 (0)207 351 4378



Terms & conditions

Les couleurs et finitions exactes des produits peuvent varier de celles montrées dans ce catalogue. Nous recommandons toujours que les consommateurs se rendent chez leur revendeur Victoria + Albert le plus proche. Les coordonnées de ceux-ci peuvent être obtenues par le biais de notre site

www.vandabaths.com

Victoria + Albert poursuivent une politique de développement continu. Pour cette raison, les données techniques peuvent être amenées à changer sans avis préalable. Toutes les dimensions montrées sur ce tarif le sont à titre indicatif. Etant es produits moulés, leur taille peut varier dans une marge de +/-5%.

Die exakte Farbe und Oberflächenfinish der Produkte können etwas von den im Katalog abgebildeten Modellen abweichen. Darum empfehlen wir dem Kunden wärmstens den nächstgelegenen Victoria + Albert Händler zu besuchen. Eine Händlerliste erhalten Sie über unsere Website

www.vandabaths.com

Victoria + Albert betreibt eine kontinuierliche Weiterentwicklung und Verbesserung Ihrer Produkten, wobei also Produkt spezifikationen ohne vorherige Ankündigung geändert werden können. Alle aufgeführten Maße sind Nennmaße. Als gusserzeugte Produkte, können Größenabweichungen im Toleranzbereich von +/- 5% vorkommen, welche in der Norm ANSI-A112.19.4M angegeben sind.

Il colore esatto e la finitura dei prodotti possono variare da quelli illustrati in questa brochure. Consigliamo sempre che i consumatori visitino il rivenditore Victoria + Albert autorizzato più vicino, i cui dettagli sono disponibili attraverso il nostro sito web, www.vandabaths.com

Victoria + Albert persegue una politica di continuo sviluppo e miglioramento e, come tale, le specifiche del prodotto possono essere modificate senza preavviso. Tutte le dimensioni delle vasche indicate qui sono espote unicamente come guida. Essendo prodotti da colata sono soggetti ad una variazione di dimensioni +/- 5%.

De exacte kleur en afwerking van producten kunnen afwijken van de afbeeldingen in deze brochure. Wij raden daarom altijd aan dat de consumenten de dichtstbijzijnde Victoria + Albert dealer bezoekt, waarvan de details worden verkregen via onze website, www.vandabaths.com

Victoria + Albert streeft naar een beleid van continue ontwikkeling en verbetering. Daardoor kunnen product-specificaties worden gewijzigd zonder voorafgaande kennisgeving. Alle hier vermelde badafmetingen zijn slechts als indicatie vermeld. Als gegoten producten zijn zij onderhevig aan een variatie in grootte van +/- 5%.



Foxhill Manor



HOUSE OF ROHL

PERRIN & ROWE | RIOBEL
SHAWS | VICTORIA + ALBERT

Bienvenue chez House of Rohl®

The House of Rohl est un ensemble de marques artisanales réputées pour leurs qualités artistiques et leur héritage culturel. Plus d'informations sur houseofrohl.uk

Willkommen im House of Rohl®

The House of Rohl ist eine Kollektion von Manufakturen, die für ihre Handwerkskunst und Tradition bekannt sind. Entdecken Sie mehr unter houseofrohl.uk

Benvenuto da House of Rohl®

House of Rohl è una collezione di marchi artigianali riconosciuti per il gusto artistico e il patrimonio culturale che li contraddistingue. Scopri di più su houseofrohl.uk

Welkom bij the House of Rohl®

Het House of Rohl is een collectie van artisanale merken die erkend zijn voor hun vakmanschap en hun erfgoed. Ontdek meer op houseofrohl.uk

PERRIN & ROWE

Robinetteries et sanitaires

Dans la fonderie anglaise de Perrin & Rowe, le laiton en fusion à 1000°C est coulé à la main dans des moules sophistiqués. Le laiton de qualité supérieure est utilisé pour garantir un moulage parfait. Chaque pièce est usinée avec précision avant d'être polie à la main. Cette fusion de la technologie et de l'artisanat est à l'origine de la réputation de qualité inégalée de Perrin & Rowe.

Messing- und Sanitärarmaturen

In der englischen Gießerei Perrin & Rowe wird geschmolzenes Messing bei 1000°C von Hand in komplexe Formen gegossen. Dabei kommt nur das feinste Messing zum Einsatz, um einen perfekten Guss zu garantieren. Jedes einzelne Stück wird präzise maschinell bearbeitet und dann von Hand poliert. Diese Fusion von Technologie und Handwerkskunst ist das Fundament des unangefochtenen Rufs von Perrin & Rowe, nur höchste Qualität zu liefern.

Articoli in ottone e sanitari

Nella fonderia inglese di Perrin & Rowe, l'ottone fuso viene versato a mano a 1.000°C in stampi con lavorazioni complesse. Viene utilizzato ottone della migliore qualità per assicurare una fusione perfetta. Ogni pezzo è lavorato con precisione prima di essere lucidato a mano. Questo connubio tra tecnologia e sapiente abilità artigianale conferisce a Perrin & Rowe una reputazione ineguagliabile in fatto di qualità.

Kraanwerk en sanitair

In de Engelse gieterij Perrin & Rowe wordt gesmolten messing met de hand in gespecialiseerd mallen gegoten bij temperaturen van 1.000°C. Hiervoor wordt messing van de beste kwaliteit gebruikt om een perfecte afgietsel te garanderen. Elk stuk is machinaal met precisie bewerkt en daarna met de hand gepolijst. Deze combinatie van technologie en vakmanschap is de reden achter de ongeëvenaarde reputatie voor kwaliteit van Perrin & Rowe.

RIOBEL

Robinetteries contemporaines

C'est au Québec que la culture européenne répond aux aspirations nord-américaines. Là-bas, Riobel conçoit des robinetteries uniques et innovantes, inspirées des formes sculpturales de l'architecture contemporaine. L'ingénierie avancée offre des performances et une fiabilité de pointe. Riobel offre un design de luxe pour un habitat moderne.

Zeitgenössische Armaturen

In Quebec treffen europäische Kultur und nordamerikanische Ambition aufeinander. Hier entwirft Riobel unverwechselbare und innovative Armaturen, inspiriert von den Formgebungen zeitgenössischer Architektur. Fortgeschrittene Ingenieurskunst kreiert branchenführende Leistung und Zuverlässigkeit. Riobel bietet Luxusdesign für das moderne Leben.

Articoli di ottone dal gusto contemporaneo

Il Quebec rappresenta il luogo dove cultura europea e ispirazioni del Nord America si incontrano. Proprio qui Riobel progetta articoli in ottone innovativi e dal design unico, ispirati alle forme scultoree dell'architettura contemporanea. L'ingegneria più avanzata garantisce prestazioni e affidabilità leader nel settore. Riobel offre un design di lusso ideale per la vita moderna.

Moderne kranen

Quebec is de plaats waar de Europese cultuur en de Noord-Amerikaanse aspiratie elkaar ontmoeten. Hier ontwerpt Riobel onderscheidende en innovatieve kranen, geïnspireerd door de expressieve vormen van de hedendaagse architectuur. Geavanceerde engineering zorgt voor toonaangevende prestaties en betrouwbaarheid. Riobel biedt luxueus design voor het moderne leven.

SHAWS

Éviers en argile réfractaire

Lorsque Arthur Shaw identifia les déchets extraits de la mine de Darwen comme de l'argile réfractaire, il créa Shaws of Darwen pour s'en servir. Plus de 120 ans après, dans la même usine du nord de l'Angleterre, l'argile réfractaire de haute résistance de Shaws est cuite à une température plus élevée et plus longtemps afin de produire des éviers et des lavabos dotés d'une finition incroyablement durable.

Schamottstein-Spülen

Als Arthur Shaw herausfand, dass der Abraum aus der Kohlengrube in Darwen Schamottstein war, gründete er Shaws of Darwen, um diesen Rohstoff zu nutzen. Über 120 Jahre später wird in derselben Fabrik im Norden Englands Shaws' hochbelastbarer Schamottstein besonders heiß und lange erhitzt, um Küchenspülen und Waschbecken mit einer unglaublich widerstandsfähigen Oberfläche zu fertigen.

Lavelli in argilla refrattaria

Quando Arthur Shaw scoprì che il materiale di scarto estratto dalla miniera di Darwen era argilla refrattaria, decise di utilizzarla come materiale di lavorazione nella sua nuova azienda Shaws of Darwen. Più di 120 anni dopo, nella stessa fabbrica del nord dell'Inghilterra, l'argilla refrattaria ad alta resistenza viene lavorata con cotture più lunghe e a temperature più elevate per produrre lavelli da cucina e lavabi da bagno con finiture incredibilmente resistenti.

Keramische keukenspoelbakken

Toen Arthur Shaw ontdekte dat het afvalmateriaal van de kolenmijn in Darwen als vuurvaste klei gebruikt kan worden, richtte hij Shaws of Darwen op om er gebruik van te maken. Meer dan 120 jaar later, en nog steeds in dezelfde fabriek in het noorden van Engeland, wordt Shaws' Heavy Duty Fireclay heter en langer gestookt om spoelbakken voor keukens en badkamers te produceren met een ongelooflijk duurzame afwerking.

victoria ⊕ albert®

www.vandabaths.com

Head Office

Victoria + Albert Baths Ltd
Unit B, Hortonwood 37
Telford, Shropshire
TF1 7XT
United Kingdom

Tel: +44 (0)1952 221100

Fax: +44 (0)1952 221111

info@vandabaths.com

Specification Showroom

House of Rohl
316-318 North Dome
Design Centre
Chelsea Harbour
London
SW10 0XE
United Kingdom

www.vandabaths.com

 @victoria_albert_baths

 @Vanda_Baths

 Victoria+Albert Baths